LYC

LYC
Bearings

LYC Bearings

General Catalogue





Scan code and
download this book

Rolling Bearings

© Copyright LYC 2016

The copyright of this catalogues are owned by LYC and may not be reproduced unless permission is granted. Every cares has been taken to ensure the accuracy of the information contained in this catalogue but no liability can be accepted for any errors or omissions.

Printed in China

LYC[®]

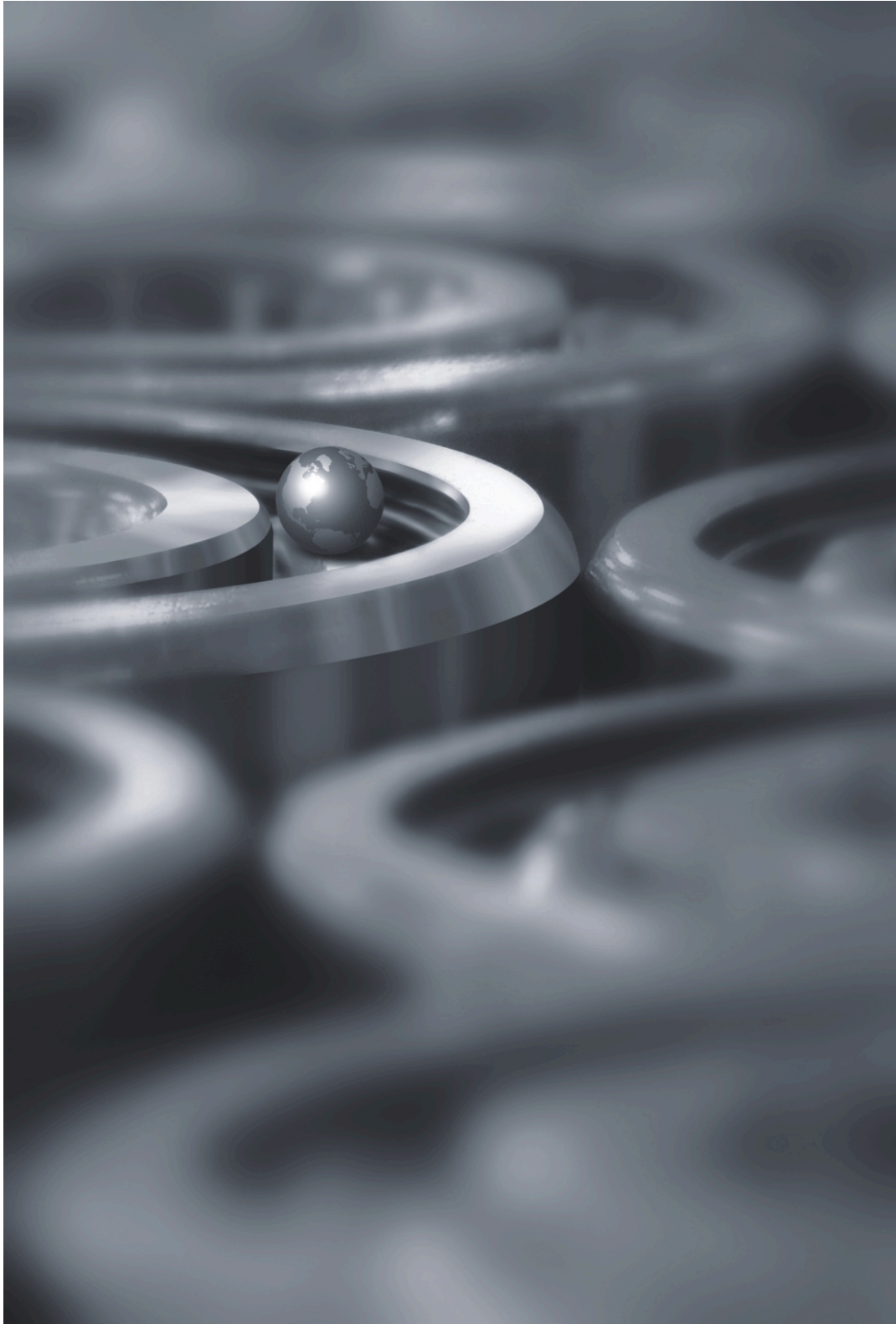

Bearing Basic Knowledge	001
Deep Groove Ball Bearings	097
Self-Aligning Ball Bearings	141
Cylindrical Roller Bearings	149
Spherical Roller Bearings	209
Needle Roller Bearings	237
Angular Contact Ball Bearings	257
Taper Roller Bearings	297
Thrust Ball Bearings	367
Thrust Roller Bearings	389
Hub Unit, Redirection, Pump, Clutch Bearings	409
Other Special Bearings	423
Balls and Rollers	455

1. Basic Structure and Types of Rolling Bearing

1.1 Bearing Terms of Rolling Bearing Structure

Radial bearing

Basic terms of radial bearing structure are shown in Fig. 1.1

Thrust bearing

Basic terms of thrust bearing structure are shown in Fig. 1.2

Bearing installment

Basic terms for bearing installment are shown in Fig 1.3

Radial bearing

1. Inner ring
2. Outer ring
3. Rolling element (steel ball, cylindrical roller, needle roller, taper roller, spherical roller)
4. Cage
5. Seal (dustproof) fixture (Including seal ring and shield cover)
6. Outer diameter
7. Inner diameter
8. Outer diameter (flange) of inner ring

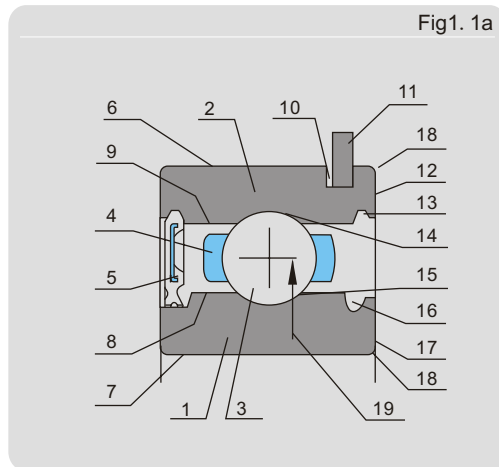

Radial bearing

9. Inner diameter (flange) of outer ring
10. Snap groove
11. Snap ring
12. Outer face
13. Seal (dustproof) groove
14. Raceway of outer ring
15. Raceway of inner ring
16. Seal (dustproof) groove
17. Inner face
18. Assembling corner
19. Average diameter of bearing
20. Assembling height
21. Direction flange
22. Flange
23. Contact Angular

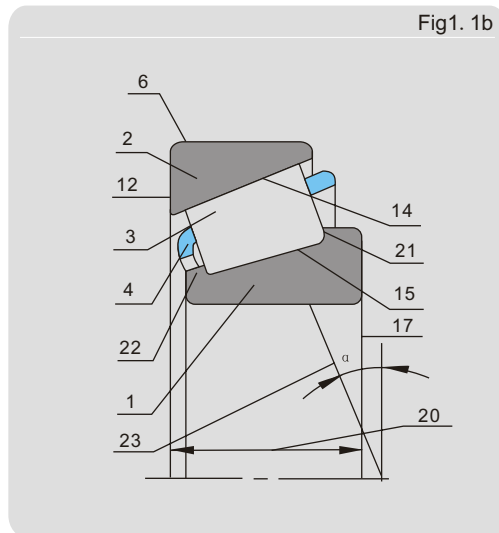
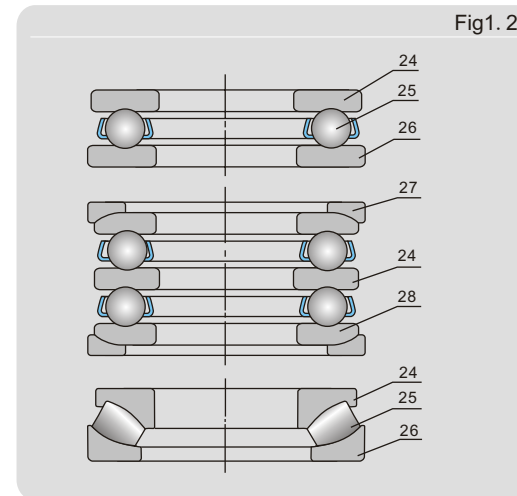

Fig1. 2



Thrust Bearing

24. Shaft washer
25. Rolling element-cage assembly
26. Housing washer
27. Aligning seat washer
28. Aligning housing washer

Fig1. 3

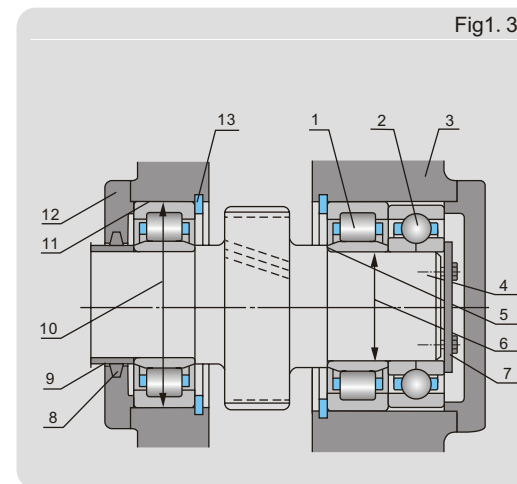

Bearing configure

1. Cylindrical roller bearing
2. Four-point contact ball bearing
3. House
4. Shaft
5. Shaft shoulder
6. Shaft journal
7. Lock plate
8. Radial shaft seal
9. Space ring
10. Aperture
11. House hole
12. Cover
13. Snap ring

1.2 Rolling Bearing Structure

Basic structures of rolling bearing consist of inner ring, outer ring, rolling element and cage.

1.2.1 Structure type of rolling bearing

1.2.1.1 As per the shape of rolling element:

- Ball bearing (Fig.4.1)
- Roller bearing (Fig.4.7)

1.2.1.2 As per load direction:

- Radial bearing (Fig.4.1)
- Thrust bearing (Fig.1.4.3)

1.2.1.3 As per structure type:

- Deep groove ball bearing (Fig.4.5)
- Self-aligning ball bearing (Fig.4.6)
- Cylindrical roller bearing (Fig.4.7)

Spherical roller bearing (Fig.4.8)

Needle roller bearing (Fig.4.9)

Angular contact ball bearing (Fig.1.4.10)

Taper roller bearing (Fig.4.11)

Thrust ball bearing (Fig.1.4.12)

Thrust roller bearing (Fig.1.4.13)

1.2.1.4 As per the rows of rolling element

- Single row (Fig.1.4.14)
- Double-row (Fig.1.4.15)
- Multi-row (Fig.1.4.16)

1.2.1.5 As per the component separability

- Separable bearing (Fig.1.4.7)
- Non-separable bearing (Fig.1.4.1)

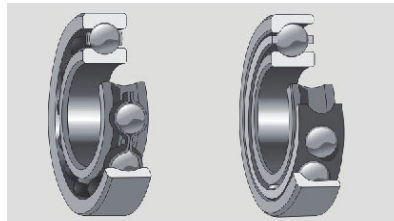

Radial Bearing

Angular Contact Radial Bearing

Fig1. 4. 1

Fig1. 4. 2

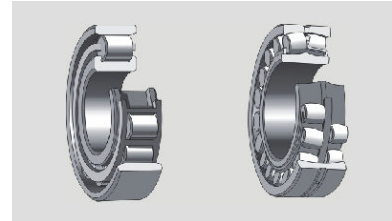

Cylindrical Roller Bearing

Spherical Roller Bearing

Fig1. 4. 7

Fig1. 4. 8

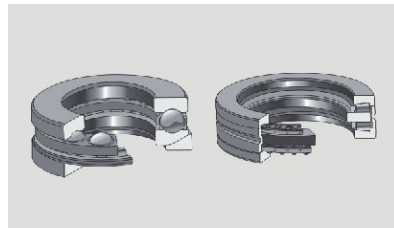

Thrust Bearing

Angular Contact Thrust Bearing

Fig1. 4. 3

Fig1. 4. 4

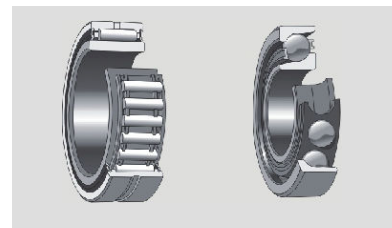

Needle Roller Bearing

Angular Contact Ball Bearing

Fig1. 4. 9

Fig1. 4. 10

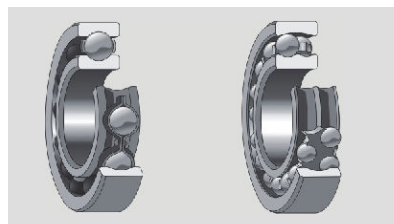

Deep Groove Ball Bearing

Self-aligning Ball Bearing

Fig1. 4. 5

Fig1. 4. 6

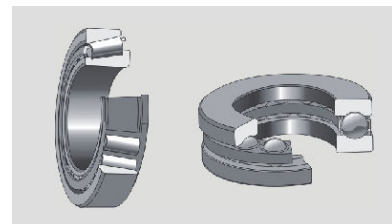

Taper Roller Bearing

Thrust Ball Bearing

Fig1. 4. 11

Fig1.4. 12

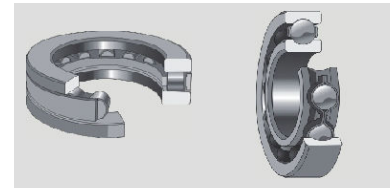

Thrust Roller Bearing
Fig1. 4. 13

Single Row Bearing
Fig1. 4. 14

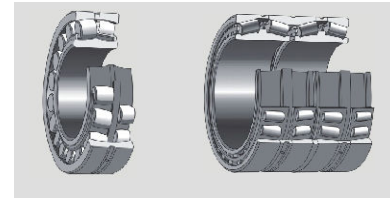

Double-row Bearing
Fig1. 4. 15

Multi-row Bearing
Fig1. 4. 16

Additionally, some bearings with special structures are designed to meet special requirements of certain machinery application, such as railway bearing, hub bearing, rolling mill bearing, ball screw, linear bearing, bearing without a inner ring or outer ring, bearing with shield cover or seals, split outer ring or split inner ring bearing, and integrated split bearing etc.

Basic structures of LYC bearing as Fig.5 showing.

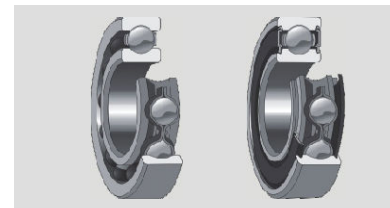

Fig1. 5. 1

Fig1. 5. 2

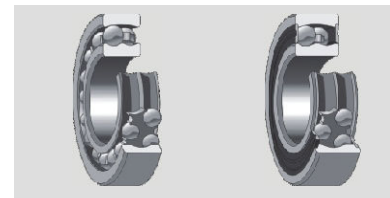

Fig1. 5. 3

Fig1. 5. 4

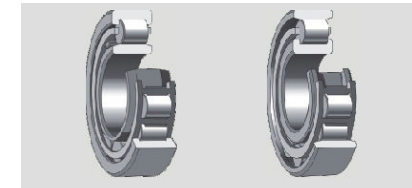

Fig1. 5. 5

Fig1. 5. 6

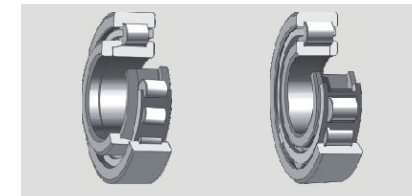

Fig1. 5. 7

Fig1. 5. 8

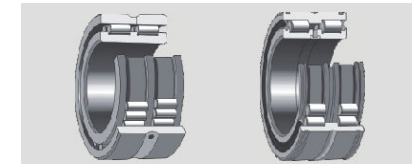

Fig1. 5. 9

Fig1. 5. 10

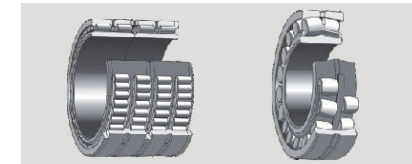

Fig1. 5. 11

Fig1. 5. 12

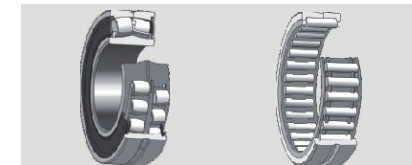

Fig1. 5. 13

Fig1. 5. 14

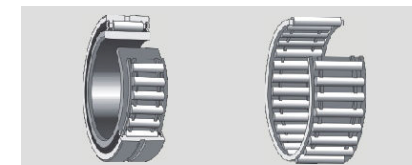

Fig1. 5. 15

Fig1. 5. 16

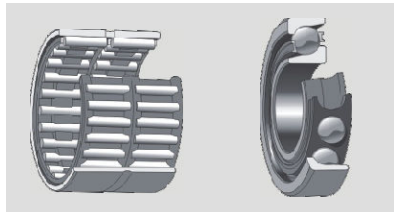

Fig1. 5. 17

Fig1. 5. 18

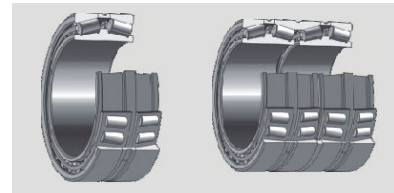

Fig1. 5. 27

Fig1. 5. 28

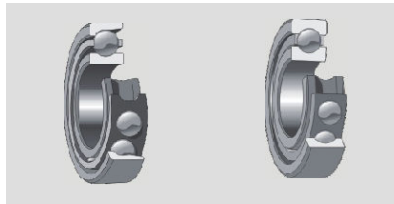

Fig1. 5. 19

Fig1. 5. 20

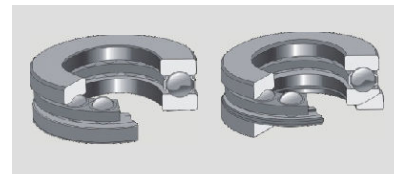

Fig1. 5. 29

Fig1. 5. 30

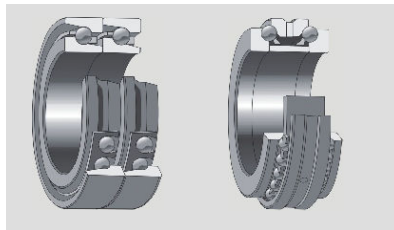

Fig1. 5. 21

Fig1. 5. 22

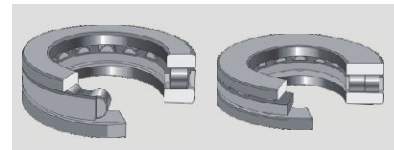

Fig1. 5. 31

Fig1. 5. 32

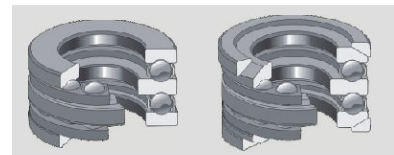

Fig1. 5. 33

Fig1. 5. 34

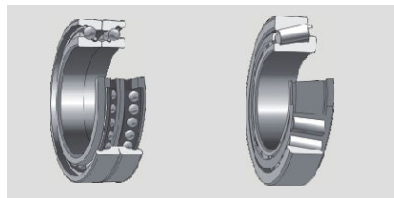

Fig1. 5. 23

Fig1. 5. 24

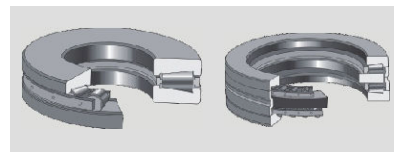

Fig1. 5. 35

Fig1. 5. 36

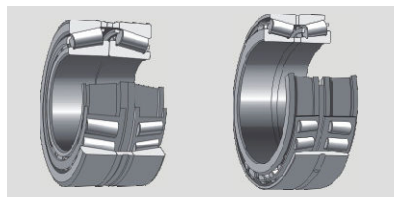

Fig1. 5. 25

Fig1. 5. 26

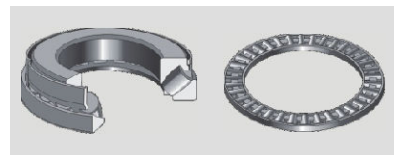

Fig1. 5. 37

Fig1. 5. 38

2. LYC Bearing Designations

2.1 LYC Standard Bearing Designations

LYC's standard bearing designations meet Chinese bearing standard of GB/T272 <Rolling Bearing, Designation Method> and JB/T2974 <Rolling Bearing, Supplementary Rules of Designation Method>

LYC bearing designations consist of the prefix, the bearing basic designation and the suffix.

2.1.1 Basic Designations

The basic designations consist of an identification code of the bearing type, the dimensional series code and the bore diameter code. Identification code of bearing type is listed in Table 2.1.

The dimensional series code is listed in Table 2.2. The bore diameter code is listed in Table 2.3.

Table 2. 1

Code	Bearing Type	Code	Bearing Type
0	Double-row angular contact ball bearings	6	Deep groove ball bearings
1	Self-aligning ball bearings	7	Angular contact ball bearings
2	Spherical roller bearings and spherical roller thrust bearings	8	Cylindrical roller thrust bearings
3	Single row taper roller bearings	9	Tapered roller thrust bearings
4	Double-row deep groove ball bearings	N	Cylindrical roller bearings
35	Double-row taper roller bearings	NN	Double-row or multi-row cylindrical roller bearings
38	Four-row tapered roller bearings	QJ	Four-point contact ball bearings
5	Thrust ball bearings		
56	Angular contact thrust ball bearings		

Table 2. 2

Diameter Series Code	Radial Bearing								Thrust Bearing				
	Width Series Code								Height Series Code				
	8	0	1	2	3	4	5	6	7	9	1	2	
	Dimensional Series Code												
7	-	-	17	-	37	-	-	-	-	-	-	-	-
8	-	08	18	28	38	48	58	68	-	-	-	-	-
9	-	09	19	29	39	49	59	69	-	-	-	-	-
0	-	00	10	20	30	40	50	60	70	90	10	-	-
1	-	01	11	21	31	41	51	61	71	91	11	-	-
2	82	02	12	22	32	42	52	62	72	92	12	22	-
3	83	03	13	23	33	-	-	-	73	93	13	23	-
4	-	04	-	24	-	-	-	-	74	94	14	24	-
5	-	-	-	-	-	-	-	-	-	95	-	-	-

Table 2. 3

Nominal Bore Diameter (mm)	Bore Diameter Code	Example	
0.6 to 10(non-integer)	Directly indicated by the millimeters of nominal bore diameter, separated with dimensional series code by "f"	Deep groove ball bearings 618/2.5 d=2.5mm	
1 to 9(integer)	Directly indicated by the millimeters of nominal bore diameter, for the diameter series 7,8,9 of deep groove ball bearings, bore diameter is separated with dimensional series code by "f"	Deep groove ball bearings 618/5 d=5 mm	
10 to 17	10 12 15 17	00 01 02 03	Deep groove ball bearings 6200 d=10mm
20 to 480 (except 22,28,32)	Indicated by the quotient of dividing bore diameter by 5, if the quotient is single-digit, then add "0" on the left of quotient, e.g. 08	Spherical roller bearings 23208 d=40mm	
Equal to or greater than 500, and 22,28,32	Directly indicated by the millimeters of nominal bore diameter, but separated with dimensional series code by "f"	Spherical roller bearings 230/500 d=500mm	

Example: cylindrical roller bearing N2210
 N- Identification code of the bearing type
 22 - dimensional series code
 10 - bore diameter code

2.1.2 Prefix Code

The most common used prefix codes in LYC's bearing code system are listed and explained as follows:

- L Removable inner or outer ring for a separable bearing
- R Bearing without removable inner or outer ring (only suitable for needle roller bearings of type NA)
- K Roller and cage assembly
- WS Shaft washer of a cylindrical roller thrust bearing
- GS Housing washer of a cylindrical roller thrust bearing
- KOW Thrust bearing without shaft washer
- KIW Thrust bearing without housing washer
- LR Bearing with removable inner ring or outer ring and rolling elements assembly

2.1.3 Suffix Code

• Internal Design

A, B, C, D, E

- 1) Deviating or modified internal design
- 2) Standard type, the design contents can be altered according to different bearing structures, in which:

B indicated nominal contact angle $\alpha = 40^\circ$ for angular contact ball bearings; and it indicates the increased contact angle for taper roller bearings;

C indicated nominal contact angle $\alpha = 15^\circ$ for angular contact ball bearings;

AC Nominal contact angle $\alpha = 25^\circ$ for angular contact ball bearings;

D Split bearings

ZW Needle roller cage assembly, double row

• Codes of Seals, Shields and External Designs

- K Tapered bore taper 1:12 on diameter
- K30 Tapered bore, taper 1:30 on diameter
- 2K Double-row tapered bore bearing, taper 1:12 on diameter
- R Bearing with flanged outer ring
- N Bearing with snap ring groove in outer ring
- N1 Bearing with a locating notch in outer ring
- N2 Bearing with two or more symmetrical locating notch in outer ring

- N4 N+N2, locating notch and snap ring groove are not in the same side
- N6 N+N2, locating notch and snap ring groove are in the same side
- NR Bearing with snap ring groove in outer ring and snap ring
- RS Embedded case rubber seal at one side of the bearing (contact seal)
- 2RS Embedded case rubber seals at both sides of the bearing (contact seal)
- RZ Embedded case rubber seal at one side of the bearing (non-contact seal)
- 2RZ Embedded case rubber seals at both sides of the bearing (non-contact seal)
- Z Bearing with shield at one side
- 2Z Bearing with shields at both sides
- RSZ Bearing with embedded case rubber seal at one side (contact seal) and shield at the other side
- RZZ Bearing with embedded case rubber seal at one side (non-contact seal) and shield at the other side
- ZN Bearing with shield at one side and snap ring groove at the other side in outer ring
- ZNR Bearing with shield at one side and snap ring groove and snap ring at the other side in outer ring
- ZNB Bearing with shield at one side and snap ring groove at the same side in outer ring
- 2ZN Bearing with shields at both sides and snap ring grooves in outer ring
- FS Bearing with felt ring seal at one side
- 2FS Bearing with felt ring seals at both sides
- LS Embedded case rubber seal at one side of the bearing (contact seal, without grooves in bearing rings)
- 2LS Embedded case rubber seals at both sides of the bearing (contact seal, without grooves in bearing rings)
- DC Double-row angular contact ball bearing, double outer rings
- D1 Double-row taper roller bearing, without inner spacer, end face polishing
- DH One-way thrust bearing with two housing washers
- DS One-way thrust bearing with two shaft washers
- P Spherical roller bearing with double split outer rings
- PR Spherical roller bearing with double split outer rings, spacer ring between the two split outer rings
- S 1) Bearing outer ring with spherical surface (except spherical ball bearings)

- 2) Adjustable clearance (needle roller bearings)
- WB Bearing with extended inner ring (double width); WBI single width
- WC Bearing with extended outer ring
- SC Radial bearing in shell
- Z 1) Needle roller combination bearing with shield cover
2) Needle roller and full thrust ball combination bearing in shell (grease lubrication)
- ZH Thrust bearing, housing ring with shield cover
- ZS Thrust bearing, shaft ring with shield cover
- U Thrust ball bearing with spherical washer

• Bearing Components Materials

- /HE Rings, rolling elements and cages, or only rings and rolling elements, made of electroslag refining bearing steel ZGCr15, ZGCr15SiMn
- /HA Rings, rolling elements and cages, or only rings and rolling elements, made of vacuum arc-melted steel
- /HU Rings, rolling elements and cages, or only rings and rolling elements, made of unhardening stainless steel 1Cr18Ni9Ti
- /HV Rings, rolling elements and cages, or only rings and rolling elements, made of hardening stainless steel (/HV-9Cr18; /Hv1-9Cr18Mo)
- /HN Rings and rolling elements, made of heat-resisting bearing steel (/HN-Cr4Mo4V; /HN1-Cr14Mo4; /HN2-Cr15Mo4V; /Hn3-W18Cr4V)
- /HC Rings, rolling elements, or only rings, made of carburized steel (/HC-20Cr2Ni4A; /HC1-20Cr2Mn2MoA; /HC2-15Mn)
- /HP Rings and rolling elements, made of beryllium bronze or other anti-magnetic materials
- /HQ Rings and rolling elements, made of seldom used materials (/HQ-plastic; /Hq1-ceramic)
- /HG Rings, rolling elements, or only rings, made of other bearing steel (/HG-5CrMnMo; /HG1-55SiMoA)
- /CS Bearing components are made of carbon steel
- F Solid cage made of steel, nodular cast iron or power metallurgy (F1-carbon steel; F2-graphite steel; F3-nodular cast iron; F4V power metallurgy)

- Q Bronze solid cage (Q1-ferro-aluminium manganese bronze; Q2-ferro-silicon zinc bronze; Q3-nichrome silicon bronze; Q4-aluminium bronze)
- M Brass solid cage
- L Light alloy solid cage (L1-LY11CZ; L2-LY12CZ)
- T Phenolic pressure piping solid cage
- TH Glass-fiber-reinforced phenols resin cage (basket type)
- TN Molded cage with engineering plastic (TN1-nylon; TN2-polysulfone; TN3-polyimide; TN4-polycarbonate; Tn5-polyformaldehyde)
- J Pressed steel plate cage
- Y Pressed brass plate cage
- SZ Cage is made of spring steel wire or spring plate
- ZA Zinc-aluminum cage
- V Full complement bearing(without cage)

• Tolerance and Clearance

- /P0 Tolerance class conforms to standard group 0, not shown in the bearing code
- /P6 Tolerance class conforms to standard group 6
- /P6x Tolerance class conforms to standard group 6x
- /P5 Tolerance class conforms to standard group 5
- /P4 Tolerance class conforms to standard group 4
- /P2 Tolerance class conforms to standard group 2
- /SP Dimensional precision equal to class P5, rotation precision equal to class P4
- /UP Dimensional precision equal to class P4, rotation precision is above class P4
- /UP Tolerance class conforms to standard P4, rotation precision is above class P4
- /CM Internal clearance of deep groove ball bearing for electric motor
- /C0 Internal clearance conforms to standard group 0, not shown in the bearing code
- /C1 Internal clearance conforms to standard group 1
- /C2 Internal clearance conforms to standard group 2
- /C3 Internal clearance conforms to standard group 3
- /C4 Internal clearance conforms to standard group 4
- /C5 Internal clearance conforms to standard group 5
- /CM Internal clearance of deep groove ball bearing for electric motor

/C9 Bearing internal clearance differs from the present standard

When tolerance and clearance need to be indicated simultaneously, it can be simply shown as /P3, P43 etc, in which /P3 indicates bearing tolerance class P3 and radial clearance of basic group (group 0), /P43 means bearing tolerance class P4 and radial clearance of group 3.

• **Codes of Dimensional Series**

- X1 Outer diameter non-standard
- X2 Width (assembling height) non-standard
- X3 Outer diameter and width (assembling height) non-standard (inner diameter standard)

• **Codes of Bearing Configuration**

- /DB Back-to-back arrangement
- /DF Face-to-face arrangement
- /DT Tandem arrangement

• **Other Codes of Bearing Features**

- /Z Limited values of the vibration acceleration level, I_{re} additional figures indicate the different limited values, as Z1, Z2, Z3
- /V Limited values of the vibration speed level, the additional figures express the different values, as V1, V2, V3
- /SO The bearing ring are high-tempered through heat treatment, and the operating high temperature is up to 150 °C
- /SI The bearing rings are high-tempered through heat treatment, and the operating high temperature is up to 200 °C
- /S2 The bearing ring are high-tempered through heat treatment, and the operating high temperature is up to 250 °C
- /S3 The bearing ring are high-tempered through heat treatment, and the operating high temperature is up to 300 °C
- /S4 The bearing ring are high-tempered through heat treatment, and the operating high temperature is up to 350 °C
- /W20 The bearing with three lubrication holes in outer ring
- /W26 The bearing with six lubrication holes in outer ring
- /W33 The bearing with a lubrication groove and three lubrication holes in outer ring
- /W33X The bearing with three lubrication holes and six lubrication holes in outer ring
- /AS The bearing with lubrication holes in outer ring, the additional figure shows the numbers of oil hole (used for needle roller bearings)
- /IS The bearing with lubrication holes in inner ring, the additional figure shows the

numbers of oil hole (used for needle roller bearings)

When R is added behind AS, IS, they respectively express the inner ring or outer ring with a lubrication hole and groove

- /HT The bearing is filled with special grease for high temperature, grease quantities which differ from the standard filling are identified by an additional letter:
A-grease quantity is less than standard filling
B-grease quantity is more than standard filling
C-full quantity of grease
- /LT Bearing with the special grease for lower temperature
- /MT Bearing with die special grease for medium temperature
- /LTH Bearing with the special grease for lower or high temperature
- /LHT Bearing with the grease for lower or higher temperature, the additional letter is the same meaning as HT
- /Y Combinations of the letter Y with another letter or figure can identify differences from the standard design which are not concluded by other established suffixes
- /YA Modification of structures (comprehensive expression)
- /YB Alteration of specifications (comprehensive Expression)

Note: If suffix Y with another letter or additional figure are presented in bearing designations, the product drawings or the supplementary specifications must be looked up from the LYC design department to identify more information.

2.2 LYC Special Bearing Code

LYC's standard bearing designations should meet most bearings with standard structure and boundary dimension, but, it is still difficult to attain some individual requirement of special structure or boundary dimension due to the diversity of bearing structures and extensive applications. For this reason, LYC make up special bearing codes to meet the requirement in this part of the bearings. LYC special bearing code consists of our designation "LY", "-" and "serial-number of bearing type", in which the first letter (or Figure) in the serial number of bearing type symbolizes the code of bearing type, shown in Table 2.1.

The last three Figures constitute the serial number of the bearing. Serial number indicates the sequences of bearing design and manufacture.

- e.g. 1:LY-6008
- LY-(LYC company code)
- 6- Bearing series number (deep groove ball bearing)
- 008- The eighth special bearing designed and produced by LYC in deep groove ball bearing e.g.2:LY-N1012
- LY-(LYC company code)
- N- Bearing series number (cylindrical roller bearing)
- 012-The twelfth special bearing designed and produced by LYC in cylindrical roller bearing.

3. Selection of Bearing Type

It is extremely important to select the correct bearing for the duty that is expected of it, eg: life expectancy and service intervals. You will see within this catalog there are many complex bearing structures that can be applied to an array of various applications. The applications and performance of various bearings are explained; these explanations are only a generalization. For absolute assurance of the correct bearing selection customers should contact the LYC Technical Department for their expertise in bearing selection. The LYC technical staff will request a detailed amount of information regarding the application before they will make a recommendation. Based on many practical experiences of bearing application, theory analysis and research, LYC's technical department suggests: when selecting bearing types or structures, the customer should make comprehensive analysis according to the following aspects, weigh up the pros and cons, choose the bearing type suited to your application.

- Available space
- Bearing load
- Aligning capacity
- Turning speed
- Turning precision
- Stiffness
- Noise and vibration
- Axial displacement
- Frictional moment
- Mounting and dismounting

Besides, additional factors like bearing load capacity, internal clearance, life rating, reliability, preload, lubrication, seal as well as source cost and delivery on-time should be taken into account.

3.1 Available Space

Internal dimension is one of the main principles for bearing selection. During the machinery design,

journal dimension is one of the first confirmed parameters through the methods of theoretical calculation or analogy. Selection of the bearing is always according to the diameter of shaft. Ball bearing or thrust ball bearing can be selected for small diameter shaft, which, usually apply for low load status. Cylindrical bearing, taper roller bearing or spherical roller bearing can be selected for a heavy load or safety consideration.

Normally, the bearing's available space in machinery can be limited. If radial space is limited, the bearing with small radial cross section should be selected (Fig 3.1) such as the kinds of bearings with a diameter series 7, 8, 9. If axial space is limited, the bearing with small axial cross section should be selected (Fig 3.2) such as all kinds of bearings with width series 8, 0, 7, 9.

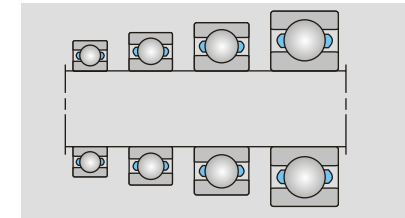

Fig3. 1

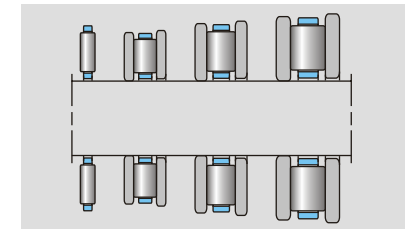

Fig3. 2

3.2 Bearing Load

3.2.1 Load Strength

Load strength on the bearing is very important for bearing selection. Generally speaking, roller bearings can carry heavier loads than ball bearings when with the same boundary dimension, similarly cageless rolling bearings carry heavier loads than bearings with cages. Therefore, ball bearings are fit for low and medium loads, and roller bearings are fit for heavy loads.

3.2.2 Load Direction

When the bearings carry pure radial load, radial bearings should be selected, such as deep groove

ball bearing, cylindrical roller bearing and needle roller bearing etc., shown as Fig 3.3a.

When the bearing carries pure axial load, thrust bearings should be selected, such as thrust ball bearing, cylindrical roller thrust bearing or needle roller thrust bearing etc., shown as Fig 3.3b.

When bearings carry radial and axial (combined loads), angular contact bearings are generally selected. If the radial load is larger and axial load is smaller, then the angular contact radial bearing should be selected, such as angular contact ball bearing. If the radial load is smaller than axial load in the combined load, then an angular contact thrust bearing should be selected, such as the angular contact thrust ball bearing, shown as Fig 3.3c.

When the load acts eccentrically on the bearing, tilting moments will arise. If moment load is not large, the single row angular contact ball bearings in pair arranged face-to-face or back-to-back as well as single-row taper roller bearings would be more suitable (Fig 3.3d). But, for some larger machinery or an application carrying a large tilting moment, such as crane, mineral machinery,

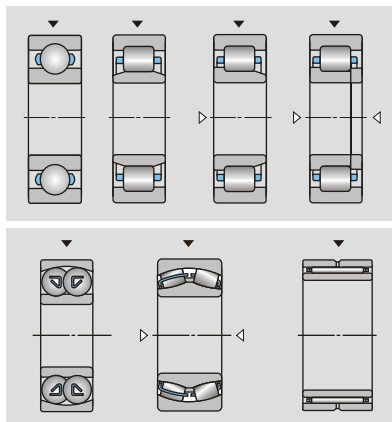

Fig3. 3a

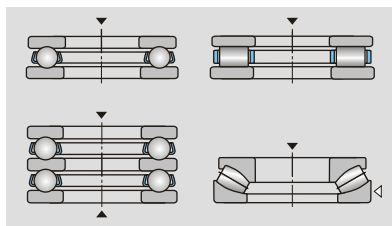

Fig3. 3b

antenna base for radar, rocket launcher etc., then a slewing bearings would be more suitable. Information about slewing bearing can be found in the catalog of <LYC Slewing Bearings>.

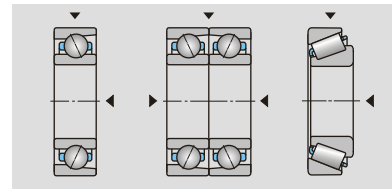

Fig3. 3c

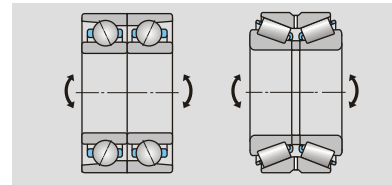

Fig3. 3d

3.3 Aligning Capacity

In normal applications, the shaft deflection would occur due to load, or mounting errors, or components deviation in production, that will make the inner ring and outer ring slant (Fig 3.4) and cause uneven loads on the bearing raceway and generate excessive loads. Severe cases will cause stress concentration, and result in early failure. Therefore, aligning capacity should be considered when selecting bearings.

The bearing deflection within the allowed angle error will not influence the normal working of the bearing; allowed angle error for all kinds of bearing are listed in the Table 3.1.

When selecting bearings, self-aligning ball bearing, spherical roller bearing or thrust spherical roller bearing, pillow block bearing could be selected for the larger deflection situation. The allowed angle errors for self-aligning ball bearing and spherical roller bearing are shown in Table 3.2.

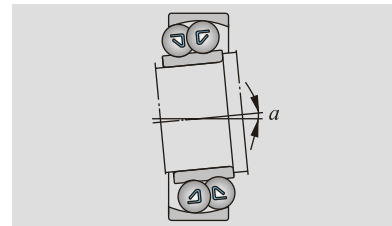

Fig3. 4

Table3. 1

Bearing Type	Angle error allowed
Deep groove ball bearing (clearance group 0)	8'
Deep groove ball bearing (clearance group 3)	12'
Deep groove ball bearing (clearance group 4)	16'
Cylindrical roller bearing (N, NU series)	4'
Cylindrical roller bearing (Other series)	2'
Single row taper roller bearing	2'

Table3. 2

Self-aligning ball bearing		Spherical roller bearing	
Dimension series	Angle error allowed	Dimension series	Angle error allowed
12	2.5°	213	1°
13	3°	222	1.5°
14	3°	223	2°
22	2.5°	230	1.5°
23	3°	231	1.5°
		232	2.5°
		239	1.5°
		240	2°
		241	2.5°

3.4 Turning Speed

The speed will have little influence on the bearing selection when working under the medium and low speed (less than 0.5 times of limiting speed). However, turning speed must be considered in the case of the higher speed, because the inertia force from rolling elements and cages will have large effect on the load distribution, temperature, and vibration etc. under high speed.

The highest speed of bearing is limited, which is the so-called "limiting speed". "Limiting speed" depends on the working temperature of the bearing, which, depends on the various factors such as structure, material, dimension, precision, clearance, load, lubrication, heat dispersion of the bearing, and cage structure, material, and guiding method etc.

Generally speaking, friction coefficient of ball bearing is lower than that of roller bearing, so the limiting speed of ball bearings are higher than that of roller bearings. The speed of thrust bearing is lower than a radial bearing due to the restriction of the structure. When deep groove ball bearings and cylindrical roller bearings carry pure radial load, they are suitable for high speed applications. While the single-row angular contact ball bearing carry combined load, it can operate well at high speed.

Additionally, if customers require bearings with higher speed than the limiting speed in the

dimension list of LYC catalogue, then please consult the technical department of LYC.

3.5 Running Accuracy

Running accuracy of the bearing is not only related to the parameters of structure, producing precision, clearance and stiffness of bearings, but also related to the supporting structure, material, stiffness, manufacture precision and mounting precision. Therefore, the selection of bearing precision should be considered from both aspects of bearing manufacture and application.

In view of bearing manufacture, all kinds of bearings with normal precision could meet the requirements of most bearing applications. When part of the machinery require strict running accuracy, such as machine tool spindles or high speed shaft applications and the condition of high maintenance and with high reliability, the precision bearings must be selected to satisfy this requirement.

LYC technical department reminds customers: when selecting precision bearings, the manufacturing and mounting precision and rigidity of matched shaft and bearing housing bore should be improved, otherwise, precision bearing would not play its function.

The precision tolerances of all kinds of LYC's bearings are shown in the part of 'General Data' in this catalogue.

3.6 Stiffness

Bearing stiffness refers to the elastic deformation generated from the contacting position of the bearing rings and rolling elements, its deformation degree is also called stiffness. Normally, the elastic deformation of bearing is very small, therefore, it could be ignored in most situations. However, the elastic deformation is of significance in some applications, e.g. machine tool spindle bearing, the requirement of bearing stiffness should have detailed investigation.

Generally, because of the contact conditions between rolling elements and raceways are linear in theory, the roller bearing such as cylindrical roller bearings and taper roller bearings have greater stiffness than theoretical point contact ball bearings.

The stiffness can be enhanced by preloading, but, the preloading amount should be controlled.

Suitable preload can improve bearing precision and fatigue life. However, if preloading amount exceeds an optimum value, then the bearing stiffness has increased little; conversely, it will

have destroyed influence on the bearing operation, such as bearing friction and abrasion increasing, the temperature. The stiffness of the angular contact bearing can be realized by different bearing configuration.

3.7 Noise and Vibration

Bearings can make sounds during their operation. This is the result of vibration, sounds can be classified into acceptable sounds and noise. Acceptable sounds are generated by the rolling of rolling elements on the raceway and are smooth and continuous. However, noise is resulted from a number of abnormal conditions, such as bad component contacts or pore lubrication, foreign matter invasion, damage of bearing working surfaces, dimension error etc., these sounds have characteristics of discontinuity, or regularity, or vibration.

In some applications, such as household appliances, medical appliance, office equipment etc., noise and vibration must be strictly controlled. However, the sounds and vibration of the bearings used for general application are much lower than that of the matched parts, so it is not necessary to control.

Then testing for bearings noise needs to be evaluated. Noise control is usually ensured by testing the vibration value of bearings. LYC can supply all groups of low-noise bearings.

3.8 Axial Displacement

The turning shaft adopts double support in machinery. Two supports are used for confining radial displacement, while there are three methods to restrict the axial displacement, i.e. support with both ends fixed, one end fixed but the other free and both ends freely.

Bearings used in the fixed end applications are called fixed end bearing. These require to be in an axial location (except where the axial displacement results from the clearance). Bearings which carry combined load or supply axial orientation together with another bearing such as deep groove ball bearing, angular contact ball bearing, self-aligning (spherical roller) bearing etc. is best suited to be a fixed end bearing. Bearings used in free end are called wandering end bearing, which, can allow the shaft to displace axially. For example, as the thermal expansion of shaft, the length of shaft will become longer, but, the bearing will not carry exceeding load or jam for this reason through a certain axial displacement. Needle roller bearing or N, NU series of cylindrical

best choice. The NJ series of cylindrical roller bearing can also be used as wandering end bearing. When a shaft needs a larger axial displacement, the clearance fit could be taken into consideration, but, the fit surface should be appropriately lubricated.

If a deep groove ball bearing, self-aligning (spherical roller) bearing must be adopted as wandering end bearing, clearance fit could be considered, but, the fit surface should be appropriately lubricated.

3.9 Frictional Moment

Friction happens when the bearing running. The frictional force depends on several factors, such as the bearing type, dimension, load, running speed, characteristics of lubricants and lubrication amount.

The summation of all kinds of frictions within bearing could be measured by friction moment In general, frictional resistance of ball bearings is smaller than that of roller bearings. When bearings carry pure radial load, the friction moment of thrust ball bearings is smaller. When bearings carry pure axial load, the friction moment of thrust ball bearings is smaller also. Angular contact bearings, whose load angle is almost the same with contact angle, have the smallest friction moment under the combined load. The relationship of load angle B and contact angle α is shown in Fig. 3.5.

Deep groove ball bearings and cylindrical roller bearings should be a priority selection, when customers need low friction moment bearings. If sealed bearings need to be used in low friction moment, contact sealed bearings should not be selected. All kinds of sealed bearings can be selected in the case of low frictional moment, but It is necessary to notice that bearings with rubbing seal should be avoid.

The feature and volume of lubricant has a certain influence on friction moment, it is suggested to adopt low viscosity (or low consistence) lubricant hi the low friction moment application. Drop lubrication, oil jet lubrication and oil mist lubrication are recommended when using oil lubrication.

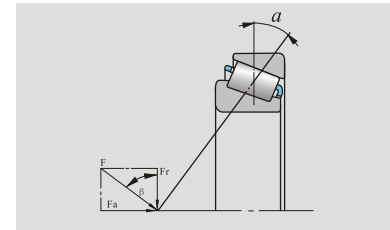

Fig3. 5

3.10 Mounting and Dismounting

• Cylindrical Bore

Separable bearings with cylindrical bore, such as angular contact ball bearings, cylindrical roller bearings, needle roller bearings, taper roller bearing and thrust bearings etc., can be mounted













on the shaft or into the housing bore independently. If mounting and dismounting are required often hi bearing applications, the bearings mentioned above should be priority selection.

• Tapered Bore

Bearings with tapered bore can be mounted directly on the journal and can be easily mounted on a cylindrical shaft with appropriate adapter or withdrawal sleeve. Self-aligning ball bearings, spherical roller bearings or double row cylindrical roller bearings with tapered bore should be selected.

Bearings with tapered bore also have an effect of adjusting the radial clearance. General selection of bearing type is shown hi Table 3.3.

Table 3. 3

Characteristic	Bearing Type			
	Deep Groove Ball Bearings	Angular Contact Ball Bearings	Paired Angular Contact Ball Bearings	Self-aligning Ball Bearings
Load capacity				
Radial load				
Axial load				
Speed performance	△△△△ ¹⁾	△△△△	△△△	△△
Running accuracy	△△△	△△△	△△△	
Noise and vibration	△△△△	△△△	△	
Frictional moment	△△△△	△△△	△△	△
Stiffness			△△	
Vibration and impact resistance				▲ ¹⁾
Deflection allowed for inner ring and outer ring	△			△△△
Aligning performance				☆ ²⁾
Separability of inner ring and outer ring				
Tapered bore of inner ring				☆
Axial fixation	◎ ³⁾	○ ³⁾	◎DB、DF Assembled	◎
Axial movement	○		○DB Assembled	○





Note: 1)The more the symbols△are , the better the features are; symbol▲means unavailable.





2) Symbol☆means applicable.

3) Symbol◎ : could make axial bidirectional movement;

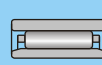
Symbol○ : could only move along one direction (axial movement) .

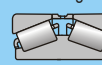
Add table 3. 3

Cylindrical Roller Bearings	Single Flanged Cylindrical Roller Bearings	Double Flanged Cylindrical Roller Bearings	Double-row Cylindrical Roller Bearings	Needle Roller Bearings
				
↑	↙	↕	↑	↑
△△△△	△△△	△△△	△△△	△△△
△△△	△△	△	△△△	
△	△	△	△	△
△				
△△	△△	△△	△△△	△△
△△	△△	△△	△△	△△
△				
☆	☆	☆	☆	☆
			☆	
	○	◎		
◎			◎	◎

Tapered Roller Bearing	Two Row, Four Row Tapered Roller Bearings	Spherical Roller Bearings	Thrust Ball Bearings	Thrust Roller Bearings
				
↙	↕	↕	←	←
△△△	△△	△△	△	△
△△△	△		△	
△△	△△△△	△△△		△△△
△△	△△△	△△△		△△△
△		△△△	▲	▲
		☆		
☆	☆		☆	☆
		☆		
○	◎	◎	○	○
	○	○		

4. Selection of Bearing Size

Selection of bearing sizes is confirmed according to the requirement of bearing load, life and reliability. The bearing basic load rating could be used for calculating the required bearing size when selecting bearing size. For rotating bearing, basic dynamic load rating could be used for calculation. Low speed or static bearing can be calculated according to basic static load rating. Beside, the basic load rating is an important parameter for calculation of bearing life. Dynamic (static) load rating of each size could be found in the dimension table of this catalogue.

4.1 General Definition

4.1.1 Life and Reliability

The life of a single roller bearing means revolutions of one bearing ring (or washer) toward another ring (or washer) before the first fatigue expanding indication appeared on one bearing (or washer) or material of rolling elements. The bearing reliability refers to the percentages of the bearings, which is up to or exceeding specified life, in a similar group of rolling bearings running under the same condition.

4.1.2 Basic Rating Life

Basic rating life is the life of an individual rolling bearing or a similar group of rolling bearings, which is related with 90% reliability, common used material and processing quality, and normal operating condition. Usually, bearing life refers to the basic rating life of rolling bearings without special instruction.

4.1.3 Basic Dynamic Load Rating

• Basic Dynamic Radial Load Rating

Basic dynamic radial load rating is the constant radial load theoretically carried by a piece of rolling bearing. The basic load rating of bearing is one million revolutions under this load. For single row angular contact bearings, the load refers to the radial component of the load resulted in the pure radial displacement between the bearing rings.

• Basic Dynamic Axial Load Rating

Basic dynamic axial load rating is the constant central axial load theoretically carried by a piece of rolling bearing. The basic load rating of bearing is one million revolutions under this load.

4.1.4 Basic Static Load Rating

• Static Load

Static load means the load acting on the bearing when the relative speed of the bearing rings is zero (or extremely low)

• Basic Static Radial Load Rating

Basic static radial load rating means a central radial static load equivalent to the following computed stress generated on the contact centre of the rolling elements and raceway under the maximum load.

Self-aligning ball bearings	4600MPa
Other types of radial bearings	4200MPa
Radial roller bearings	4000MPa

For single row angular contact bearings, the load refers to the radial component of the load resulting in the pure radial displacement between the bearing rings.

• Basic Static Axial Load Rating

Basic static axial load rating means a central axial static load equivalent to the following computed stress generated on the contact centre of the rolling elements and raceway under the maximum load.

Thrust ball bearings	4200MPa
Thrust roller bearings	4000MPa

4.1.5 Equivalent Load

• Equivalent Dynamic Load

Radial (axial) equivalent dynamic load is a constant radial (central axial) load, under which rolling bearings have the same life as that under the actual load.

• Equivalent Static Load

Radial (axial) equivalent static load means radial (central axial) static load, which is the same with the contact stress under the actual load, generated from the contact centre of the rolling elements and raceway under the maximum load.

4.1.6 Bearing Life

Practice proves that rolling bearings have the characteristics of randomness and discreteness. Bearings with the absolutely same dimensions and structures under the exact same working conditions may still have different lives. Therefore, the concept of bearing life must be clearly realized when selecting bearing size.

The basic dynamic load rating calculated by LYC is based on the large enough quantity of bearings with absolutely the same structure and dimension. Among them, 90% life reliability could be reached or exceeded.

In practice, there are many expressions for bearing life. Working life indicates the bearing life before its failure caused by malfunction under the normal working conditions. These breakdowns are component burn, abrasion, components fracture, corrosion, and dimension distortion etc. Although these breakdowns caused by similar reasons lead to bearing failure, these failure modes are

different. Therefore, this should not be mixed with bearing life. The failure mode of bearing life is material fatigue, the bearing life refers to the fatigue life of bearing.

Notice that in view of the extensive application and diverse structures of bearings, there is no effective method at present to exactly predict the specific value of bearing life for an individual bearing, except reinforcing the testing during the application. Bearing life is established on the basis of mathematical statistics towards the bearings with the same structure, dimension and certain reliability (e.g.90%). In other words, bearing life means 90% (reliability) of a great many bearings that could reach the basic dynamic load rating in their applications. So bearing life is not for an individual bearing.

In practice, for the most safety estimating method of bearing life is analogy, i.e. making the optimum choice after analogy with applied and a similar situation according to the actual application of the bearing.

4.2 Selecting Bearing Size According to Basic Static Load Rating

Bearing size should be selected according to the basic static load rating C_0 , where a bearing is working under the following conditions:

- Bearing is static under continuous or intermittent (impact) load
- Bearing only has slowly repeated swaying or adjustable movement under load
- Bearing is running at slow speed under load, normally $n < 10$ r/min
- Bearing is rotating, but it carries larger impact load except the normal working load

From the above mentioned conditions, bearing life does not depend on the fatigue life of material at this time, but, the permanent plastic deformation degree of the raceway and rolling elements caused by the load. The load, which is acting on static, slowly running or slowly repeated swaying bearing, may result in flattening of some part of rolling elements or dents on the raceway. The permanent plastic deformation on the working surface of components may also cause a quality problem such as vibration, noise, precision lose, increased friction etc.

When selecting bearing size, if there is any one of the following situations, we not only need to calculate the bearing life, but also to check basic static load rating C_0 :

- High reliability
- Low noise or low vibration
- Larger impact or vibrational load

4.2.1 Calculation of Equivalent Static Load

The equivalent static load can be calculated separately by the following formulas, and finally the larger value should be adapted.

$$P_0 = X_0 Fr + Y_0 Fa$$

$$P_0 = Fr$$

where

P_0 – Equivalent static load, N
 Fa – Axial load, N
 Fr – Radial load, N
 X_0 – Radial load coefficient
 Y_0 – Axial load coefficient

The specific values of X_0 , Y_0 are listed in the bearing dimension table in this catalogue.

4.2.2 Selecting Bearing Size According to Basic Static Load Rating

Selecting bearing size according to basic static load rating, calculating as per the following formula:

$$C_0 \geq S_0 P_0$$

where

C_0 – Basic static load rating, N
 P_0 – Equivalent static load, N
 S_0 – Safety factor (Table 4.1)

When selecting bearing size according to basic static load rating, we should also note that the stiffness of the parts matched with bearings should be considered. S_0 should be a larger value if stiffness is weaker, conversely, a smaller value.

Table 4.1

Applications	$S_0 (\geq)$
High requirement for rotating accuracy and stability, or carrying impact load	1.2~2.5
Normal Application	0.8~1.2
Low requirement for rotating accuracy and stability, or not carrying impact load	0.5~0.8

Example:

Bearing 6206E is selected for a machine in normal application with low speed. The equivalent static load on the bearing $P_0=6000N$, try to check the safety factor.

After checking the bearing size table in this catalogue, bearing 6206E: $C_0=11200N$.

$$S_0 = \frac{C_0}{P_0} = \frac{11200}{6000} = 1.87$$

According to Table 4.1, bearings for normal application: $S_0=0.8-1.2$, the calculated value of S_0 is larger than specified value, so as to meet the requirement.

4.3 Selecting Bearing Size According to Basic Dynamic Load Rating

4.3.1 Calculation of Equivalent Dynamic Load

The load carried by bearings is derived from the weight and acting force of the supported objects, such as rotating shaft, all kinds of components mounted on the rotating shaft, driving force, and the additional load generated by the rotation of all types of components. Some loads can be gained from the theoretical calculation, some loads are difficult to calculate, such as the additional load generated by the rotation of components, impact load resulted from vibration. Therefore, in view of reliability, are usually add load coefficient on the basis of theoretical calculation of the main loads, load coefficient f_p is shown in Table 4.2.

Table 4.2

Properties of Bearing Load	f_p	Applications
Without or with slight impact	1.0-1.2	Electric motors, steam turbines, ventilator, pumps
Medium impact	1.2-1.8	Vehicles, machine tools, driving device, crane, metallurgical equipment, internal combustion engines, gearbox
Heavy impact	1.8-3.0	Crushers, rolling mills, oil rigs, vibrating screens

For the bearing supported by pure radial or axial loads, the formula of equivalent dynamic load is:

$$P = f_p \cdot F_a$$

$$P = f_p \cdot F_r$$

But, in the actual applications, the bearing has little chance to carry pure radial load or pure axial load, in many cases, bearing simultaneously carries combined forces of radial and axial loads. Therefore, the actual loads must be converted into equivalent dynamic loads when calculating the bearing life, the specific derivation method is:

$$P = XFr + YFa$$

where

P – Equivalent dynamic load, N

F_r – Radial load, N

F_a – Axial load, N

X – Radial factor

Y – Axial factor

The specific values of coefficient X and Y are listed in the bearing dimension tables of this catalogue.

When considering the working conditions of vibration or impact:

$$P = f_p (XFr + YFa)$$

4.3.2 Equivalent Dynamic Load Rating for Face to Face Mounted Angular Contact Bearing

When carrying radial load, interior of angular contact bearing will generate axial force due to its structure. When mounting the angular contact bearings in pairs, in the sight of the balance of axial force series, toward another bearing, the internal axial force of one bearing is part of imposed axial load, so the influence of internal axial force should be considered when calculating the equivalent dynamic load of this type of bearings. Internal axial force is related to radial load of bearing and contact angle, approximate calculation formula of internal axial force is:

$$S = 1.25Fr \cdot \tan \alpha$$

where

S – Internal axial force, N

α – Actual contact angle

F_r – Radial load, N

Under different mounting situation, the calculation formula for axial loads F_{aI} , F_{aII} of bearing I, II is shown in the Table 4.3.

4.3.3 Mean Equivalent Dynamic Load

In many applications, bearing loads are not always under constant state, and will have some changes. So mean equivalent dynamic load should be introduced into the equation.

• Fluctuating Loads and Speeds

If the bearing is under the effect of P_1, P_2, P_3, \dots , the corresponding speed is n_1, n_2, n_3, \dots , and the rotating time is t_1, t_2, t_3, \dots (Fig. 4.1), and the mean equivalent dynamic load is:

$$P_m = \left(\frac{P_1^\epsilon n_1 t_1 + P_2^\epsilon n_2 t_2 + P_3^\epsilon n_3 t_3 + \dots}{n_m} \right)^{\frac{1}{\epsilon}}$$

where

n_m – Average speed, $n_m = n_1 + n_2 + n_3 + \dots$

ϵ – Life index, ball bearing $\epsilon = 3$, roller bearing $\epsilon = 10/3$

Table 4.3

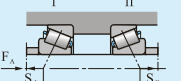
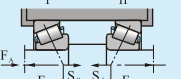
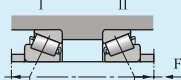
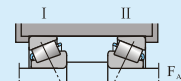
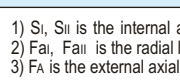
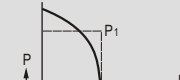
Mount Sketch	Load Condition	F_{aI}	F_{aII}
	$S_I \leq S_{II}$ $F_a \geq 0$	$S_{II} + F_a$ S_I	S_{II} $S_I - F_a$
	$S_I > S_{II}$ $F_a \geq S_I - S_{II}$		
	$S_I > S_{II}$ $F_a < S_I - S_{II}$	S_I $S_{II} - F_a$	$S_I + F_a$ S_{II}
	$S_I \geq S_{II}$ $F_a \geq 0$		
	$S_I < S_{II}$ $F_a \geq S_{II} - S_I$		
	$S_I < S_{II}$ $F_a < S_{II} - S_I$		

Note: 1) S_I, S_{II} is the internal axial force for bearing I and bearing II
2) F_{aI}, F_{aII} is the radial load carried by bearing I and bearing II.
3) F_a is the external axial load acted on the shaft series.

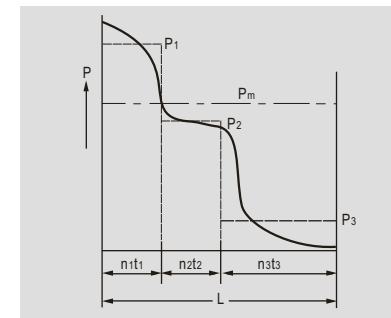

Fig. 4.1

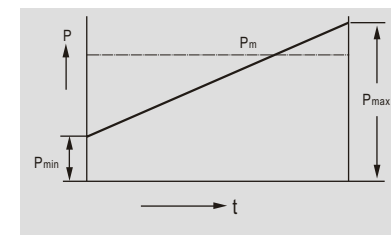

Fig. 4.2

• Constant Speed, Load with Approximating Line Shape Variation

When bearing speed and load direction are constant, the loads only fluctuate between P_{min} and P_{max} similar to line shape (Fig. 4.2), the mean equivalent dynamic load is:

$$P_m = \frac{P_{min} + 2P_{max}}{3}$$

• Rotating Load

As illustrated in Fig.4.3, if the bearings carry combined actions of F_1 and F_2 , the load on the bearing consists of load F_1 which is constant in magnitude and direction (e.g. the weight of a rotor), and a rotating constant load F_2 (e.g. a centrifugal force caused by an unbalanced load), the mean load can be obtained from:

$$F_m = f_m (F_1 + F_2)$$

Values for the factor f_m can be obtained from fig.4.4.

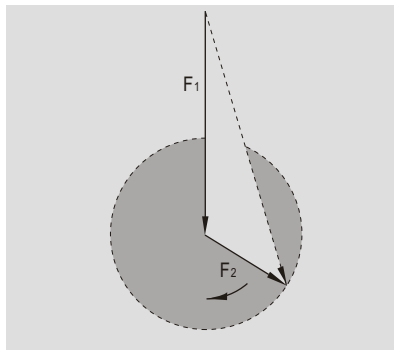

Fig4. 3

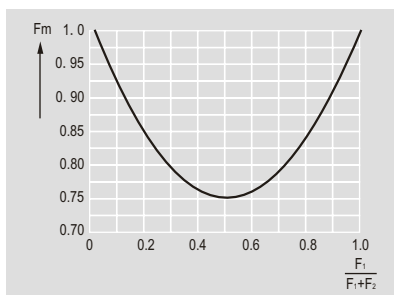

Fig4. 4

4.3.4 Modified Coefficient of Basic Dynamic Load Rating

In actual applications, the working temperature of normal bearings could not be over 120°C in applications, where bearings operate over this temperature, they should adopt the material with special heat treatment or special material. During high temperature, the hardness of bearing surface will be reduced, consequently the basic dynamic load rating is influenced accordingly. So the temperature factor f_T should be brought into this equation for modifying basic dynamic load rating. Basic dynamic load rating after modification:

$$C_T = f_T \cdot C$$

Where

C_T – Basic dynamic load rating when the operating temperature is $T^\circ\text{C}$, N

f_T – Temperature factor, see (Table 4.4)

Table 4. 4

Operating Temperature (°C)	<120	125	150	175	200	225	250	300
f_T	1.00	0.95	0.90	0.85	0.80	0.75	0.70	0.60

When the parts surface hardness changes due to some reason, the hardness factor f_H should be brought in, and basic dynamic load rating after modification is:

$$C_H = f_H \cdot C$$

Where

C_H – Basic dynamic load rating after the hardness factor modified, N

f_H – Hardness factor

$$f_H = \left(\frac{\text{HRC}}{58} \right)^{8.6}$$

Where

HRC is the hardness value from the actual measurement of the bearing.

4.3.5 Selecting Bearing Size According to Basic Dynamic Load Rating

According to the life formula in GB/T6391 <Rolling bearing dynamic load rating and rating life>, for the simplified calculation, take 500 hours as the nominal life and then derive the speed factor f_n and life factor f_L

$$f_n = \left(\frac{33 \frac{1}{3}}{n} \right)^{1/\epsilon}$$

$$f_L = \left(\frac{L_{10h}}{500} \right)^{1/\epsilon}$$

So basic dynamic load rating could be calculated according to the following formula:

$$C = \frac{f_n}{f_L} P$$

Based on this rewritten basic dynamic load rating formula, when the bearing operation speed n and anticipated service life L_{10} are assured, corresponding factor value f_n and f_L can be obtained by searching in the Table 4.5 and 4.6 according to n , L_{10} . Then introduce the factor value f_n and f_L into the equation, the basic dynamic load rating value of the candidate bearing can be assured conveniently and accurately, then the bearing size can be selected according to basic dynamic load rating, which can be searched in the dimension table in this catalogue.

Table 4. 5

L_h		f_h		L_h		f_h		L_h		f_h	
h	ball bearing	roller bearing	h	ball bearing	roller bearing	h	ball bearing	roller bearing	h	ball bearing	roller bearing
100	0.585	0.617	700	1.12	1.11	4600	2.1	1.95	34000	4.08	3.55
110	0.604	0.635	750	1.14	1.13	4800	2.13	1.97	36000	4.16	3.61
120	0.622	0.652	800	1.17	1.15	5000	2.15	2	38000	4.24	3.67
130	0.639	0.668	850	1.19	1.17	5500	2.22	2.05	40000	4.31	3.72
140	0.654	0.683	900	1.22	1.19	6000	2.29	2.11	42000	4.38	3.78
150	0.67	0.697	950	1.24	1.21	6500	2.35	2.16	44000	4.45	3.83
160	0.684	0.71	1000	1.26	1.23	7000	2.41	2.21	46000	4.51	3.88
170	0.698	0.723	1100	1.3	1.27	7500	2.47	2.25	48000	4.58	3.93
180	0.712	0.736	1200	1.34	1.3	8000	2.52	2.3	50000	4.64	3.98
190	0.724	0.748	1300	1.38	1.33	8500	2.57	2.34	55000	4.79	4.1
200	0.737	0.76	1400	1.41	1.36	9000	2.62	2.38	60000	4.93	4.2
220	0.761	0.782	1500	1.44	1.39	9500	2.67	2.42	65000	5.07	4.31
240	0.783	0.802	1600	1.47	1.42	10000	2.71	2.46	70000	5.19	4.4
260	0.804	0.822	1700	1.5	1.44	11000	2.8	2.53	75000	5.31	4.5
280	0.824	0.84	1800	1.53	1.47	12000	2.88	2.59	80000	5.43	4.58
300	0.843	0.858	1900	1.56	1.49	13000	2.96	2.66	85000	5.54	4.68
320	0.861	0.875	2000	1.59	1.52	14000	3.04	2.72	90000	5.65	4.75
340	0.879	0.891	2200	1.64	1.56	15000	3.11	2.77	100000	5.85	4.9
360	0.896	0.906	2400	1.69	1.6	16000	3.17	2.83			
380	0.913	0.921	2600	1.73	1.64	17000	3.24	2.88			
400	0.928	0.935	2800	1.78	1.68	18000	3.3	2.93			
420	0.944	0.949	3000	1.82	1.71	19000	3.36	2.98			
440	0.959	0.962	3200	1.86	1.75	20000	3.42	3.02			
460	0.973	0.975	3400	1.89	1.78	22000	3.53	3.11			
480	0.987	0.988	3600	1.93	1.81	24000	3.63	3.19			
500	1	1	3800	1.97	1.84	26000	3.7	3.27			
550	1.03	1.03	4000	2	1.87	28000	3.83	3.35			
600	1.06	1.06	4200	2.03	1.89	30000	3.91	3.42			
650	1.09	1.08	4400	2.06	1.92	32000	4	3.48			

Table 4. 6

n		f_n		n		f_n		n		f_n	
r/min	ball bearing	roller bearing	r/min	ball bearing	roller bearing	r/min	ball bearing	roller bearing	r/min	ball bearing	roller bearing
10	1.49	1.44	80	0.747	0.769	600	0.382	0.420	4600	0.194	0.228
11	1.45	1.4	85	0.732	0.755	650	0.372	0.410	4800	0.191	0.225
12	1.41	1.4	90	0.718	0.742	700	0.362	0.401	5000	0.188	0.222
13	1.37	1.33	95	0.705	0.730	750	0.354	0.393	5500	0.182	0.216
14	1.34	1.3	100	0.693	0.719	800	0.347	0.385	6000	0.177	0.211
15	1.31	1.27	110	0.672	0.699	850	0.340	0.378	6500	0.172	0.206
16	1.28	1.25	120	0.652	0.681	900	0.333	0.372	7000	0.168	0.201
17	1.25	1.23	130	0.635	0.665	950	0.327	0.366	7500	0.164	0.197
18	1.23	1.2	140	0.620	0.650	1000	0.322	0.360	8000	0.161	0.193
19	1.21	1.18	150	0.606	0.637	1100	0.312	0.350	8500	0.158	0.190
20	1.19	1.17	160	0.593	0.625	1200	0.303	0.341	9000	0.155	0.186
22	1.15	1.13	170	0.581	0.613	1300	0.2955	0.333	9500	0.152	0.183
24	1.12	1.1	180	0.570	0.603	1400	0.288	0.326	10000	0.149	0.181
26	1.09	1.08	190	0.560	0.593	1500	0.281	0.319	11000	0.145	0.176
28	1.06	1.05	200	0.550	0.584	1600	0.275	0.313	12000	0.141	0.171
30	1.04	1.03	220	0.533	0.568	1700	0.270	0.307	13000	0.137	0.167
32	1.01	1.01	240	0.518	0.553	1800	0.265	0.302	14000	0.134	0.163
34	0.994	0.99	260	0.504	0.540	1900	0.260	0.297	15000	0.131	0.160
36	0.975	0.98	280	0.492	0.528	2000	0.255	0.293	16000	0.128	0.157
38	0.958	0.96	300	0.481	0.517	2200	0.247	0.285	17000	0.125	0.154
40	0.941	0.95	320	0.471	0.507	2400	0.240	0.277	18000	0.123	0.151
42	0.926	0.93	340	0.461	0.498	2600	0.234	0.271	19000	0.121	0.149
44	0.912	0.92	360	0.452	0.490	2800	0.228	0.265	20000	0.119	0.147
46	0.898	0.91	380	0.444	0.482	3000	0.223	0.259	22000	0.115	0.143
48	0.885	0.9	400	0.437	0.475	3200	0.218	0.254	24000	0.112	0.139
50	0.874	0.89	420	0.430	0.468	3400	0.214	0.250	26000	0.109	0.136
55	0.846	0.86	440	0.423	0.461	3600	0.210	0.245	28000	0.106	0.133
60	0.822	0.84	460	0.417	0.455	3800	0.206	0.242	30000	0.104	0.130
65	0.8	0.82	480	0.411	0.449	4000	0.203	0.238			
70	0.781	0.800	500	0.405	0.444	4200	0.199	0.234			
75	0.763	0.784	550	0.393	0.431	4400	0.196	0.231			

Example:

Known: The shaft rotating speed of a machine $n=5000$ r/min, constant (equivalent) radial load carried by bearing $P=1000$ N, the selected bearing structure is deep groove ball bearing, the anticipated bearing service life is 8000h, try to calculate the size of suitable bearing.

Searching in the Table 4.5 and Table 4.6:

The corresponding speed factor of the deep groove ball bearing 5000r/min, $f_n=0.188$

The corresponding life factor of deep groove ball bearing 8000h, $f_h=2.52$

Introduce f_n , f_h into the equation:

$$C = \frac{f_n}{f_h} P = \frac{2.52}{0.188} \times 1000 = 13404N$$

Searching the deep groove ball bearing size table, bearing 6006E: $C=13300N$, smaller than calculated value, while bearing 6206E: $C=19500N$, bigger than calculated value. Considering the reliability of bearing service life, bearing 6206E

Table 4. 7

Operating Conditions	Operating Hours
Infrequently used instruments and machines	300~3000
Machines used for short periods or intermittently: Electric hand tools, agricultural machines, lifting tackle in workshops, automatic-feeder equipment.	3000~8000
Machines used intermittently, which will have serious result: auxiliary equipment of power plant, flow line driving device, rubber belt conveyor, workshop cranes.	8000~12000
Machines working 8 hours per day but infrequently at full capacity: electric motor, general gearing, crusher, cranes and normal machinery.	10000~25000
Machines working 8 hours per day at full capacity: machine tools, woodworking machinery, printing machinery, centrifuge.	20000~30000
Machines working continuously for 24 hours: compressor, pump, electric motor, rolling mill gearing, textile machinery.	40000~50000
Machines working continuously for 24 hours, intermittently working will have serious results: fiber machinery, paper machinery, primary device of power plant, water equipments, mine pump and ventilating fan.	~100000

4.4.2 Basic Rating Life

According to GB/T6391 <Rolling bearings Basic dynamic load rating and basic rating life>, the basic rating life can be calculated by the following formula:

$$L_{10} = \left(\frac{C}{P} \right)^{\epsilon}$$

where

L_{10} – Basic rating life, million of revolutions

should be better to choose.

4.4 Calculation of Bearing Life

4.4.1 Bearing Life

It is important for the customers to ensure the bearing service life. The estimation of extra long service life will cause the waste of resources or the increase of dimension; the matched parts dimension will increase accordingly. The estimation of extra short service life will result in changing bearings frequently and unnecessary work and waste of manpower and material; moreover it is harmful to the reliability of bearing service life.

Therefore, before ensuring the bearing service life, comprehensive evaluation should be made for the machinery category, all types of different working conditions and requirement of reliability etc.

The recommended values of service life for all types of machinery under different applications should refer to Table 4.7.

C – Basic dynamic load rating, N

P – Equivalent dynamic load, N

ϵ – Exponent of the life equation $\epsilon = 3$ for ball bearings $\epsilon = 10/3$ for roller bearings

For bearings operating at constant speed, rating life could be usually indicated by operating hours, and the calculating equation is:

$$L_{10h} = \frac{10^6}{60n} \left(\frac{C}{P} \right)^{\epsilon}$$

$$\text{or } L_{10h} = \frac{10^6}{60n} L_{10}$$

where

L_{10h} – Basic rating life indicated by hours, h

n – Working speed, r/min

The basic rating life of a vehicle bearing is usually indicated by kilometers, the formula of its rating life is:

$$L_{10s} = \frac{\pi D}{1000} L_{10}$$

Where

L_{10s} – Basic rating life indicated by kilometers, km

D – Wheel diameter, m

4.4.3 Modified Calculation of Bearing Life

The calculation precision of basic rating life L_{10} is satisfied for most applications. However, with the completeness of the bearings lubrication theory, the application of new technique and the improved material quality, there is new method for the calculation of bearing life. The modified calculation formula for bearing life is proposed in the Chinese standard GB/T 6391:

$$L_{na} = a_1 a_2 a_3 L_{10}$$

where

L_{na} – Modified basic rating life with the reliability (100-n) %, special bearing performance and certain operating conditions, N

a_1 – Reliability coefficient, shown in Table 4.8

a_2 – Material coefficient

a_3 – Working condition coefficient

For the bearing made of standard material, $a_2=1$. For high purity steel or special smelted steel, such as vacuum degassing steel, electroslag remelting steel, $a_2>1$

For a normal application, $a_3=1$. When a bearing is lubricated enough, and formed with the flexibility liquid film on the roller contact surface, $a_3>1$. If a bearing is not lubricated enough, the value of a_3 should be considered less than 1.

Please note, if bearing isn't lubricated enough, it couldn't exert as compensate effect for bearing life due to the improvement of material quality, so under this situation, the value of a_2 should not be more than 1.

Table 4. 8

Reliability S	L_{na}	a_1
90	L_{10}	1
95	L_5	0.62
96	L_4	0.53
97	L_3	0.44
98	L_2	0.33
99	L_1	0.21

5. Friction

Friction still exists, even though the friction of rolling bearing is much lower than that of sliding bearing. Friction is the main reason of bearing heating, friction forms kinetic resistance and creates dimensional variation with in the components. Friction is also one of the key factors which determine the bearing working temperature. The sum of the friction in rolling bearings is considered as the running resistance of bearings to be measured, which, could be expressed as drag or torque and called friction moment in bearing application.

The total resistance generated from the bearing running is composed of rolling friction and sliding friction. According to its generation mechanism, the main sources of friction can be divided into the following parts:

- Pure rolling friction cause by material elastic hysteresis
- Friction caused by differential sliding on rolling contact surface
- Friction caused by spin sliding
- Friction of sliding contact places
- Viscous friction of lubricants
- Friction caused by slant mounting of bearing axis
- Other frictions

From the generation mechanism of bearing friction, friction moment have the characteristic of multiple-factors and randomness. The friction moment has changes even though bearings with same structure and size are under the same working condition. The moment needed from static state to running is called starting friction moment. While the friction running under a certain speed after starting is pivoting friction torque, which, is often expressed by average friction torque and max friction torque.

5.1 Friction Moment Calculation

Bearings have different requirements of friction moment under different working conditions. Generally, for the bearing running continuously the smaller of the average friction, this is better for bearings starting frequently or having the requirement of bidirectional rotation, smaller start friction moment is needed. Bearings for instruments with high sensitivity require that the max friction moment should be small and maintain stability.

The friction moment calculation has two methods of proximate calculation and accurate calculation.

5.1.1 Proximate Calculation

The friction was decided by bearing structure,

type, load capacity, speed, lubrication performance and volume, proximate calculation of friction moment M can be according to the formula below:

$$M = 0.5 \mu Fd$$

where

- μ — Coefficient, shown in Table 5.1
- F — Bearing load, N
- d — Inner diameter of bearing, mm

Table 5.1

Bearing Type	Friction Coefficient μ
Deep groove ball bearing	0.0015
Angular contact ball bearing	
Single row	0.0020
Double row	0.0024
Four-point contact	0.0024
Self-aligning ball bearing	0.0010
Cylindrical roller bearing	
With cage ($F_a=0$)	0.0011
Full rollers ($F_a=0$)	0.0020
Taper roller bearing	0.0018
Spherical roller bearing	0.0018
Thrust ball bearing	0.0013
Thrust cylindrical roller bearing	0.0050
Thrust taper roller bearing	0.0018

The above formula is only suited for the average friction moment calculation under good lubrication, medium load and speed.

5.1.2 Accurate Calculation

Accurate calculation formula:

$$M = M_0 + M_1$$

where

M_0 — Friction moment related to bearing type, speed and lubricant, N • mm

M_1 — Friction moment related to bearing load, N • mm

• Calculation for M_0

M_0 reflects the hydrokinetic loss of lubricant, which, could be calculated as the following equation:

when $vn \geq 2000$

$$M_0 = f_0(vn)^{2/3} d m^3 \cdot 10^{-7}$$

when $vn < 2000$

$$M_0 = 160 \times 10^{-7} f_0 d m^3$$

where d_m — Bearing average diameter, $d_m = 0.5(d+D)$, mm

f_0 — Coefficient related to the bearing type and lubricant, value of f_0 refers to Table 5.2; select smaller value of f_0 for the light series, and larger value of f_0 for the heavy series

n — Bearing speed, r/min

ν — Kinematic viscosity of lubricant under working temperature (grease refer to the viscosity of basic oil), mm^2/s

• Calculation for M_1

M_1 reflects all kinds of friction loss related to loads, which, could be calculated as the following equation:

$$M_1 = f_1 P_1 d_m$$

where f_1 — Coefficient related to bearing load, refer to Table 5.3

P_1 — Assumed load ensured the bearing friction moment, N refers to Table 5.3

If a cylindrical roller bearing carries the combined effect of radial load and axial load simultaneously, additional friction moment M_2 should be considered:

$$M_2 = f_2 F_a d_m$$

Total friction moment:

$$M = M_0 + M_1 + M_2$$

where

f_2 — Coefficient related to bearing structure and lubrication method, its value is shown in Table 5.4

F_a — Bearing axial load, N

Table 5.2

Bearing Type	Oil Mist Lubrication	Bath Lubrication or Grease Lubrication	Vertical Shaft Bath Lubrication or Oil Jet Lubrication
Single-row deep groove ball bearing	0.7~1	1.5~2	3~4
Double-row self-aligning ball bearing	0.7~1	1.5~2	3~4
Single-row angular contact ball bearing	1	2	4
Double-row angular contact ball bearing	2	4	8
Cylindrical roller bearing(With cage)	1~1.5	2~3	4~6
Cylindrical roller bearing (full-fill components)	-	2.5~4	-
Spherical roller bearing	2~3	4~6	8~12
Taper roller bearing	1.5~2	3~4	6~8
Thrust ball bearing	0.7~1	1.5~2	3~4
Thrust cylindrical roller bearing	-	2.5	5
Thrust spherical roller bearing	-	3~4	6~8

Table 5.3

Bearing Type	f_1	P_1 ①
Single row deep groove ball bearing	0.0009 (P_0/C_0) ^{0.5}	3Fa-0.1Fr
Single row angular contact ball bearing	0.0003 (P_0/C_0) ^{0.4}	1.4yFa-0.1Fr
Double-row angular contact ball bearing	0.0013 (P_0/C_0) ^{0.33}	Fa-0.1Fr
Double-row angular contact point	0.001 (P_0/C_0) ^{0.33}	1.4Fa-0.1Fr
Cylindrical roller bearing(With cage)	0.00025~0.0003②	Fr
Cylindrical roller bearing(full-fill components)	0.00045	Fr
Spherical roller bearing	0.0004~0.0005②	1.2yFa
Taper roller bearing	0.0004~0.0005②	2yFa
Thrust ball bearing	0.0012 (P_0/C_0) ^{0.33}	Fa
Thrust cylindrical roller bearing	0.0018	Fa
Thrust spherical roller bearing	0.0004~0.0006②	Fa (F _{rmax} ≤ 0.55 Fa)

- Note:
- ① If $P_1 < Fr$, then $P_1 = Fr$.
 - ② For light series, smaller value should be chosen; for heavy series, bigger value should be chose.
 - ③ In the table above, P_0 is bearing equivalent static load, N.
 C_0 is bearing rating static load, N.
 y is axial load factor when $F_a / Fr > e$.

Table 5.4

Bearing Structure	Oil Lubrication	Grease Lubrication
With cage	0.006	0.009
Full component roller	0.003	0.006

Q — Heating value, W
M — Friction moment, N • mm
n — Speed, min/r

When the heating value and output heat reach to a balance, the temperature of bearing maintains stability.

The value of f_2 is fit for $K_v = 1.5$, K_v is the ratio between the chosen lubricant viscosity and the practical viscosity when bearing is operating.

5.2 Power Consumption

Power consumption caused by friction can be calculated as follows:

$$Q = 1.05 \times 10^{-6} M \cdot n$$

where

6. Limiting Speed

Limiting speeds of bearings mainly depend on the relation between friction heating (including other outside heat) and discharged heat during rotation. It is not only related to the lubricant and temperature of the bearing components material, but also related to the bearing structures, dimensions, clearances, loads, cage structures, material, guiding methods, lubrication method, volume, and bearing cooling conditions.

The suitable conditions of bearing limiting speeds given in the dimension table in this catalogue are:

- Bearing with standard structure
- Under the temperature 20°C, the temperature rising of bearing is 50°C, i.e. the measured working temperature is 70°C on the outer ring or housing washer without rotation
- Equivalent dynamic loading $P \leq 0.1C$
- The structure of rigidly connected shaft and housing washer
- Open bearing with normal precision, clearance group 0 (basic group)
- Radial bearings only carry radial loads; thrust bearings only carry axial loads
- Sufficient lubricating

For oil lubrication

Lubricant: mineral oil without extreme pressure additives, and kinetic viscosity under 70°C is:

$$\begin{aligned} \text{For axial bearing} \quad v &= 12 \text{ mm}^2/\text{s} \\ \text{For thrust bearing} \quad v &= 24 \text{ mm}^2/\text{s} \end{aligned}$$

Lubrication method: bath lubrication, oil level is at the center of lowest Rolling elements

For grease lubrication

Lubricant: Lithium-based oil lubrication, viscosity(40°C)
100~200mm²/s

Filling volume of grease: about 30% of the bearing internal free space.

In practice, working conditions often don't conform to the above conditions, e.g. $P > 0.1C$, or radial bearing carrying combined radial and axial loads, or inadequate lubrication, or excessive lubricants etc. At this time, the actual highest working speed of bearing will be lower than the given (reference) limiting speed in this catalogue, so the speed drop coefficient f_1 and f_2 should be introduced to modify the value of the coefficient could be selected according to Fig 6.1 and Fig 6.2. Modified limiting speed could be calculated according to the following formula:

$$n_a = f_1 \cdot f_2 \cdot n_{\text{limit}}$$

where

n_{limit} — Limiting speed given in this catalogue
 f_1, f_2 — Modified coefficient of limiting speed

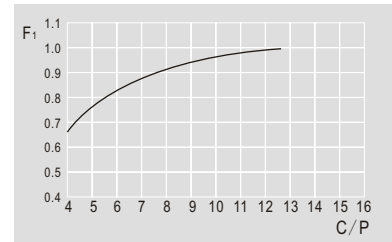

Fig 6.1

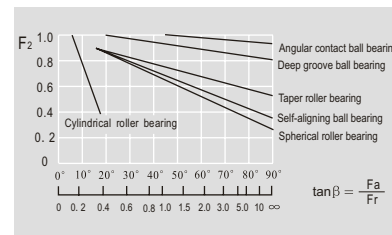

Fig 6.2

If the limiting speed given in this catalogue could not meet the application requirement, the following methods can be adopted to improve the limiting speed:

- Improve the bearing precision
- Increase the clearance value appropriately
- Adopt cages made by light material or with special designed structure, and adjust the guiding method of the cages
- Improve the lubrication ways, e.g. circular oil lubrication, oil jet or oil mist lubrication
- More efficient cooling

7. Materials

The basis of bearing quality is material, which, has great influence on bearing performance, life and reliability. The rolling surface of components carries periodical alternating loads during operation, extremely high contact stress (1000~4000MPa) is generated on the contact position due to the small contact area between rolling elements and raceway. The material of components will fatigue under the repeated actions of the stress, which results in the fatigue flake. Meanwhile, both rolling friction and sliding friction exist at the component contact position. Therefore, the bearing material should have the following performances:

- High contact fatigue intensity
- High flexibility limit
- High material purity
- High hardness obtained
- Good abrasion resistance and anticorrosion
- Good structure stability
- Good machining property
- Good impact resistance

To ensure LYC's bearings with perfect performance and reliability, the bearings are made of various high quality steels.

The main bearings materials adopted by LYC are given.

7.1 Material of Bearing Rings and Rolling Elements

7.1.1 Fully Hardening Steel

Most bearing rings and rolling elements of LYC's bearings are all made of through-hardening high-carbon chromium bearing steel. Most common used steel brands are GCr15, GCr15SiMn or GCr18Mo. High-carbon chromium bearing steel is one of the most common steels with longest history and most comprehensive research. Steel GCr18Mo is an example of good impact resistance steel developed recently.

The hardness of high-carbon chromium bearing steel could reach 58~65HRC after martensitic or bainitic heat treatment, other performance index could also meet the bearing application requirements.

7.1.2 Case-Hardening Steel

Bearings carrying heavy impact load in application such as the railway bearing, rolling mill bearing and bearings with larger interference can be made by all brands of carburized steel.

The hardness of carburized steel could be around

60HRC after case-carburizing and heat treatment, while its central structure has good toughness (30~35HRC), which, is fit for the applications with heavy impact load.

The main brands of carburized steel used by LYC are 20CrNi2MoA, 20Cr2Ni4A, 10CrNi3MoA, 15CrNi4MoA etc.

7.1.3 Induction Hardening Steel

The partial surface of components (e.g. raceway) could be hardened by the method of induction hardening, and other surfaces are not influenced, so material of the same component could have different performance. Induction hardening steels 42CrMo, 50Mn and 5CrMnMo are commonly used by LYC.

7.1.4 High-Temperature Bearing Steel

Bearings made by high-carbon chromium bearing steel and case-hardening steel should operate under the temperature below 120°C. If working temperature is higher than 120°C, then special heat treatment for stability should be made. The material after stabilizing treatment could reach the highest temperature 350°C, but, the load capacity, abrasion resistance of bearing will reduce under this situation and only be suitable to work under high temperature for a short period. Bearings with working temperature over 350°C or working under temperature over 250°C for a long period need to be made of high-temperature bearing steel.

High-temperature bearing steels Cr4Mo4V, W18Cr4V are often used by LYC.

LYC also supply bearings made of stainless steels, anticorrosion steels, vacuum degassing steels, electro-slag refined steels etc. Bearings made of such high quality and material purity steels should satisfy customers' individuation, multi-performance and long service life requirements, but their prices will be different from bearings made of normal materials.

The bearings made of different materials, except high-carbon chromium bearing steel, need to add supplementary suffix codes for materials, and all kinds of material code can be found in bearing code part of this catalogue.

7.2 Materials for Cage

The main function of cage is :

- Segregate the rolling elements and prevent contact friction between them.
- For separable bearings, cages retain the rolling elements on the raceway, which are good for mounting and dismounting of

bearing.

- Guiding the movement of rolling elements, such as the cage of needle bearings and thrust ball bearings.
- In grease lubrication, cage could have the effect of storing the grease to improve the bearing lubrication surface of the bearing.

The cage supports mixed strength during operation, such as friction between elements (or rings), the commutation strength of cage beam, and the remaining strength during high speed. Because of the difference in the bearing type and size, structures of cages are also different, the differences include structures of cage, material, manufacturing methods, production cost and so on. Depending on technological procedure of cages, these should be classified as pressed steel cage, injection mold cages, machined solid cage etc.

7.2.1 Pressed Steel Cage

Most pressed steel cages are made of a cold (hot) strip of low carbon, such as 10# steel. Cages made of these materials have high strength and can reduce friction abrasion through surface treatment, and internal stress caused by pressing procedure.

Pressed steel cages are mostly used for medium and small bearings.

Pressed steel cages could also be made of brass strips.

7.2.2 Machined Solid Cage

According to the materials of cages, machined solid cages mainly include steel cages and brass cages. Aluminum ZL102, powder metallurgy or phenolic compress tube are also used in some applications.

The blank of steel cages and brass cages can be casted or forged.

• Steel Cages

The mechanical strength of machined steel cages is superior to that of pressed steel cages. Some

steel cages should be surface treated to improve the capacity of antifriction and abrasion resistance. Machined solid steel cages are usually used for larger size bearings, or in the application unsuitable for brass cages, e.g. the application that brass is naturally fractured due to chemical reaction.

The highest operating temperature for machined solid steel cages is 300°C, and usually isn't influenced by mineral oil or synthetic lubricant and organic solvent for cleaning.

The main materials for machined steel cages are steel 20#, 30# etc.

• Brass Cages

Machined solid brass cages are usually used for medium and small size bearings. Brass cages aren't usually affected by bearing lubrication, and could be cleaned by normal organic solvent. Brass cages are not suitable for working application with the temperature over 250°C.

The materials for brass cages are mainly brass CuZn40Pb2, bronze CuAl10Fe3Mn2 etc.

7.2.3 Injection Mold Cages

Most injection mold cages are made of staple glass fiber reinforced nylon 66. These materials have good intensity, flexibility and gliding, and can keep working for some time under the situation of oil starvation.

When adopting injection mold cages made of reinforced nylon 66, the influences of allowed working temperature (Table 7.1) and lubricants corrosion should be noticed. If bearings work under allowable temperature, the performance of nylon cages isn't influenced, and if exceeding this temperature, the material will be aging.

Because nylon will lose flexibility at low temperature, nylon cages are not fit for bearings continuously working under the temperature -40°C. Under the vacuum conditions, nylon will become crisp due to dehydration, so nylon cages should not be adopted.

7.3 Material for Seals

The seals used by LYC are often made by nitrile rubber (NBR). NBR has a good carrying capacity toward the following medium:

- Most of mineral oil and mineral oil grease
- General Fuel, such as gasoline, diesel oil and other liquid fuel
- Animal oil, vegetable oil and fat
- Hot water

NBR seals may be allowed to operate in a short time under oil starvation conditions. The working temperature of NBR is -40°C ~ +100°C, and can reach 120°C for short time, if exceeding this temperature, NBR will harden and lose its performance.

8. General Data

8.1 Boundary Dimensions

The boundary dimensions and dimension series of LYC standard bearings conform to Chinese national standards, as follows:

- GB/T273.1 <Rolling bearings-Boundary dimensions general plan-part 1: Tapered roller bearings>
- GB/T273.2 <Rolling bearing-Thrust bearings-Boundary dimensions, general plan>
- GB/T273.3 <Rolling bearing-Radial bearings-Boundary dimensions, general plan>
- GB/T274 <Rolling bearing-Chamfer dimension-Maximum Values>
- Other related standards

Inch sized taper roller bearings conform to American national standard ANSI.

Each type of standard bearing is indicated by dimension series code made by diameter series and width series. Dimension series is indicated by double figures, the first one is width series (or height series), and the second one is diameter series.

Diameter series means bearings with the same standard inner diameter have different outer diameters at radial direction. Diameter series of radial bearings are divided into 7, 8, 9, 0, 1, 2, 3, 4 series, which is in the order of increasing of outer diameter. Similarly, diameter series of thrust bearings is 0, 1, 2, 3, 4, 5 series.

Width series means bearings with the same standard inner diameter have different widths at axial direction. Width series of radial bearings are divided into 8, 0, 1, 2, 3, 4, 5, 6 series, which is in the order of increasing of outer diameter. Similarly, diameter series of thrust bearings is 7, 9, 1, 2 series.

Dimension series is shown in Fig 8.1.

Example: 6202E

where

"02"- dimension series

"0"- height series

"2"- diameter series

In recent years, with the increasing requirement for the individualization of bearing performance, there appear many non-standard bearings with the variation of structures or outer dimensions. So when reorganizing the catalogue, part of non-standard bearings are added to meet the needs of some special customers.

8.2 Chamfer Dimensions

In order to ensure the close fit of rolling bearing with matched parts, the chamfer dimensions of LYC standard bearings conform to the stipulations of national standard GB/T 274 <Rolling Bearing Maximum Value of Chamfer>.

8.3 Tolerances

The tolerance of LYC standard bearings conforms to Chinese national standards:

- GB/T307.1 <Roller Bearing Radial Bearings Tolerance>
- GB/T273.2 <Roller Bearing Thrust Bearings Tolerance >

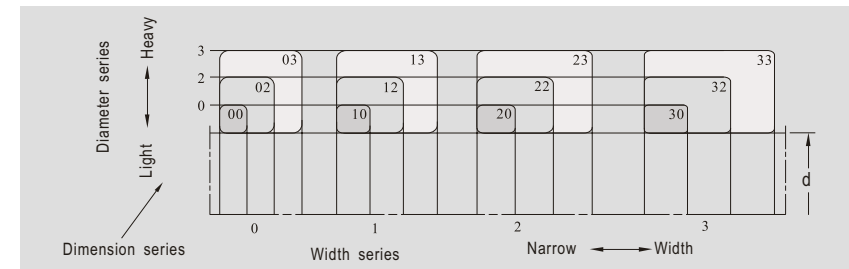

Fig 8.1

Table 7. 1

Lubricant		Allowable Working Temperature (°C)
Mineral oil	Lubricant without extreme pressure additive, such as engine oil, hydraulic oil	120
	Lubricant with extreme pressure additive, such as industrial and automobile gear oil	110
	Lubricant with extreme pressure additive, such as back axle and differential gear oil, hypoid gear oil	100
Synthetic oil	Polyglycol ether	120
	Oxalic acid, diester, silicon oil	110
	Organic phosphate	80
Grease	Lithium base, polyurea base, bentonite, complex calcium lubricating grease	120

The tolerance of special bearings such as rolling mill bearings, machine tool spindle bearings and inch size bearings, execute their related stipulations separately.

The dimension and rotating accuracy of rolling bearing have been internationalized (Table 8.1). According to the stipulations in national standard, the dimension and rotating accuracy of metric bearings are divided into five tolerance classes, class 0, class 6, class 5, class 4, class 2, and the precision classes are increasing in sequence.

Table 8.1

Code	Tolerance Class				
LYC	0	6	5	4	2
ISO	0	6	5	4	2
SKF	0	P6	P5	P4	
JIS	0	6	5	4	
DIN	0	P6	P5	P4	
ANSI	ABEC1 RBEC2		ABEC5 RBECS	ABEC7	ABEC9

8.3.1 Tolerance Symbols

- d** Bearing bore diameter, nominal
- Δd_s Deviation of a single bore diameter
- Δd_{mp} Single plane mean bore diameter deviation (for a tapered bore, refers only to the theoretical small end of bore)
- V_{dp}** Bore diameter variation in a single radial plane
- V_{dmp}** Mean bore diameter variation (only applies to a cylindrical bore)
- D** Bearing outer diameter, nominal
- D₁** Outer ring flange outer diameter, nominal
- ΔD_s Deviation of a single outer diameter
- ΔD_{1s} Deviation of outer flange of a single outer ring
- ΔD_{mp} Single plane mean outer diameter deviation
- VD_p** Outer diameter variation in a single radial plane
- VD_{dmp}** Mean outer diameter variation
- B** Inner ring width, nominal shaft washer
- ΔB_s Deviation of a single width of the inner ring
- V_{Bs}** Inner ring width variation
- C** Outer ring width, nominal
- C₁** Outer flange width, nominal
- Δc_s Deviation of a single width of the outer ring
- V_{cs}** Outer ring width variation
- K_{ia}** Radial runout of assembled bearing inner ring
- K_{ea}** Radial runout of assembled bearing outer ring
- S_d** Verticality of end face of inner ring towards bore
- S_o** Verticality of outer surface of outer ring

- towards end face
- S_{o1}** Verticality of outer surface of outer ring towards flange backface
- S_{ia}** Axial runout of assembled bearing inner ring
- S_{ea}** Axial runout of assembled bearing outer ring
- S_{ea1}** Axial runout of assembled bearing flange backface

Added Tolerance Symbols of Taper Roller Bearing

- T** Bearing width, nominal
- T₁** Bearing nominal width composed by sub-unit and standard outer ring
- T₂** Bearing nominal width composed by outer ring and standard sub-unit
- ΔT_s Deviation of the actual bearing width
- ΔT_{1s} Actual deviation of T₁
- ΔT_{2s} Actual deviation of T₂

8.3.2 Tolerance Values

- The tolerance values for radial bearings (except taper roller bearings) are given in Table 8.2-8.11
- The tolerance values for taper roller bearings are given in Table 8.12-8.19
- The tolerance values for radial bearings with flange are given in Table 8.20
- The tolerance values of taper bore are given in Table 8.21-8.22
- The tolerance values of thrust bearing are given in Table 8.23-8.30
- Maximum values of chamfer are given in Table 8.31-8.35

8.4 Bearing Clearance

8.4.1 Basic Concept

Bearing clearance is including radial internal clearance and axial internal clearance.

Radial clearance: when bearings do not carry any outer loads in different directions, the arithmetic mean value of radial distance that the one bearing ring relative to the other bearing ring moves from one radial eccentricity limit to the opposite limit position.

Axial clearance: when bearings do not carry any outer loads, the mean value of radial distance that the one bearing ring relative to the other bearing ring moves from one axial limit position to the opposite limit position.

Radial and axial clearances are shown in Fig 8.7.

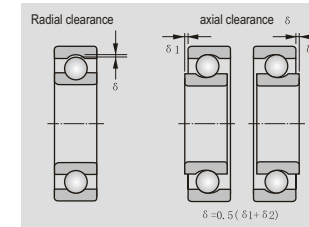

Fig 8.7

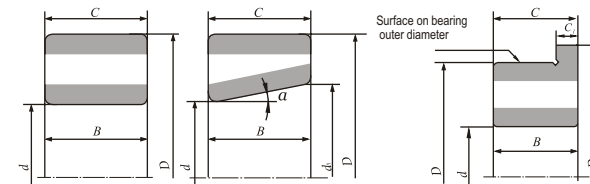

Fig 8.2 Boundary dimension symbols

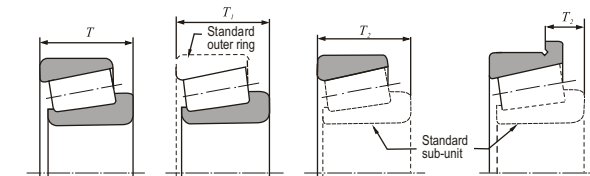

Fig 8.3 Additional symbols for tapered roller bearings

Table 8.2 Radial Bearings (except taper roller bearings)

d mm		Δd_{mp}		Tolerance class 0			Inner ring		μm			
				$V_{dp}^{(2)}$			V_{dmp}	K_{ia}	ΔB_s			V_{Bs}
				Diameter Series					All	Normal	Modified ⁽³⁾	
over	incl	high	low	9	0,1	2,3,4	max	max	high	low	max	
0,6 ⁽¹⁾	2,5	0	-8	10	8	6	6	10	0	-40	-	12
2,5	10	0	-8	10	8	6	6	10	0	-120	-250	15
10	18	0	-8	10	8	6	6	10	0	-120	-250	20
18	30	0	-10	13	10	8	8	13	0	-120	-250	20
30	50	0	-12	15	12	9	9	15	0	-120	-250	20
50	80	0	-15	19	19	11	11	20	0	-150	-380	25
80	120	0	-20	25	25	15	15	25	0	-200	-380	25
120	180	0	-25	31	31	19	19	30	0	-250	-500	30
180	250	0	-30	38	38	23	23	40	0	-300	-500	30
250	315	0	-35	44	44	26	26	50	0	-350	-500	35
315	400	0	-40	50	50	30	30	60	0	-400	-630	40
400	500	0	-45	56	56	34	34	65	0	-450	-	50
500	630	0	-50	63	63	38	38	70	0	-500	-	60
630	800	0	-75	-	-	-	-	80	0	-750	-	70
800	1000	0	-100	-	-	-	-	90	0	-1000	-	80
1000	1250	0	-125	-	-	-	-	100	0	-1250	-	100
1250	1600	0	-160	-	-	-	-	120	0	-1600	-	120
1600	2000	0	-200	-	-	-	-	140	0	-2000	-	140

- Note: 1) Including 0.6.
- 2) No stipulated values for diameter series 7 and 8.
- 3) This refers to the inner rings of single bearings made for paired or stack mounting.

Table 8.3 Radial Bearings (except taper roller bearings)

Tolerance class 0 Outer ring

D mm		ΔD_{mp}		$V_{Dp}^{2,4)}$				$V_{Dmp}^{4)}$	K_{ea}	$\Delta C_s^{5)}$		$V_{Cs}^{5)}$
				Open Bearings		Capped ³⁾ Bearings						
				Diameter Series								
				9	0,1	2,3,4	2,3,4					
over	incl	high	low	max				max	max	high	low	max
2.5 ¹⁾	6	0	-8	10	8	6	10	6	15			
6	18	0	-8	10	8	6	10	6	15			
18	30	0	-9	12	9	7	12	7	15			
30	50	0	-11	14	11	8	16	8	20			
50	80	0	-13	16	13	10	20	10	25			
80	120	0	-15	19	19	11	26	11	35			
120	150	0	-18	23	23	14	30	14	40			
150	180	0	-25	31	31	19	38	19	45			
180	250	0	-30	38	38	23	-	23	50			
250	315	0	-35	44	44	26	-	26	60			
315	400	0	-40	50	50	30	-	30	70			
400	500	0	-45	56	56	34	-	34	80			
500	630	0	-50	63	63	38	-	38	100			
630	800	0	-75	94	94	55	-	55	120			
800	1000	0	-100	125	125	75	-	75	140			
1000	1250	0	-125	-	-	-	-	-	160			
1250	1600	0	-160	-	-	-	-	-	190			
1600	2000	0	-200	-	-	-	-	-	220			
2000	2500	0	-250	-	-	-	-	-	250			

Note : The tolerance provision for outer ring flange outer diameter, see table 8.20

- Including 2.5.
- No values have been established for diameter series 7 and 8.
- No values have been established for diameter series 9, 0 and 1.
- Applies before mounting and after removal of internal or external snap ring.
- This only apply to deep groove ball bearings.

Table 8.4 Radial Bearings (except taper roller bearings)

Tolerance class 6 Inner ring

d mm		Δd_{mp}		$V_{dp}^{2)}$				V_{dmp}	K_{ia}	ΔB_s			V_{Bs}
				Diameter Series									
				9	0,1	2,3,4	All			Normal	Modified ³⁾		
				max			high			low			
over	incl	high	low	max			max	high	low		max		
0.6 ¹⁾	2.5	0	-7	9	7	5	5	5	0	-40	-	12	
2.5	10	0	-7	9	7	5	5	6	0	-120	-250	15	
10	18	0	-7	9	7	5	5	7	0	-120	-250	20	
18	30	0	-8	10	18	6	6	8	0	-120	-250	20	
30	50	0	-10	13	10	8	8	10	0	-120	-250	20	
50	80	0	-12	15	15	9	9	10	0	-150	-380	25	
80	120	0	-15	19	19	11	11	13	0	-200	-380	25	
120	180	0	-18	23	23	14	14	18	0	-250	-500	30	
180	250	0	-22	28	28	17	17	20	0	-300	-500	30	
250	315	0	-25	31	31	19	19	25	0	-350	-500	35	
315	400	0	-30	38	38	23	23	30	0	-400	-630	40	
400	500	0	-35	44	44	26	26	35	0	-450	-	45	
500	630	0	-40	50	50	30	30	40	0	-500	-	50	

- Note :
- Including 0.6.
 - No values have been established for diameter series 7 and 8.
 - This refers to the inner rings of single bearings made for paired or stack mounting.

Table 8.5 Radial Bearings (except taper roller bearings)

Tolerance class 6 Outer ring

D mm		ΔD_{mp}		$V_{Dp}^{2,4)}$				$V_{Dmp}^{4)}$	K_{ea}	$\Delta C_s^{5)}$		$V_{Cs}^{5)}$
				Open Bearings		Capped ³⁾ Bearings						
				Diameter Series								
				9	0,1	2,3,4	2,3,4					
over	incl	high	low	max				max	max	high	low	max
2.5 ¹⁾	6	0	-7	9	7	5	9	5	8			
6	18	0	-7	9	7	5	9	5	8			
18	30	0	-8	10	8	6	10	6	9			
30	50	0	-9	11	9	7	13	7	10			
50	80	0	-11	14	11	8	16	8	13			
80	120	0	-13	16	16	10	20	10	18			
120	150	0	-15	19	19	11	25	11	20			
150	180	0	-18	23	23	14	30	14	23			
180	250	0	-20	25	25	15	-	15	25			
250	315	0	-25	31	31	19	-	19	30			
315	400	0	-28	35	35	21	-	21	35			
400	500	0	-33	41	41	25	-	25	40			
500	630	0	-38	48	48	29	-	29	50			
630	800	0	-45	56	56	34	-	34	60			
800	1000	0	-60	75	75	45	-	45	75			

Note : The tolerance provision for outer ring flange outer diameter, see table 8.20

- Including 2.5.
- No values have been established for diameter series 7 and 8.
- No values have been established for diameter series 9.
- Applies before mounting and after removal of internal or external snap ring.
- This only applies to deep groove ball bearings.

Table 8.6 Radial Bearings (except taper roller bearings)

Tolerance class 5 Inner ring

d mm		Δd_{mp}		$V_{dp}^{2)}$				V_{dmp}	K_{ia}	S_d	$S_{ia}^{3)}$	ΔB_s			V_{Bs}
				Diameter Series											
				9	0,1,2,3,4	All	Normal					Modified ³⁾			
				max			high					low			
over	incl	high	low	max			max	max	max	high	low		max		
0.6 ¹⁾	2.5	0	-5	5	4	3	4	4	7	7	0	-40	-250	5	
2.5	10	0	-5	5	4	3	4	4	7	7	0	-40	-250	5	
10	18	0	-5	5	4	3	4	4	7	7	0	-80	-250	5	
18	30	0	-6	6	5	3	4	4	8	8	0	-120	-250	5	
30	50	0	-8	8	6	4	5	8	8	8	0	-120	-250	5	
50	80	0	-9	9	7	5	5	8	8	8	0	-150	-250	6	
80	120	0	-10	10	8	5	6	9	9	9	0	-200	-380	7	
120	180	0	-13	13	10	7	8	10	10	10	0	-250	-380	8	
180	250	0	-15	15	12	8	10	11	11	11	0	-300	-500	10	
250	315	0	-18	18	14	9	13	13	15	15	0	-350	-500	13	
315	400	0	-23	23	18	12	15	15	20	20	0	-400	-630	15	

- Note :
- Including 0.6.
 - No values have been established for diameter series 7 and 8.
 - This only applies to deep groove ball bearings.
 - This refers to the inner rings of single bearings made for paired or stack mounting.

Table 8.7 Radial Bearings (except taper roller bearings)

Tolerance class 5 Outer ring												μm		
D mm		Δ Dmp		VDp ⁽²⁾³⁾		VDmp	K _{ea}	SD ⁽⁴⁾	S _{ea} ⁽⁴⁾⁵⁾	S _{ea1} ⁽⁴⁾⁵⁾	Δ C _s ⁽⁵⁾	V _{cs} ⁽⁵⁾	Diameter Series	
													9 0,1,2,3,4	
													over	incl
2.5 ¹⁾	6	0	-5	5	4	3	5	8	8	11		5		
6	18	0	-5	5	4	3	5	8	8	11		5		
18	30	0	-6	6	5	3	6	8	8	11		5		
30	50	0	-7	7	5	4	7	8	8	11		5		
50	80	0	-9	9	7	5	8	8	10	14		6		
80	120	0	-10	10	8	5	10	9	11	16		8		
120	150	0	-11	11	8	6	11	10	13	18	Identical to ΔBs and Vbs of inner ring of same bearing	8		
150	180	0	-13	13	10	7	13	10	14	20		8		
180	250	0	-15	15	12	8	15	11	15	21		10		
250	315	0	-18	18	14	9	18	13	18	25		11		
315	400	0	-20	20	15	10	20	13	20	28		13		
400	500	0	-23	23	17	11	23	15	23	33		15		
500	630	0	-28	28	21	14	25	18	25	35		18		
630	800	0	-35	35	26	18	30	20	30	42		20		

Note : The tolerance provision for outer ring flange outer diameter, see table 8.20

- 1) Including 2.5.
- 2) No values have been established for diameter series 7 and 8.
- 3) No values have been established for capped bearings.
- 4) It does not apply to bearings with flange.
- 5) This only applies to deep groove ball bearings.

Table 8.8 Radial Bearings (except taper roller bearings)

Tolerance class 4 Inner ring												μm			
d mm		Δ dmp		Δ ds ⁽²⁾		VDp ⁽²⁾		VDmp	K _{ia}	S _d	S _{ia} ⁽³⁾	Δ Bs			V _{Bs}
												Diameter Series			
												9	0,1,2,3,4		
over	incl	high	low	high	low	max	max	max	max	max	high	Normal	Modified ⁵⁾	max	
0.6 ¹⁾	2.5	0	-4	0	-4	4	3	2	2.5	3	3	0	-40	-250	2.5
2.5	10	0	-4	0	-4	4	3	2	2.5	3	3	0	-40	-250	2.5
10	18	0	-4	0	-4	4	3	2	2.5	3	3	0	-80	-250	2.5
18	30	0	-5	0	-5	5	4	2.5	4	4	3	0	-120	-250	2.5
30	50	0	-6	0	-6	6	5	3	4	4	4	0	-120	-250	3
50	80	0	-7	0	-7	7	5	3.5	4	5	5	0	-150	-250	4
80	120	0	-8	0	-8	8	6	4	5	5	5	0	-200	-380	4
120	180	0	-10	0	-10	10	8	5	6	6	7	0	-250	-380	5
180	250	0	-12	0	-12	12	9	6	7	7	8	0	-300	-500	6

- Note:
- 1) Including 0.6.
 - 2) This only applies to diameter series 0,1,2,3 and 4.
 - 3) No values have been established for diameter series 7 and 8.
 - 4) This only applies to deep groove ball bearings.
 - 5) This refers to the inner rings of single bearings made for paired or stack mounting.

Table 8.9 Radial Bearings (except taper roller bearings)

Tolerance class 4 Outer ring												μm				
D mm		Δ Dmp		Δ Da ⁽²⁾³⁾⁴⁾		VDp ⁽³⁾⁴⁾		VDmp	K _{ea}	SD ⁽⁵⁾	S _{ea} ⁽⁵⁾⁶⁾	S _{ea1} ⁽⁶⁾	Δ C _s	V _{cs}	Diameter Series	
															9 0,1,2,3,4	
															over	incl
2.5 ¹⁾	6	0	-4	0	-4	4	3	2	3	4	5	7		2.5		
6	18	0	-4	0	-4	4	3	2	3	4	5	7		2.5		
18	30	0	-5	0	-5	5	4	2.5	4	4	5	7		2.5		
30	50	0	-6	0	-6	6	5	3	5	4	5	7		2.5		
50	80	0	-7	0	-7	7	5	3.5	5	4	5	7		3		
80	120	0	-8	0	-8	8	6	4	6	5	6	8	Identical to ΔBs and Vbs of inner ring of same bearing	4		
120	150	0	-9	0	-9	9	7	5	7	5	7	10		5		
150	180	0	-10	0	-10	10	8	5	8	5	8	11		5		
180	250	0	-11	0	-11	11	8	6	10	7	10	14		7		
250	315	0	-13	0	-13	13	10	7	11	8	10	14	7			
315	400	0	-15	0	-15	15	11	8	13	10	13	18	8			

Note : The tolerance provision for outer ring flange outer diameter, see table 8.20

- 1) Including 2.5.
- 2) This only applies to diameter series 0,1,2,3 and 4.
- 3) No values have been established for diameter series 7 and 8.
- 4) No values have been established for capped bearings.
- 5) It does not apply to bearings with flange.
- 6) It only applies to deep groove ball bearings.

Table 8.10 Radial Bearings (except taper roller bearings)

Tolerance class 2 Inner ring												μm		
d mm		Δ dmp		Δ ds		VDp ⁽²⁾	VDmp	K _{ia}	S _d	S _{ia} ⁽³⁾	Δ Bs			V _{Bs}
											All	Normal	Modified	
											high	low	max	
0.6 ¹⁾	2.5	0	-2.5	0	-2.5	2.5	1.5	1.5	1.5	1.5	0	-40	-250	1.5
2.5	10	0	-2.5	0	-2.5	2.5	1.5	1.5	1.5	1.5	0	-40	-250	1.5
10	18	0	-2.5	0	-2.5	2.5	1.5	1.5	1.5	1.5	0	-80	-250	1.5
18	30	0	-2.5	0	-2.5	2.5	1.5	2.5	1.5	2.5	0	-120	-250	1.5
30	50	0	-2.5	0	-2.5	2.5	1.5	2.5	1.5	2.5	0	-120	-250	1.5
50	80	0	-4	0	-4	4	2	2.5	1.5	2.5	0	-150	-250	1.5
80	120	0	-5	0	-5	5	2.5	2.5	2.5	2.5	0	-200	-380	2.5
120	150	0	-7	0	-7	7	3.5	2.5	2.5	2.5	0	-250	-380	2.5
150	180	0	-7	0	-7	7	3.5	5	4	5	0	-250	-380	4
180	250	0	-8	0	-8	8	4	5	5	5	0	-300	-500	5

- Note:
- 1) Including 0.6.
 - 2) It does not apply to diameter series 7,8 and 9.
 - 3) This only applies to deep groove ball bearings.
 - 4) This refers to the inner rings width deviation of single bearings made for paired or stack mounting.

Table 8.11 Radial Bearings (except tapered roller bearings)

Tolerance class 2 Outer ring													μm				
D mm		ΔD_{mp}		$\Delta D_s^{2)}$		$V_{dp}^{2)}$	V_{dmp}	K_{ea}	$S_{D^{2)}$	$S_{D1^{4)}$	$S_{ea^{3)4)}$	$S_{ea1^{4)}$	$\Delta C_s^{4)}$	$\Delta C_{1s}^{4)}$	$V_{cs}^{4)}$	$V_{c1s}^{4)}$	
over	incl	high	low	high	low	max	max	max	max	max	max	max	high	low	max		
2.5 ¹⁾	6	0	-2.5	0	-2.5	2.5	1.5	1.5	1.5	1.5	3				1.5		
6	18	0	-2.5	0	-2.5	2.5	1.5	1.5	1.5	1.5	3				1.5		
18	30	0	-4	0	-4	4	2	2.5	1.5	2.5	4				1.5		
30	50	0	-4	0	-4	4	2	2.5	1.5	2.5	4	Identical to ΔB_s and V_{Bs} of inner ring of same bearing			1.5		
50	80	0	-4	0	-4	4	2	4	1.5	4	6					1.5	
80	120	0	-5	0	-5	5	2.5	5	2.5	5	7					2.5	
120	150	0	-5	0	-5	5	2.5	5	2.5	5	7					2.5	
150	180	0	-7	0	-7	7	3.5	5	2.5	5	7					2.5	
180	250	0	-8	0	-8	8	4	7	4	7	10				4		
250	315	0	-8	0	-8	8	4	7	5	7	10				5		
315	400	0	-10	0	-10	10	5	8	7	8	11				7		

Note: The tolerances for the outside diameter of an outer ring flange are given in Table 8.20

- 1) Including 2.5.
- 2) Only applies to open bearings and close bearings with diameter series 0,1,2,3, and 4.
- 3) Not applies to outer ring flange bearings.
- 4) Only applies to deep groove ball bearings.

Table 8.12 Taper Roller Bearing

Tolerances class 0 Inner ring – Diameter tolerance and radial runout								μm	
d mm		Δd_{mp}		V_{dp}	V_{dmp}	K_{ia}			
over	incl	high	low	max	max	max	max	max	max
10	18	0	-12	12	9	15			
18	30	0	-12	12	9	18			
30	50	0	-12	12	9	20			
50	80	0	-15	15	11	25			
80	120	0	-20	20	15	30			
120	180	0	-25	25	19	35			
180	250	0	-30	30	23	50			
250	315	0	-35	35	26	60			
315	400	0	-40	40	30	70			

Table 8.13 Taper Roller Bearing

Tolerances Class 0 Outer ring – Diameter tolerance and radial runout								μm	
D mm		ΔD_{mp}		V_{Dp}	V_{Dmp}	K_{ea}			
over	incl	high	low	max	max	max	max	max	max
18	30	0	-12	12	9	18			
30	50	0	-14	14	11	20			
50	80	0	-16	16	12	25			
80	120	0	-18	18	14	35			
120	150	0	-20	20	15	40			
150	180	0	-25	25	19	45			
180	250	0	-30	30	23	50			
250	315	0	-35	35	26	60			
315	400	0	-40	40	30	70			
400	500	0	-45	45	34	80			
500	630	0	-50	50	38	100			

Note: The tolerances for the outside diameter D , of an outer ring flange are given in Table 8.20

Table 8.14 Taper Roller Bearing

Tolerance Class 0 Width – Inner and outer ring, single row bearing and their sub-units												μm	
d mm		ΔB_s		ΔC_s		ΔT_s		ΔT_{1s}		ΔT_{2s}			
over	incl	high	low	high	low	high	low	high	low	high	low	high	low
10	18	0	-120	0	-120	+200	0	+100	0	+100	0	+100	0
18	30	0	-120	0	-120	+200	0	+100	0	+100	0	+100	0
30	50	0	-120	0	-120	+200	0	+100	0	+100	0	+100	0
50	80	0	-150	0	-150	+200	0	+100	0	+100	0	+100	0
80	120	0	-200	0	-200	+200	-200	+100	-100	+100	-100	+100	-100
120	180	0	-250	0	-250	+350	-250	+250	-150	+200	-100	+200	-100
180	250	0	-300	0	-300	+350	-250	+150	-150	+200	-100	+200	-100
250	315	0	-350	0	-350	+350	-250	+150	-150	+200	-100	+200	-100
315	400	0	-400	0	-400	+400	-400	+200	-200	+200	-200	+200	-200

Table 8.15 Taper Roller Bearing

Tolerance Class 6X Width – Inner and outer ring, single row bearing and their sub-units												μm	
d mm		ΔB_s		ΔC_s		ΔT_s		ΔT_{1s}		ΔT_{2s}			
over	incl	high	low	high	low	high	low	high	low	high	low	high	low
10	18	0	-50	0	-100	+100	0	+50	0	+50	0	+50	0
18	30	0	-50	0	-100	+100	0	+50	0	+50	0	+50	0
30	50	0	-50	0	-100	+100	0	+50	0	+50	0	+50	0
50	80	0	-50	0	-100	+100	0	+50	0	+50	0	+50	0
80	120	0	-50	0	-100	+100	0	+50	0	+50	0	+50	0
120	180	0	-50	0	-100	+150	0	+50	0	+100	0	+100	0
180	250	0	-50	0	-100	+150	0	+50	0	+100	0	+100	0
250	315	0	-50	0	-100	+200	0	+100	0	+100	0	+100	0
315	400	0	-50	0	-100	+200	0	+100	0	+100	0	+100	0

Table 8.16 Taper Roller Bearing

Tolerances class 5 Inner ring and single row bearing width												μm	
d mm		Δd_{mp}		V_{dp}	V_{dmp}	K_{ia}	S_d	ΔB_s		ΔT_s			
over	incl	high	low	max	max	max	max	high	low	high	low	high	low
10	18	0	-7	5	5	5	7	0	-200	+200	-200	+200	-200
18	30	0	-8	6	5	5	8	0	-200	+200	-200	+200	-200
30	50	0	-10	8	5	6	8	0	-240	+200	-200	+200	-200
50	80	0	-12	9	6	7	8	0	-300	+200	-200	+200	-200
80	120	0	-15	11	8	8	9	0	-400	+200	-200	+200	-200
120	180	0	-18	14	9	11	10	0	-500	+350	-250	+350	-250
180	250	0	-22	17	11	13	11	0	-600	+350	-250	+350	-250

Table 8.17 Taper Roller Bearing

Tolerance Class 5 Outer ring μm

D mm		Δ Dmp		VDp	VDmp	Kea	SD ⁹ , SD1	Δ Cs	
over	incl	high	low	max	max	max	max	high	low
18	30	0	-8	6	5	6	8	Identical to ΔBs of inner ring of same bearing	
30	50	0	-9	7	5	7	8		
50	80	0	-11	8	6	8	8		
80	120	0	-13	10	7	10	9		
120	150	0	-15	11	8	11	10		
150	180	0	-18	14	9	13	10		
180	250	0	-20	15	10	15	11		
250	315	0	-25	19	13	18	13		
315	400	0	-28	22	14	20	13		

Note: The tolerances for the outside diameter D1 of an outer ring flange are given in Table 8.20
 1) Not apply to outer ring flange bearings.

Table 8.18 Taper Roller Bearing

Tolerances Class 4 Inner ring and single row bearing width μm

d mm		Δ dmp		Δ ds		Vdp	Vdmp	Kia	Sd	Sid	Δ Bs		Δ Ts	
over	incl	high	low	high	low	max	max	max	max	max	high	low	high	low
10	18	0	-5	0	-5	4	4	3	3	3	0	-200	+200	-200
18	30	0	-6	0	-6	5	4	3	4	4	0	-200	+200	-200
30	50	0	-8	0	-8	6	5	4	4	4	0	-240	+200	-200
50	80	0	-9	0	-9	7	5	4	5	4	0	-300	+200	-200
80	120	0	-10	0	-10	8	5	5	5	5	0	-400	+200	-200
120	180	0	-13	0	-13	10	7	6	6	7	0	-500	+350	-250
180	250	0	-15	0	-15	11	8	8	7	8	0	-600	+350	-250

Table 8.19 Taper Roller Bearing

Tolerance Class 4 Outer ring μm

D mm		Δ Dmp		Δ Ds		VDp	VDmp	Kea	SD ⁹ , SD1	Sea ⁹	Sea1	Δ Cs	
over	incl	high	low	high	low	max	max	max	max	max	max	high	low
18	30	0	-6	0	-6	5	4	4	4	5	7	Identical to ΔBs of inner ring of same bearing	
30	50	0	-7	0	-7	5	5	5	4	5	7		
50	80	0	-9	0	-9	7	5	5	4	5	7		
80	120	0	-10	0	-10	8	5	5	5	6	8		
120	150	0	-11	0	-11	8	6	6	5	7	10		
150	180	0	-13	0	-13	10	7	7	5	8	11		
180	250	0	-15	0	-15	11	8	10	7	10	14		
250	315	0	-18	0	-18	14	9	11	8	10	14		
315	400	0	-20	0	-20	15	10	13	10	13	18		

Note: The tolerances for the outside diameter D1 of an outer ring flange are given in Table 8.20
 1) Not apply to outer ring flange bearings.

Table 8.20 Radial Bearings with Flanged Outer Ring

Tolerance for flanged outer diameter μm

D1 mm		Δ D1s			
		Mounting Flange		Non-Mounting Flange	
over	incl	high	low	high	low
-	10	0	-36	+220	-36
10	18	0	-43	+270	-43
18	30	0	-52	+330	-52
30	50	0	-62	+390	-62
50	80	0	-74	+460	-74
80	120	0	-87	+540	-87
120	180	0	-100	+630	-100
180	250	0	-115	+720	-115
250	315	0	-130	+810	-130
315	400	0	-140	+890	-140
400	500	0	-155	+970	-155
500	630	0	-175	+1100	-175
630	800	0	-200	+1250	-200
800	1000	0	-230	+1400	-230
1000	1250	0	-260	+1650	-260
1250	1600	0	-310	+1950	-310
1600	2000	0	-370	+2300	-370
2000	2500	0	-440	+2800	-440

Tapered bore, taper 1:12 and 1:30 (Fig 8.4 and Fig 8.5)

Taper 1:12

Nominal half tapered angle

$$a = 2^\circ 23' 9.12'' = 2.38594^\circ = 0.041643 \text{ Radian}$$

Basic diameter of nominal bigger tapered bore

$$d_1 = d + \frac{1}{12} B$$

Taper 1:30

Nominal half tapered angle

$$a = 0^\circ 57' 17.4'' = 0.95484^\circ = 0.01667 \text{ Radian}$$

Basic diameter of nominal bigger tapered bore

$$d_1 = d + \frac{1}{30} B$$

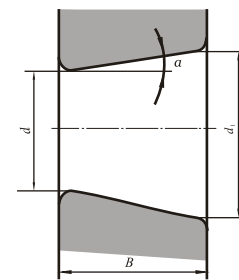

Fig 8.4 Nominal tapered bore

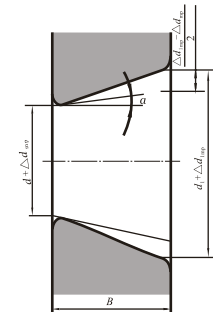

Fig 8.5 Tapered bore with actual diameters and their deviations

Table 8.21 Radial Bearings Tolerance Class 0 Tapered Bore(1:12)

d mm		Δd_{mp}		$\Delta d_{1mp} - \Delta d_{mp}$		$V_{dp}^{(1)(2)}$
over	incl	high	low	high	low	max
10	18	+22	0	+15	0	9
18	30	+27	0	+18	0	11
		+33	0	+21	0	13
30	50	+39	0	+25	0	16
50	80	+46	0	+30	0	19
80	120	+54	0	+35	0	22
120	180	+63	0	+40	0	40
180	250	+72	0	+46	0	46
250	315	+81	0	+52	0	52
315	400	+89	0	+57	0	57
400	500	+97	0	+63	0	63
500	630	+110	0	+70	0	70
630	800	+125	0	+80	0	-
800	1000	+140	0	+90	0	-
1000	1250	+165	0	+105	0	-
1250	1600	+195	0	+125	0	-

Note: 1) Apply to any single radial plane of inner bore.
2) Not apply to diameter series 7 and 8.

Table 8.22 Radial Bearings Tolerance Class 0 Tapered Bore(1:30)

d mm		Δd_{mp}		$\Delta d_{1mp} - \Delta d_{mp}$		$V_{dp}^{(1)(2)}$
over	incl	high	low	high	low	max
50	80	+15	0	+30	0	19
80	120	+20	0	+35	0	22
120	180	+25	0	+40	0	40
180	250	+30	0	+46	0	46
250	315	+35	0	+52	0	52
315	400	+40	0	+57	0	57
400	500	+45	0	+63	0	63
500	630	+50	0	+70	0	70

Note: 1) Apply to any radial plane of inner bore.
2) Not apply to diameter series 7 and 8.

Table 8.23 Thrust Bearings Tolerance Class 0 Shaft Washer and Bearing Height

d, dz / mm		$\Delta d_{mp}, \Delta d_{2mp}$		V_{dp}, V_{d2p}	S_i	ΔT_s		ΔT_{1s}	
over	incl	high	low	max	max	high	low	high	low
-	18	0	-8	6	0	+20	-250	+150	-400
18	30	0	-10	8	10	+20	-250	+150	-400
30	50	0	-12	9	10	+20	-250	+150	-400
50	80	0	-15	11	10	+20	-300	+150	-500
80	120	0	-20	15	15	+25	-300	+200	-500
120	180	0	-25	19	15	+25	-400	+200	-600
180	250	0	-30	23	20	+30	-400	+250	-600
250	315	0	-35	26	25	+40	-400	-	-
315	400	0	-40	30	30	+40	-500	-	-
400	500	0	-45	34	30	+50	-500	-	-
500	630	0	-50	38	35	+60	-600	-	-
630	800	0	-75	55	40	+70	-750	-	-
800	1000	0	-100	75	45	+80	-1000	-	-
1000	1250	0	-125	95	50	+100	-1400	-	-
1250	1600	0	-160	120	60	+120	-1600	-	-
1600	2000	0	-200	150	75	+140	-1900	-	-
2000	2500	0	-250	190	90	+160	-2300	-	-

Note: For double direction bearings, tolerance only applies to bearings $d_2 \leq 190$ mm.

Table 8.24 Thrust Bearings Tolerance Class 0 Housing Washer

D / mm		ΔD_{mp}		V_{Dp}	S_e
over	incl	high	low	max	max
10	18	0	-11	8	
18	30	0	-13	10	
30	50	0	-16	12	
50	80	0	-19	14	
80	120	0	-22	17	
120	180	0	-25	19	
180	250	0	-30	23	
250	315	0	-35	26	
315	400	0	-40	30	
400	500	0	-45	34	Equivalent to the value s_i of shaft washer of same bearing
500	630	0	-50	38	
630	800	0	-75	55	
800	1000	0	-100	75	
1000	1250	0	-125	95	
1250	1600	0	-160	120	
1600	2000	0	-200	150	
2000	2500	0	-250	190	
2500	2850	0	-300	225	

Note: For double direction bearings, tolerance only applies to bearings $D \leq 360$ mm.

Table 8.25 Thrust Bearings Tolerance Class 6 Shaft Washer and Bearing Height

d, d ₂ /mm		Δ d _{mp} , Δ d _{2mp}		V _{dP} , V _{d2P}	S _i	Δ T _s		Δ T _{1s}	
over	incl	high	low	max	max	high	low	high	low
-	18	0	-8	6	5	+20	-250	+150	-400
18	30	0	-10	8	5	+20	-250	+150	-400
30	50	0	-12	9	6	+20	-250	+150	-400
50	80	0	-15	11	7	+20	-300	+150	-500
80	120	0	-20	15	8	+25	-300	+200	-500
120	180	0	-25	19	9	+25	-400	+200	-600
180	250	0	-30	23	10	+30	-400	+250	-600
250	315	0	-35	26	13	+40	-400	-	-
315	400	0	-40	30	15	+40	-500	-	-
400	500	0	-45	34	18	+50	-500	-	-
500	630	0	-50	38	21	+60	-600	-	-
630	800	0	-75	55	25	+70	-750	-	-
800	1000	0	-100	75	30	+80	-1000	-	-
1000	1250	0	-125	95	35	+100	-1400	-	-
1250	1600	0	-160	120	40	+120	-1600	-	-
1600	2000	0	-200	150	45	+140	-1900	-	-
2000	2500	0	-250	190	50	+160	-2300	-	-

Note: For double direction bearings, tolerance only applies to bearings d₂≤190mm.

Table 8.26 Thrust Bearings Tolerance Class 6 Housing Washer

D/mm		Δ D _{mp}		V _{Dp}	S _e
over	incl	high	low	max	max
10	18	0	-11	8	
18	30	0	-13	10	
30	50	0	-16	12	
50	80	0	-19	14	
80	120	0	-22	17	
120	180	0	-25	19	
180	250	0	-30	23	
250	315	0	-35	26	
315	400	0	-40	30	
400	500	0	-45	34	Equivalent to the value s _i of shaft washer of same bearing
500	630	0	-50	38	
630	800	0	-75	55	
800	1000	0	-100	75	
1000	1250	0	-125	95	
1250	1600	0	-160	120	
1600	2000	0	-200	150	
2000	2500	0	-250	190	
2500	2850	0	-300	225	

Note: For double direction bearings, tolerance only applies to bearings D≤360mm.

Table 8.27 Thrust Bearings Tolerance Class 5 Shaft Washer and Bearing Height

d, d ₂ /mm		Δ d _{mp} , Δ d _{2mp}		V _{dP} , V _{d2P}	S _i	Δ T _s		Δ T _{1s}	
over	incl	high	low	max	max	high	low	high	low
18	30	0	-8	6	3	+20	-250	+150	-400
30	50	0	-12	9	3	+20	-250	+150	-400
50	80	0	-15	11	4	+20	-300	+150	-500
80	120	0	-20	15	4	+25	-300	+200	-500
120	180	0	-25	19	5	+25	-400	+200	-600
180	250	0	-30	23	5	+30	-400	+250	-600
250	315	0	-35	26	7	+40	-400	-	-
315	400	0	-40	30	7	+40	-500	-	-
400	500	0	-45	34	9	+50	-500	-	-
500	630	0	-50	38	11	+60	-600	-	-
630	800	0	-75	55	13	+70	-750	-	-
800	1000	0	-100	75	15	+80	-1000	-	-
1000	1250	0	-125	95	18	+100	-1400	-	-
1250	1600	0	-160	120	25	+120	-1600	-	-
1600	2000	0	-200	150	30	+140	-1900	-	-
2000	2500	0	-250	190	40	+160	-2300	-	-

Note: For double direction bearings, tolerance only applies to bearings d₂≤190mm.

Table 8.28 Thrust Bearings Tolerance Class 5 Housing Washer

D/mm		Δ D _{mp}		V _{Dp}	S _e
over	incl	high	low	max	max
10	18	0	-11	8	
18	30	0	-13	10	
30	50	0	-16	12	
50	80	0	-19	14	
80	120	0	-22	17	
120	180	0	-25	19	
180	250	0	-30	23	
250	315	0	-35	26	
315	400	0	-40	30	
400	500	0	-45	34	Equivalent to the value s _i of shaft washer of same bearing
500	630	0	-50	38	
630	800	0	-75	55	
800	1000	0	-100	75	
1000	1250	0	-125	95	
1250	1600	0	-160	120	
1600	2000	0	-200	150	
2000	2500	0	-250	190	
2500	2850	0	-300	225	

Note: For double direction bearings, tolerance only applies to bearings D≤360mm.

Table 8.29 Thrust Bearings Tolerance Class 4 Shaft Washer and Bearing Height

d, d ₂ /mm		Δ d _{mp} , Δ d _{2mp}		V _{dP} , V _{d2P}	S _i	Δ T _s		Δ T _{1s}	
over	incl	high	low	max	max	high	low	high	low
-	18	0	-7	5	2	+20	-250	+150	-400
18	30	0	-8	6	2	+20	-250	+150	-400
30	50	0	-10	8	2	+20	-250	+150	-400
50	80	0	-12	9	3	+20	-300	+150	-500
80	120	0	-15	11	3	+25	-300	+200	-500
120	180	0	-18	14	4	+25	-400	+200	-600
180	250	0	-22	17	4	+30	-400	+250	-600
250	315	0	-25	19	5	+40	-400	-	-
315	400	0	-30	23	5	+40	-500	-	-
400	500	0	-35	26	6	+50	-500	-	-
500	630	0	-40	30	7	+60	-600	-	-
630	800	0	-50	40	8	+70	-750	-	-

Note: For double direction bearings, tolerance only applies to bearings d₂ ≤ 190mm.

Table 8.30 Thrust Bearings Tolerance Class 4 Housing Washer

D/mm		Δ D _{mp}		V _{Dp}	S _e
over	incl	high	low	max	max
10	18	0	-7	5	
18	30	0	-8	6	
30	50	0	-9	7	
50	80	0	-11	8	
80	120	0	-13	10	
120	180	0	-15	11	
180	250	0	-20	15	Equivalent to the value of shaft washer of same bearing
250	315	0	-25	19	
315	400	0	-28	21	
400	500	0	-33	25	
500	630	0	-38	29	
630	800	0	-45	34	
800	1000	0	-60	45	

Note: For double direction bearings, tolerance only applies to bearings D ≤ 360mm.

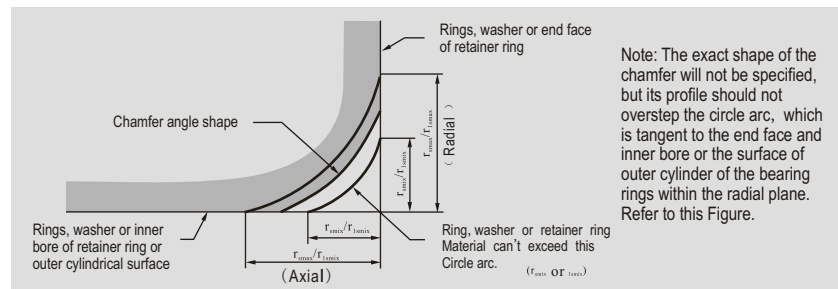

Fig 8.6

Table 8.31 The Maximum of Chamfer Dimension of Radial Bearing

r _{smin} ¹⁾	d		r _{smax} ²⁾	
	over	incl	radial	axial
0.05	-	-	0.1	0.2
0.08	-	-	0.16	0.3
0.1	-	-	0.2	0.4
0.15	-	-	0.3	0.6
0.2	-	-	0.5	0.8
0.3	-	-	0.6	1
	40	40	0.8	1
0.6	-	-	1	2
	40	-	1.3	2
1	-	-	1.5	3
	50	50	1.9	3
1.1	-	120	2	3.5
	120	-	2.5	4
1.5	-	120	2.3	4
	120	-	3	5
2	-	80	3	4.5
	80	220	3.5	5
	220	-	3.8	6
2.1	-	280	4	6.5
	280	-	4.5	7
2.5 ³⁾	-	100	3.8	6
	100	280	4.5	6
	280	-	5	7
3	-	280	5	8
	280	-	5.5	8
4	-	-	6.5	9
	-	-	8	10
	-	-	10	13
	-	-	12.5	17
	-	-	15	19
	-	-	18	24
	-	-	21	30
	-	-	25	38

- 1) The permissible maximum single chamfer dimension "r_{smax}" of shaft and outer bore should not be larger than the permissible minimum single chamfer dimension "r_{smin}" or "r_{ismin}" of the corresponding bearing ring or washer.
- 2) For the bearing whose width is less than 2mm, the radial value of r_{smax} is also suitable for axial.

Table 8.32 The Maximum Chamfer Dimensions of Cylindrical Roller Bearing Loose Rib, Thrust Collar and One Side Outer Ring with Snap Ring Groove.

mm

$r_{1smin}^{1)}$	d or D		$r_{1smax}^{2)}$	
	over	incl	radial	axial
0.2	-	-	0.5	0.5
0.3	-	40	0.6	0.8
	40	-	0.8	0.8
0.5	-	40	1	1.5
	40	-	1.3	1.5
0.6	-	40	1	1.5
	40	-	1.3	1.5
1	-	50	1.5	2.2
	50	-	1.9	2.2
1.1	-	120	2	2.7
	120	-	2.5	2.7
1.5	-	120	2.3	3.5
	120	-	3	3.5
2	-	80	3	4
	80	220	3.5	4
	220	-	3.8	4
2.1	-	280	4	4.5
	280	-	4.5	4.5
2.5 ²⁾	-	100	3.8	5
	100	280	4.5	5
	280	-	5	5
3	-	280	5	5.5
	280	-	5.5	5.5
4	-	-	6.5	6.5
5	-	-	8	8
6	-	-	10	10

1) The allowable maximum single chamfer dimension between shaft and housing r_{amax} should not be over the allowable minimum single chamfer dimension between the corresponding ring and washer r_{smin} or r_{tmin} .

Table 8.33 Maximum Chamfer Dimension of Inner and Outer Narrow End Faces of Cylindrical Roller Bearing and Outer Narrow End Faces of Angular Contact Ball Bearing

mm

$r_{1smin}^{1)}$	d or D		r_{1smax}	
	over	incl	radial	axial
0.1	-	-	0.2	0.4
0.15	-	-	0.3	0.6
	-	-	0.5	0.8
0.3	-	40	0.6	1
	40	-	0.8	1
0.6	-	40	1	2
	40	-	1.3	2
1	-	50	1.5	3
	50	-	1.9	3
1.1	-	120	2	3.5
	120	-	2.5	4
1.5	-	120	2.3	4
	120	-	3	5
2	-	80	3	4.5
	80	220	3.5	5
	220	-	3.8	6

1) The allowable maximum single chamfer dimension between shaft and housing r_{amax} should not be over the allowable minimum single chamfer dimension between the corresponding ring and washer r_{smin} or r_{tmin} .

Table 8.34 Maximum Chamfer Dimension of Taper Roller Bearings

mm

$r_{smin}^{1)}$	d or D		r_{smax}	
	over	incl	radial	axial
0.3	-	40	0.7	1.4
	40	-	0.9	1.6
0.6	-	40	1.1	1.7
	40	-	1.3	2
1	-	50	1.6	2.5
	50	-	1.9	3
1.5	-	120	2.3	3
	120	250	2.8	3.5
	250	-	3.5	4
2	-	120	2.8	4
	120	250	3.5	4.5
	250	-	4	5
2.5	-	120	3.5	5
	120	250	4	5.5
	250	-	4.5	6
3	-	120	4	5.5
	120	250	4.5	6.5
	250	400	5	7
4	-	120	5	7
	120	250	5.5	7.5
	250	400	6	8
5	-	180	6.5	8
	180	-	7.5	9
	-	180	7.5	10
6	-	180	9	11
	180	-	9	11

1) The allowable maximum single chamfer dimension between shaft and housing r_{amax} should not be over the allowable minimum single chamfer dimension between the corresponding ring and washer r_{smin} or r_{tmin} .

Table 8.35 Maximum Chamfer Dimension of Thrust Bearings mm

r _{smin} ¹⁾ Or r _{1smin} ¹⁾	r _{smax} Or r _{1smax}
	Radial and Axial
0.3	0.8
0.6	1.5
1	2.2
1.1	2.7
1.5	3.5
2	4
2.1	4.5
3	5.5
4	6.5
5	8
6	10
7.5	12.5
9.5	15
12	18
15	21
19	25

Note: The specified chamfer dimensions in this table are fit for:

- Bottom surface of housing washer and chamfer of outer cylindrical surface.
 - Shaft washer bottom surface and bore surface chamfer of single-way bearing.
 - Central washer end face and bore surface chamfer of double-way bearing.
- 1) The allowable maximum single chamfer dimension between shaft and housing r_{smax} should not be over the allowable minimum single chamfer dimension between the corresponding ring and washer r_{smin} or r_{1smin}.

In the actual application, bearing clearance is divided into original clearance, mounting clearance, working clearance, and decrease in turn.

Original clearance: clearance after the assembling of bearing;

Mounting clearance: clearance after the mounting of bearing;

Working clearance: clearance under actual working condition.

8.4.2 Function of Clearance

Bearing clearances have a relatively great influence on the bearing life, revolution precision, vibration, noise, temperature, friction resistance etc. The main function of clearance includes:

- Guarantee the flexibility of bearing revolution
- Adjust the space of bearing load
- Guarantee the bearing gets the correct contact angle (angular contact ball bearing)
- Reduce the friction between the parts
- Diminish or eliminate the influence for bearing running performance due to the dimension deviation resulted from the heat expansion, interference fit of parts
- Helpful for the form of lubricating oil film
- Convenience for the inspection of bearing precision

8.4.3 Selection of Clearance

In order to guarantee the good state of bearing running, it is necessary to choose suitable bearing clearance. To select bearing clearance should pay attention to several questions as below:

- The internal dimension alternation of bearing under interference fit
- The dimension variation resulted from the temperature alternation when the bearing is running
- The internal dimension deviation due to the different material expansion factors of axis or bearing blocks

In the actual operation, the general rules of selecting clearance are:

- The working clearance of ball bearing should be zero, or have slight preload
- Cylindrical roller bearing and spherical roller bearing must have certain working clearance
- Taper roller bearing should usually have certain clearance, but if there is requirement for bearing rigidity, should be imposed on certain preload

Theoretically, when bearing working clearance is slightly negative (with a certain preload), the fatigue life of bearing is the longest, refer to Fig. 8.8. But the ideal state is difficult to keep due to many non-predicative factors, it could have the possibility to realize after iterative practice and adjust. It shows in this fig, when the negative clearance of bearing becomes large further, the

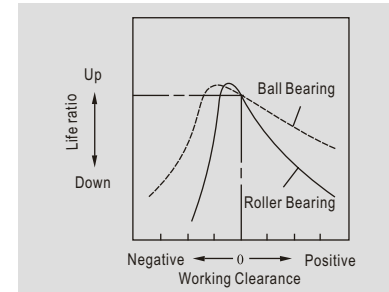

Fig 8.8

bearing fatigue life will obviously decline. This is a reliable method to select a larger working clearance value (over zero).

In GB/T4604<Rolling Bearing Radial Clearance>, the radial clearance of rolling bearing separately stipulated several different groups of clearance values according to the bearing structures to meet the selections of different customers. For example, the radial clearance of deep groove ball bearing is divided into C2, C0, C3, C4, C5 five clearance groups, in which C0 is the basic group, C2 is the smaller clearance group, C3, C4, C5 are the larger clearance groups.

The basic clearance group should be the priority selection for the bearings in normal working conditions. The basic clearance group should be the priority selection for the bearings in normal working conditions refer to:

- Inner ring rotating, inner ring and axis is assembled with interference fit
- The load of bearing $P \leq 0.1Cr$
- The speed of bearing is approximately less than 50% of its limiting speed
- Sufficient lubrication

For some bearings under the certain working condition, it should select different groups of bearing clearance according to their specific working condition. In order to lower the noise of motor bearings, the selected bearing clearance could be relatively smaller. In the situation of high rotating precision it should also select smaller clearance. However, the larger group of clearance should be selected for the high speed bearing or rolling mill bearings to reduce the rotating friction and lower the temperature of bearing. When the working temperature of bearing is higher, then a larger clearance should be selected.

Usually, this would mainly control the radial clearance of bearing, for three-point, four-point contact bearing and double-row, four-row taper roller bearing etc., it should control the axial

clearance of bearing during the process of production.

The original clearance of bearing was mostly "errored" due to the influence of the factor of heat during the assembling and working process etc., so the working clearance of bearing is usually smaller than original and assembling clearance.

Estimated according to the experience:

After assembling the bearing, the raceway of inner ring will expand due to the interference fit, the original clearance will reduce accordingly, the reduction is approximately 70%~80% of the interference fit value. In the same way, if the outer ring is interference fit, the raceway will reduce, the original clearance is also reduce.

During the rotating of bearing, the temperature difference will emerge between the inner ring and outer ring, the temperature of inner ring (inner ring rotating) is usually higher than that of outer ring (outer ring is static), the expansion of inner ring due to the heat will result in the reduction of clearance. The reduction could be estimated according to the following formula:

$$\Delta G_t \approx \alpha \cdot \Delta t \cdot F$$

where

ΔG_t — The reduction of radial clearance resulted from the heat difference between the two rings, mm

α — The linear expansion factor of bearing steel 12.5×10^{-6} , $1/^\circ\text{C}$

Δt — The temperature difference between inner and outer rings, $^\circ\text{C}$

F— The diameter of outer raceway, mm

The working clearance should be the difference value that the original clearance of bearing minus the above mentioned two reductions of the radial clearance.

8.4.4 Clearance Value

- The radial clearance of radial bearing refers to the table 8.36 ~ table 8.43.
- The axial clearance of the four-point contact ball bearing refers to the table 8.44.
- The radial clearance of double-row and four-row taper roller bearing refers to the table 8.4.

GB/T 4604-93

Table 8.36 Deep Groove Ball Bearings

μm

Nominal Inner Diameter d mm		Group 2		Group 0		Group 3		Group 4		Group 5	
over	incl	min	max	min	max	min	max	min	max	min	max
2.5	6	0	7	2	13	8	23	-	-	-	-
6	10	0	7	2	13	8	23	14	29	20	37
10	18	0	9	3	18	11	25	18	33	25	45
18	24	0	10	5	20	13	28	20	36	28	48
24	30	1	11	5	20	13	28	23	41	30	53
30	40	1	11	6	20	15	33	28	46	40	64
40	50	1	11	6	23	18	36	30	51	45	73
50	65	1	15	8	28	23	43	38	61	55	90
65	80	1	15	10	30	25	51	46	71	65	105
80	100	1	18	12	36	30	58	53	84	75	120
100	120	2	20	15	41	36	66	61	97	90	140
120	140	2	23	18	48	41	81	71	114	105	160
140	160	2	23	18	53	46	91	81	130	120	180
160	180	2	25	20	61	53	102	91	147	135	200
180	200	2	30	25	71	63	117	107	163	150	230
200	225	2	35	25	85	75	140	125	195	175	265
225	250	2	40	30	95	85	160	145	225	205	300
250	280	2	45	35	105	90	170	155	245	225	340
280	315	2	55	40	115	100	190	175	270	245	370
315	355	3	60	45	125	110	210	195	300	275	410
355	400	3	70	55	145	130	240	225	340	315	460
400	450	3	80	60	170	150	270	250	380	350	510
450	500	3	90	70	190	170	300	280	420	390	570
500	560	10	100	80	210	190	330	310	470	440	630
560	630	10	110	90	230	210	360	340	520	490	690
630	710	20	130	110	260	240	400	380	570	540	760
710	800	20	140	120	290	270	450	430	630	600	840
800	900	20	160	140	320	300	500	480	700	670	940
900	1000	20	170	150	350	330	550	530	770	740	1040
1000	1120	20	180	160	380	360	600	580	850	820	1150
1120	1250	20	190	170	410	390	650	630	920	890	1260

Table 8.37 Self-Aligning Ball Bearings with Cylindrical Bore

μm

Nominal Inner Diameter d mm		Group 2		Group 0		Group 3		Group 4		Group 5	
over	incl	min	max	min	max	min	max	min	max	min	max
2.5	6	1	8	5	15	10	20	15	25	21	33
6	10	2	9	6	17	12	25	19	33	27	42
10	14	2	10	6	19	13	26	21	35	30	48
14	18	3	12	8	21	15	28	23	37	32	50
18	24	4	14	10	23	17	30	25	39	34	52
24	30	5	16	11	24	19	35	29	46	40	58
30	40	6	18	13	29	23	40	34	53	46	66
40	50	6	19	14	31	25	44	37	57	50	71
50	65	7	21	16	36	30	50	45	69	62	88
65	80	8	24	18	40	35	60	54	83	76	108
80	100	9	27	22	48	42	70	64	96	89	124
100	120	10	31	25	56	50	83	75	114	105	145
120	140	10	38	30	68	60	100	90	135	125	175
140	160	15	44	35	80	70	120	110	161	150	210

Table 8.38 Self-Aligning Ball Bearings with Tapered Bore

μm

Nominal Inner Diameter d mm		Group 2		Group 0		Group 3		Group 4		Group 5	
over	incl	min	max	min	max	min	max	min	max	min	max
18	24	7	17	13	26	20	33	28	42	37	55
24	30	9	20	15	28	23	39	33	50	44	62
30	40	12	24	19	35	29	46	40	59	52	72
40	50	14	27	22	39	33	52	45	65	58	79
50	65	18	32	27	47	41	61	56	80	73	99
65	80	23	39	35	57	50	75	69	98	91	123
80	100	29	47	42	68	62	90	84	116	109	144
100	120	35	56	50	81	75	108	100	139	130	170
120	140	40	68	60	98	90	130	120	165	155	205
140	160	45	74	65	110	100	150	140	191	180	240

Table 8.39 Cylindrical Roller Bearings with Cylindrical Bore

μm

Nominal Inner Diameter d mm		Group 2		Group 0		Group 3		Group 4		Group 5	
over	incl	min	max	min	max	min	max	min	max	min	max
10	10	0	25	20	45	35	60	50	75	-	-
24	24	0	25	20	45	35	60	50	75	65	90
24	30	0	25	20	45	35	60	50	75	70	95
30	40	5	30	25	50	45	70	60	85	80	105
40	50	5	35	30	60	50	80	70	100	95	125
50	65	10	40	40	70	60	90	80	110	110	140
65	80	10	45	40	75	65	100	90	125	130	165
80	100	15	50	50	85	75	110	105	140	155	190
100	120	15	55	50	90	85	125	125	165	180	220
120	140	15	60	60	105	100	145	145	190	200	245
140	160	20	70	70	120	115	165	165	215	225	275
160	180	25	75	75	125	120	170	170	220	250	300
180	200	35	90	90	145	140	195	195	250	275	330
200	225	45	105	105	165	160	220	220	280	305	365
225	250	45	110	110	175	170	235	230	300	330	395
250	280	55	125	125	195	190	260	260	330	370	440
280	315	55	130	130	205	200	275	275	350	410	485
315	355	65	145	145	225	225	305	305	385	455	535
355	400	100	190	190	280	280	370	370	460	510	600
400	450	110	210	210	310	310	410	410	510	565	665
455	500	110	220	220	330	330	440	440	550	625	735

Note: Radial internal clearance in needle roller bearings

Needle roller bearings with inner ring, outer ring and cage take the radial internal clearance shown in Table 8.39, except the outer-ring-punched needle roller bearings and the heavy series ones.

The radial internal clearance in needle roller bearings, which are delivered with inner rings as separate parts and belong to heavy series needle roller bearings with inner ring and outer ring (refer to GB4603), is decided by the diameter of inner ring raceway and needle roller parts. The tolerance of the diameter is defined in GB4603 and GB5801.

Table 8.40 Self-Aligning Roller Bearings with Cylindrical Bore μm

Nominal Inner Diameter d mm		Group 2		Group 0		Group 3		Group 4		Group 5	
over	incl	min	max	min	max	min	max	min	max	min	max
14	18	10	20	20	35	35	45	45	60	60	75
18	24	10	20	20	35	35	45	45	60	60	75
24	30	15	25	25	40	40	55	55	75	75	95
30	40	15	30	30	45	45	60	60	80	80	100
40	50	20	35	35	55	55	75	75	100	100	125
50	65	20	40	40	65	65	90	90	120	120	150
65	80	30	50	50	80	80	110	110	145	145	180
80	100	35	60	60	100	100	135	135	180	180	225
100	120	40	75	75	120	120	160	160	210	210	260
120	140	50	95	95	145	145	190	190	240	240	300
140	160	60	110	110	170	170	220	220	280	280	350
160	180	65	120	120	180	180	240	240	310	310	390
180	200	70	130	130	200	200	260	260	340	340	430
200	225	80	140	140	220	220	290	290	380	380	470
225	250	90	150	150	240	240	320	320	420	420	520
250	280	100	170	170	260	260	350	350	460	460	570
280	315	110	190	190	280	280	370	370	500	500	630
315	355	120	200	200	310	310	410	410	550	550	690
355	400	130	220	220	340	340	450	450	600	600	750
400	450	140	240	240	370	370	500	500	660	660	820
450	500	140	260	260	410	410	550	550	720	720	900
500	560	150	280	280	440	440	600	600	780	780	1000
560	630	170	310	310	480	480	650	650	850	850	1100
630	710	190	350	350	530	530	700	700	920	920	1190
710	800	210	390	390	580	580	770	770	1010	1010	1300
800	900	230	430	430	650	650	860	860	1120	1120	1440
900	1000	260	480	480	710	710	930	930	1220	1220	1570

Table 8.41 Self-Aligning Roller Bearings with Tapered Bore μm

Nominal Inner Diameter d mm		Group 2		Group 0		Group 3		Group 4		Group 5	
over	incl	min	max	min	max	min	max	min	max	min	max
18	24	15	25	25	35	35	45	45	60	60	75
24	30	20	30	30	40	40	55	55	75	75	95
30	40	25	35	35	50	50	65	65	85	85	105
40	50	30	45	45	60	60	80	80	100	100	130
50	65	40	55	55	75	75	95	95	120	120	160
65	80	50	70	70	95	95	120	120	150	150	200
80	100	55	80	80	110	110	140	140	180	180	230
100	120	65	100	100	135	135	170	170	220	220	280
120	140	80	120	120	160	160	200	200	260	260	330
140	160	90	130	130	180	180	230	230	300	300	380
160	180	100	140	140	200	200	260	260	340	340	430
180	200	110	160	160	220	220	290	290	370	370	470
200	225	120	180	180	250	250	320	320	410	410	520
225	250	140	200	200	270	270	350	350	450	450	570
250	280	150	220	220	300	300	390	390	490	490	620
280	315	170	240	240	330	330	430	430	540	540	680
315	355	190	270	270	360	360	470	470	590	590	740
355	400	210	300	300	400	400	520	520	650	650	820
400	450	230	330	330	440	440	570	570	720	720	910
450	500	260	370	370	490	490	630	630	790	790	1000
500	560	290	410	410	540	540	580	580	870	870	1100
560	630	320	460	460	600	600	760	760	980	980	1230
630	710	350	510	510	670	670	850	850	1090	1090	1360
710	800	390	570	570	750	750	960	960	1220	1220	1500
800	900	440	640	640	840	840	1070	1070	1370	1370	1690
900	1000	490	710	710	930	930	1190	1190	1520	1520	1860

Table 8.42 Recommended Radial Internal Clearance in Double Row Cylindrical Roller Bearings with Tapered Bore μm

Nominal Inner Diameter d mm		Group 1		Group 2	
over	incl	min	max	min	max
24	24	10	20	20	30
30	30	15	25	25	35
40	40	15	25	25	40
50	50	17	30	30	45
65	65	20	35	35	5
80	80	25	40	40	60
100	100	35	55	45	70
120	120	40	60	50	80
140	140	45	70	60	90
160	160	50	75	65	100
180	180	55	85	75	110
200	200	60	90	80	120
225	225	60	95	90	135
250	250	65	100	100	150
280	280	75	110	110	165
315	315	80	120	120	180
355	355	90	135	135	200
400	400	100	150	150	225
450	450	110	170	170	255
500	500	120	190	190	285

Table 8.43 Recommended Radial Internal Clearance in Double Row Cylindrical Roller Bearings with Cylindrical Bore

Nominal Inner Diameter d mm		μm					
		Group 1		Group 2		Group 3	
over	incl	min	max	min	max	min	max
24	24	5	15	10	20	20	30
24	30	5	15	10	25	25	35
30	40	5	15	12	25	25	40
40	50	5	18	15	30	30	45
50	65	5	20	15	35	35	50
65	80	10	25	20	40	40	60
80	100	10	30	25	45	45	70
100	120	10	30	25	50	50	80
120	140	10	35	30	60	60	90
140	160	10	35	35	65	65	100
160	180	10	40	35	75	75	110
180	200	15	45	40	80	80	120
200	225	15	50	45	90	90	135
225	250	15	50	50	100	100	150
250	280	20	55	55	110	110	165
280	315	20	60	60	120	120	180
315	355	20	65	65	135	135	200
355	400	25	75	75	150	150	225
400	450	25	85	85	170	170	255
450	500	25	95	95	190	190	285

Table 8.44 Axial Internal Clearance in Four-Point Contact Ball Bearings

Nominal Inner Diameter d mm		μm							
		Group 2		Group 0		Group 3		Group 4	
over	incl	min	max	min	max	min	max	min	max
10	18	15	55	45	85	75	115	105	145
18	40	26	66	56	106	96	146	136	186
40	60	36	86	76	126	116	166	156	206
60	80	46	96	86	136	126	176	166	216
80	100	56	116	96	156	136	196	176	236
100	140	66	136	116	176	156	216	196	256
140	180	76	156	136	196	176	236	216	276
180	220	96	176	156	216	196	256	236	296
220	260	115	195	175	235	215	295	275	335
260	300	135	215	195	275	255	335	295	355

Table 8.45 Radial Internal Clearance in Double Row and Four-row Taper Roller Bearings

Nominal Inner Diameter d mm		μm											
		Group 1		Group 2		Group 0		Group 3		Group 4		Group 5	
over	incl	min	max	min	max	min	max	min	max	min	max	min	max
30	30	0	10	10	20	20	30	40	50	50	60	70	80
30	40	0	12	12	25	25	40	45	60	60	75	80	95
40	50	0	15	15	30	30	45	50	65	65	80	90	110
50	65	0	15	15	30	30	50	50	70	70	90	90	120
65	80	0	20	20	40	40	60	60	80	80	110	110	150
80	100	0	20	20	45	45	70	70	100	100	130	130	170
100	120	0	25	25	50	50	80	80	110	110	150	150	200
120	140	0	30	30	60	60	90	90	120	120	170	170	230
140	160	0	30	30	65	65	100	100	140	140	190	190	260
160	180	0	35	35	70	70	110	110	150	150	210	210	280
180	200	0	40	40	80	80	120	120	170	170	230	230	310
200	225	0	40	40	90	90	140	140	190	190	260	260	340
225	250	0	50	50	100	100	150	150	210	210	290	290	380
250	280	0	50	50	110	110	170	170	230	230	320	320	420
280	315	0	60	60	120	120	180	180	250	250	350	350	460
315	355	0	70	70	140	140	210	210	280	280	390	390	510
355	400	0	70	70	150	150	230	230	310	310	440	440	580
400	450	0	80	80	170	170	260	260	350	350	490	490	650
450	500	0	90	90	190	190	290	290	390	390	540	540	720
500	560	0	100	100	210	210	320	320	430	430	590	590	790
560	630	0	110	110	230	230	350	350	480	480	660	660	880
630	710	0	130	130	260	260	400	400	540	540	740	740	910
710	800	0	140	140	290	290	450	450	610	610	830	830	1100
800	900	0	160	160	330	330	500	500	670	670	920	920	1240
900	1000	0	180	180	360	360	540	540	720	720	980	980	1300
1000	1120	0	200	200	400	400	600	600	820	-	-	-	-
1120	1250	0	220	220	450	450	670	670	900	-	-	-	-
1250	1400	0	250	250	500	500	750	750	980	-	-	-	-

Note: Radial clearance is converted into approximate value of axial clearance ($G_a = G \cdot r^{1.5} / e$ or $G_a = Cr \cdot \cot a$;
 G_a =axial internal clearance; G_r =radial internal clearance; factor e is given in bearing dimension tables;
 a =angle of outer raceway).

9. Bearing Application

9.1 Fits

There must be even supports on the whole circle surface of the inner and outer diameters as the basis to make the bearing give full play of its load capacity.

The assembly of the shaft with a certain basic dimension and the bore with the same basic dimension is called fit. The fit of rolling bearing is the fits of the inner ring with a shaft, outer ring with housing, that is the radial location of bearings.

Bearing fits are usually taken two ways: interference fits and clearance fits. Interference fit is applied more between rotating parts, such as the fits of inner bore with the shaft. Clearance fits are generally applied between static parts, such as the fits of outer ring with housing. Insufficient fit interference can lead to sliding between the bearing with shaft or housing bore,

once sliding appears, it will result in abrasion and make the surface precision of shaft or housing slide destroyed. If particulates caused by abrasion slide into the bearing, it will influence the bearings application performance. Serious sliding will also cause high temperature and make bearing failure premature.

However, the exceeding interference fit will result in the pulling stress on the inner raceway surface and affect the fatigue life of bearing.

9.1.1 Selection of Fits

9.1.1.1 Principle of Selecting Fits

- There must be good support on the surface of inner, outer diameter and end faces. Good support should play an effect of shaft supporting.
- Bearing rings under "rotating load" could not slide along the circumference direction.

However, bearing rings under fixed load are permitted to have slight circumference sliding to slowly change its load area, which, make the raceway carry equal loads on the circumference direction.

- If a non-separable bearing is adopted at the wandering end, then the axial move may be allowed. So the small clearance fits may be considered.

When selecting interference fits, it should not be too large, interference should be reduced under the precondition of no-sliding. Excessive interference will reduce clearance and make the inner raceway surface have a pulling stress, which, influences the normal application and life of bearings.

- The bearings are precision parts with thin-section. After fitting, the geometry precession of shaft or housing would be reflected on bearings. This must require the parts installed have suitable precision so that can match with the bearings.
- It should be considered the convenience of mounting and dismounting when choosing fits. Excessive interference fit is uneasy to mount and dismount and it is easy to damage the bearing when mounting and dismounting.

It is difficult to meet all the above mentioned requirements due to their contradiction when selecting bearing fits. In actual selection it is enough to seize the main factor according to specific application.

9.1.1.2 Selection of Fits

To select proper fits, we should consider the bearing structures, loads, temperatures, precision, material of shaft and housing, processing precision, thickness, stress, mounting and dismounting methods should be considered.

• The Characteristic and Magnitude of Bearing Loads and Fits





The characteristic of bearings mainly refers to the acting direction of loads and its variation and with vibratory shock or not. Rotation or static of the load acting direction towards bearing inner ring or outer ring is the basic requirement to assure the fits of bearing with shaft and housing.

If one load acting direction towards a certain ring is rotation, the load towards the ring is called "rotating load". For example, when there is a load with fixed direction acted on the bearing, whose inner ring is rotating and outer ring is static, so the load towards inner ring is "rotating load", and "static load" toward outer ring.

If one load acting direction towards a certain ring is static, the load towards the ring is called "static load". For example, when there is a load with fixed direction acted on the bearing, whose inner ring is static and outer ring is rotating, so the load towards inner ring is "static load", and "rotating load" toward outer ring.

The relation of several load characteristics and fit methods is shown in Table 9.1.

Table 9.1

Condition of rotation and load Condition of Movement	Sketch	Load	Application	Fits way by suggested
Inner ring rotating Outer ring static		Inner ring rotating load Outer ring static load Condition of constant load	Shaft driven by belt	Inner ring interference fits Outer ring clearance fits
Inner ring static Outer ring rotating		Inner ring static load Outer ring rotating load Direction of constant load	Roller of transport tape vehicle hub bearing	Inner ring clearance fits Outer ring interference fits
Inner ring rotating Outer ring static		Inner ring static load Outer ring rotating load Load along with inner ring running	Vibration machine Riddler	Outer ring interference fits Inner ring clearance fits
Inner ring static Outer ring rotation		Inner ring rotating load Outer ring static load Load along with outer ring running	Slewing crusher Whirligig drive	Inner ring interference fits Outer ring clearance fits

In general:

- Bearing ring carrying "rotating load" should adopt interference fits
- Bearing ring carrying "static load" should adopt small clearance fits and small interference fits
- Bearing ring carrying impact and vibration load should adopt interference fits

To those which should adopt interference fits but have to adopt clearance fits for some limitations of working condition. The lubrication of the fitting surface should be done.

Load acted on rolling bearing will make the fit surface partially deformed, which, will lead to effective interference reduce or loose and generate an abrasion by pressure. In general, the load is heavier, the fit is tighter. The magnitude of load may use the ratio of load (equivalent dynamic load P to the basic rating C) as reference, and their relations are shown in Table 9.2

Table 9.2

Magnitude of load	P/C
Light load	<0.07
Normal load	>0.07~0.15
Heavy load	>0.15

The reduction of interference caused by load can be estimated as follows:

$$Fr \leq 0.3C_0 \quad \Delta d_f = 0.08 \sqrt{\frac{d}{B}} Fr$$

$$Fr > 0.3C_0 \quad \Delta d_f = 0.2 \frac{Fr}{B}$$

where:

Δd_f - the reduction of interference caused by radial load, μm

d - Inner diameter, mm

B - Width, mm

Fr - Radial load, N

C₀ - Basic static load rating, N

The fit ways are selected based on the characteristic and magnitude of load:

- Fits of radial bearing with shaft and the code of shaft tolerance zone, see Table 9.3
- Fits of radial bearing with shell and the code of bore tolerance zone, see Table 9.4
- Fits of thrust bearing with shaft and the code of shaft tolerance zone, see Table 9.5
- Fits of thrust bearing with housing and the code of bore tolerance zone, see Table 9.6
- Fits of radial bearing with shaft and shell (except taper roller bearing), see Table 9.7~

9.10

- Fits of taper roller bearing with shaft and housing, see Table 9.11~9.12

• Working Temperatures and Fits

When bearing is running without the influence of outer heat source, its working temperature is usually higher than the adjacent parts by reason of the abrasion, which will affect the tightness degree of fits. The fits of inner ring with shaft probably become loose by reason of thermal expansion, and the interference is increased or reduced between outer ring and housing by reason of the difference of temperature and the difference of material linear expansion coefficient even under the high temperature working conditions. In general, if the difference of temperature between bearing itself and its surrounding environment is ΔT (°C), and then, the temperature of inner ring is higher than the shaft about $(0.1 \sim 0.15) \Delta T$, the reduction Δd_r of inner ring caused by the temperature difference of inner ring with shaft can be estimated as following:

$$\Delta d_r = (0.1 \sim 0.15) \Delta T \cdot \alpha \cdot d$$

where:

α - Linear expansion coefficient. Linear expansion coefficient of bearing steel is $12.5 \times 10^{-6} / ^\circ C$

d - Inner diameter, mm

While selecting the proper fits, if the housing elevates to a higher temperature than the bearing, the fit of outer ring and housing bore should be tight; if not, the fit should be loose. If the shaft gets a higher temperature than the bearing, the fit of inner ring and shaft should be loose; if not, the fit should be tight.

• Roughness and Interference of the Fitting Surface

If the fitting surface of shaft is rough, the housing bore will be trowelled when the bearing is fixed, as a result, the actual effective interference fit will be smaller than theoretically calculated or actually measured. The actual effective interference fit can be estimated as follows:

$$\text{Grinding shafts} \quad \Delta d' = \frac{d}{d+2} \Delta d$$

$$\text{Lathy shafts} \quad \Delta d' = \frac{d}{d+3} \Delta d$$

where:

$\Delta d'$ - Effective interference fit, mm

Δd - Theoretically calculated interference fit, mm

d - Inside diameter of bearing, mm

• Inner Stress of Bearing Rings Caused by Fits

When the fit of bearings is tight, the internal stress will emerge on the outer ring raceway because of shrinking, the tensile stress will emerge on the inner ring because of expansion. From the point of a crack expansion, the internal stress can slow down the speed of crack expansion, and the tensile stress can speed up it. Therefore, when adopting interference fit, the interference should be under control, especially for the interference fit of inner ring and shaft which should be less than 1/1000 of the inside diameter.

• Supports and Fits

Bearings having thin-section components must be designed to have enough supporting surface and rigid. When bearings are fixed on the easy-deformation thin-section housing bores, light metal housing bores or hollow shafts, the fits should be tighter than on the cylindrical roller bearings without flanges, the fit of inner (outer) ring and shaft (housing) can be interference fit when the moving distance is short.

Because the split bearing housings have a comparatively bad accuracy which may cause elliptic outer rings or deformation, we should try not to use this structure. If we have to, we should choose small interference fit or clearance fit to keep bearings from extruded deformation.

• Assembling and Disassembling Fits

For clearance fits, the methods and instruments to assemble and disassemble bearings are easy to apply. For interference fits, we must think about methods and instruments to assemble and disassemble bearings. If the bearings need to be assembled and disassembled frequently, loose fits or clearance fits should be chosen. If the bearings have long lives and don't need to be assembled and disassembled frequently, tight fits should be chosen.

• Fits of Bearings with Tapered Bores

Bearings with tapered bores usually require tight fits. The fits are determined not by journal tolerance, but by axial distance of bearings being pushed into tapered contact surface. When bearings are pushed into tapered journal, the journal force on the inner rings to expand constantly, the expansion of inner rings reduces the radial clearance of bearings. Therefore, interference fits can be controlled by clearance

reduction while assembling. For solid axis of 1:12 taper, normal bearings' axial distance on the radial direction is about 15 times the reduction of radial clearance, and the reduction of radial clearance is about 0.8 times of the interference fit.

The advantages of adaptor sleeve and withdraw sleeve are easy of assembly and disassembly, and low requests for journal tolerance and surface roughness. Adaptor sleeve is flexible and can fit shafts deformation, but the journal tolerance must be controlled. This kind of fit is only suitable for occasions requesting low running accuracy.

• Requests for Accuracy and Chamfer of Fitting Surface

Bearings belong to thin-section components. When interference fit is needed, the geometry form discrepancy of the journal and housing bore will directly affect the geometry size and running accuracy of the components. For example, the shaft shoulder and the housing bore supporters are the setting faces of the bearings' axial positions, and if their end faces run out, the bearing's assembly will appear deviated. The roundness and cylindricity errors of journal surface will affect the raceway of inner ring, and result in vibration and local force. Therefore, requests must be taken for the geometry form accuracy of the journal surface and the housing bore, especially for the precision bearings(see Table 9.1). Or else, even the precision bearings can not perform to their original accuracy.

Table 9.3 Fits of Radial Bearings with Shaft Code of Shaft Tolerance Zone

Bearings with Cylindrical Bore						
Conditions of Rotation		Conditions of Loads	Deep Groove Ball Bearings, Self-Aligning Ball Bearings, Angular Contact Ball Bearings	Cylindrical Roller Bearings, Taper Roller Bearings	Self-Aligning Roller Bearings	Tolerance Zones
Condition	Examples	Nominal Bore Diameter mm				
Inner ring is rotating or oscillating	Machineries, motors, machine tool spindles, turbines, gear boxes, pumps, engines, Axial boxes of railway vehicles, crushers	Light loads	≤18 >18~100 >100~200 —	— ≤40 >40~140 >140~200	— ≤40 >40~100 >100~200	h5 j6 ¹⁾ k6 ¹⁾ m6 ¹⁾
		Normal loads	≤18 >18~100 >100~140 >140~200 >200~280 — —	— ≤40 >40~100 >100~140 >140~200 >200~400 —	— ≤40 >40~65 >65~100 >100~140 >140~280 >280~500	j5 js5 k5 ²⁾ m5 ²⁾ m6 n6 p6 r6
		Heavy loads	— — —	— — —	>50~140 >140~200 >200 —	>50~100 >100~140 >140~200 >200
Inner ring is stationary	All wheels on the stationary shaft, tensioner, riddler, inertial vibrator	All	All			f6 ¹⁾ g6 h6 j7
Axial loads only		All				j6、js6
Bearings with Tapered Bore						
All	Axile boxes of railway vehicles	All diameters mounted on the with drawal sleeve				h8(IT6) ⁵⁾
	General mechanical transmission	All diameters mounted on the with drawal sleeve				h9(IT7) ⁵⁾

- Note: 1) For bearings of higher accuracy, please use j5, k5...instead of j6, k6 etc.
 2) Single row tapered roller bearings and single row angular contact ball bearings can Use K6, m6 instead of k5, m5, because the effect of internal clearance is not significant.
 3) Bearing clearance should select greater than group 0 under heavy loads.
 4) For bearings of higher accuracy and higher speed rotation, please select h7(IT5)instead of h8(IT6).
 5) IT6 and IT7 stand for the cylindricity tolerance.

Table 9.4 Fits of Radial Bearings with Housing Code of Bore Tolerance

Conditions of Rotation		Conditions of Loads	Other Conditions	Tolerance Zone ¹⁾	
Condition	Examples			Ball Bearings	Roller Bearings
Outer ring is stationary	Machineries, axle boxes of railway vehicles, motors, pumps, etc	Light, normal	Select the split housing when easily moving in the axial direction	H7、G7 ²⁾	
Outer ring is oscillating		Punch	Select one-piece or split housing when could move in the axial direction	J7、Js7	
		Light, normal	Select one-piece housings when no moving in the axial direction	K7	
		Normal, heavy		M7	
Outer ring is rotating	Tensioners, pulleys	Punch		J7	K7
		Light		K7、M7	M7、N7
		Normal		—	N7、P7
		Heavy			

Note: 1) Tolerance zones are chosen from left to right with the growth of size. For bearings of higher accuracy, tolerance can be raised by one level.

2) Not suitable for split housing.

Table 9.5 Fits of Thrust Bearings with Shaft Code of Shaft Tolerance Zone

Conditions of Rotation	Conditions of Loads	Thrust Ball and Roller Bearings	Thrust Self-aligning Roller Bearings	Tolerance Zone
		Nominal Bore Diameter mm		
Axial loads only		All the sizes		j6、js6
Shaft washer is stationary	Combined loads of radial and axial	—	≤250	j6
		—	>250	js6
Shaft washer is Rotating or oscillating		—	≤200	k6 ¹⁾
		—	>200~400	m6
		—	>400	n6

Note: 1) For bearings of small interference, please use j6, k6, m6 instead of k6, m6, n6.

2) Also including tapered roller thrust bearings and angular contact thrust ball Bearings.

Table 9.6 Fits of Thrust Bearings and Outer Housing Tolerance Zones for The Housing Bore

Condition of Rotation	Condition of Loads	Bearing Types	Tolerances	Remarks
Axial loads only		Thrust ball bearings	H8	
		Cylindrical and taper roller thrust bearings	H7	
		Self-aligning roller thrust bearings		The clearance between outer bore and housing is 0.001D (D is nominal outside diameter)
Housing washer is stationary	Combined loads of radial and axial	Angular contact thrust ball bearings Self-aligning roller thrust bearings Taper roller thrust bearings	H7	Common condition
Housing washer is rotating or oscillating			K7	Under heavy radial loads
			M7	

Table 9.7 The Fits between Radial Bearing and Shaft (except taper roller bearing), Class P0

Normal Dimensions mm		Inner Diameters Δ_{dmp}		Tolerance Zones for Shafts											
				g6	g5	h6	h5	j5	j6						
over	include	high	low	Limiting Deviation of Journal Diameter											
3	6	0	-8	-4	-12	-4	-9	0	-8	0	-5	+3	-2	+6	-2
6	10	0	-8	-5	-14	-5	-11	0	-9	0	-6	+4	-2	+7	-2
10	180	0	-8	-6	-17	-6	-14	0	-11	0	-8	+5	-3	+8	-3
18	30	0	-10	-7	-20	-7	-16	0	-13	0	-9	+5	-4	+9	-4
30	50	0	-12	-9	-25	-9	-20	0	-16	0	-11	+6	-5	+11	-5
50	80	0	-15	-10	-29	-10	-23	0	-19	0	-13	+6	-7	+12	-7
80	120	0	-20	-12	-34	-12	-27	0	-22	0	-15	+6	-9	+13	-9
120	140														
140	160	0	-25	-14	-39	-14	-32	0	-25	0	-18	+7	-11	+14	-11
160	180														
180	200														
200	225	0	-30	-15	-44	-15	-35	0	-29	0	-20	+7	-13	+16	-13
225	250														
250	280	0	-35	-17	-49	-17	-40	0	-32	0	-23	+7	-16	-	-
280	315														
315	355	0	-40	-18	-54	-18	-43	0	-36	0	-25	+7	-18	-	-
355	400														
400	450	0	-45	-20	-60	-20	-47	0	-40	0	-27	+7	-20	-	-
450	500														
Normal Dimensions mm		Clearance(C) or Interference(I)													
over	include	max (c)	max (i)	max (c)	max (i)	max (c)	max (i)	max (c)	max (i)	max (c)	max (i)	max (c)	max (i)	max (c)	max (i)
3	6	12	4	9	4	8	8	5	8	2	11	2	14		
6	10	14	3	11	3	9	8	6	8	2	12	2	15		
10	18	17	2	14	2	11	8	8	8	3	13	3	16		
18	30	20	3	16	3	13	10	9	10	4	15	4	19		
30	50	25	3	20	3	16	12	11	12	5	18	5	23		
50	80	29	5	23	5	19	15	13	15	7	21	7	27		
80	120	34	8	27	8	22	20	15	20	9	26	9	33		
120	140														
140	160	39	11	32	11	25	25	18	25	11	32	11	39		
160	180														
180	200														
200	225	44	15	35	15	29	30	20	30	13	37	13	46		
225	250														
250	280	49	18	40	18	32	35	23	35	16	42	-	-		
280	315														
315	355	54	22	43	22	36	40	25	40	18	47	-	-		
355	400														
400	450	60	25	47	25	40	45	27	45	20	52	-	-		
450	500														

Normal Dimensions mm		Tolerance Zones for Shafts																	
		js6	k5	k6	m5	m6	n6	p6	r6	r7									
over	include	Limiting Deviation of Journal Diameter																	
+4	-4	+6	+1	+9	+1	+9	+4	+12	+4	+16	+8	+20	+12	-	-	-	-		
+4.5	-4.5	+7	+1	+10	+1	+12	+6	+15	+6	+19	+10	+24	+15	-	-	-	-		
+5.5	-5.5	+9	+1	+12	+1	+15	+7	+18	+7	+23	+12	+29	+18	-	-	-	-		
+6.5	-6.5	+11	+2	+15	+2	+17	+8	+21	+8	+28	+15	+35	+22	-	-	-	-		
+8	-8	+13	+2	+18	+2	+20	+9	+25	+9	+33	+17	+42	+26	-	-	-	-		
+9.5	-9.5	+15	+2	+21	+2	+24	+11	+30	+11	+39	+20	+51	+32	-	-	-	-		
+11	-11	+18	+3	+25	+3	+28	+13	+35	+13	+45	+23	+59	+37	-	-	-	-		
+12.5	-12.5	+21	+3	+28	+3	+33	+15	+40	+15	+52	+27	+68	+43	+88	+63	-	-		
+14.5	-14.5	+24	+4	+33	+4	+37	+17	+46	+17	+60	+31	+79	+50	+90	+65	+106	+77		
+16	-16	+27	+4	+36	+4	+43	+20	+52	+20	+66	+34	+88	+56	+109	+80	+113	+84		
+18	-18	+29	+4	+40	+4	+46	+21	+57	+21	+73	+37	+98	+62	+126	+94	+130	+84		
+20	-20	+32	+5	+45	+5	+50	+23	+63	+23	+80	+40	+108	+68	+144	+108	+146	+94		
														+150	+114	+171	+114		
														+166	+126	+189	+126		
														+172	+132	+195	+132		
Normal Dimensions mm		Clearance																	
max (c)	max (i)	min	max	min	max	min	max	min	max	min	max	min	max	min	max	min	max	min	max
4	12	1	14	1	17	4	17	4	20	8	24	12	28	-	-	-	-	-	-
4.5	12.5	1	15	1	18	6	20	6	23	10	27	15	32	-	-	-	-	-	-
5.5	13.5	1	17	1	20	7	23	7	26	12	31	18	37	-	-	-	-	-	-
6.5	16.5	2	21	2	25	8	27	8	31	15	38	22	45	-	-	-	-	-	-
8	20	2	25	2	30	9	32	9	37	17	45	26	54	-	-	-	-	-	-
9.5	24.5	2	30	2	36	11	39	11	45	20	54	32	68	-	-	-	-	-	-
11	31	3	38	3	45	13	48	13	55	23	65	37	79	-	-	-	-	-	-
12.5	37.5	3	46	3	53	15	58	15	65	27	77	43	93	63	113	-	-	-	-
														65	115	-	-	-	-
														68	118	-	-	-	-
														77	136	77	153	-	-
14.5	44.5	4	54	4	63	17	67	17	76	31	90	50	109	80	139	80	156	-	-
														84	143	84	160	-	-
16	51	4	62	4	71	20	78	20	87	34	101	56	123	94	161	94	181	-	-
														98	165	98	185	-	-
18	58	4	69	4	80	21	86	21	97	37	113	62	138	108	184	108	205	-	-
														114	190	114	211	-	-
20	65	5	77	5	90	23	95	23	108	40	125	68	153	126	211	126	234	-	-
														132	217	132	240	-	-

Table 9.8 The Fits between Radial Bearing and Housing (except taper roller bearing), Class P0

Normal Dimensions mm		Inner Diameters ΔD_{mp}		Tolerance Zones for Shafts														
				G7	H8	H7	H6	J7	J6	Js7	Limiting Deviation of Journal Diameter							
over	include	high	low															
10	18	0	-8	+24	+6	+27	0	+18	0	+11	0	+10	-8	+6	-5	+9	-9	
18	30	0	-9	+28	+7	+33	0	+21	0	+13	0	+12	-9	+8	-5	+10	-10	
30	50	0	-11	+34	+9	+39	0	+25	0	+16	0	+14	-11	+10	-6	+12	-12	
50	80	0	-13	+40	+10	+46	0	+30	0	+19	0	+18	-12	+13	-6	+15	-15	
80	120	0	-15	+47	+12	+54	0	+35	0	+22	0	+22	-13	+16	-6	+17	-17	
120	150	0	-18	+54	+14	+63	0	+40	0	+25	0	+26	-14	+18	-7	+20	-20	
150	180	0	-25	+54	+14	+63	0	+40	0	+25	0	+26	-14	+18	-7	+20	-20	
180	250	0	-30	+61	+15	+72	0	+46	0	+29	0	+30	-16	+22	-7	+23	-23	
250	315	0	-35	+69	+17	+81	0	+52	0	+32	0	+36	-16	+25	-7	+26	-26	
315	400	0	-40	+75	+18	+89	0	+57	0	+36	0	+39	-18	+29	-7	+28	-28	
400	500	0	-45	+83	+20	+97	0	+63	0	+40	0	+43	-20	+33	-7	+31	-31	

Normal Dimensions mm		Clearance		Clearance or Interference													
over	include	min	max	max (c)	max (i)	max (c)	max (i)	max (c)	max (i)	max (c)	max (i)	max (c)	max (i)	max (c)	max (i)		
10	18	32	6	35	0	26	0	19	0	18	8	14	5	17	9		
18	30	37	7	42	0	30	0	22	0	21	9	17	5	19	10		
30	50	45	9	50	0	36	0	27	0	25	11	21	6	23	12		
50	80	53	10	59	0	43	0	32	0	31	12	26	6	28	15		
80	120	62	12	69	0	50	0	37	0	37	13	31	6	32	17		
120	150	72	14	81	0	58	0	43	0	44	14	36	7	38	20		
150	180	79	14	88	0	65	0	50	0	51	14	43	7	45	20		
180	250	91	15	102	0	76	0	59	0	60	16	52	7	53	23		
250	315	104	17	116	0	87	0	67	0	71	16	60	7	61	26		
315	400	115	18	129	0	97	0	76	0	79	18	69	7	68	28		
400	500	128	20	142	0	108	0	85	0	88	20	78	7	76	31		

Note: "--" stands for interference

Tolerance Zones for Shafts																		
JS6	K6	K7	M6	M7	N6	N7	P6	P7	Limiting Deviation of Journal Diameter									
+5.5	-5.5	+2	-9	+6	-12	-4	-15	0	-18	-9	-20	-5	-23	-15	-26	-11	-29	
+6.5	-6.5	+2	-11	+6	-15	-4	-17	0	-21	-11	-24	-7	-28	-18	-31	-14	-35	
+8	-8	+3	-13	+7	-18	-4	-20	0	-25	-12	-28	-8	-33	-21	-37	-17	-42	
+9.5	-9.5	+4	-15	+9	-21	-5	-24	0	-30	-14	-33	-9	-39	-26	-45	-21	-51	
+11	-11	+4	-18	+10	-25	-6	-28	0	-35	-16	-38	-10	-45	-30	-52	-24	-59	
+12.5	-12.5	+4	-21	+12	-28	-8	-33	0	-40	-20	-45	-12	-52	-36	-61	-28	-68	
+12.5	-12.5	+4	-21	+12	-28	-8	-33	0	-40	-20	-45	-12	-52	-36	-61	-28	-68	
+14.5	-14.5	+5	-24	+13	-33	-8	-37	0	-46	-22	-51	-14	-60	-41	-70	-33	-79	
+16	-16	+5	-27	+16	-36	-9	-41	0	-52	-25	-57	-14	-66	-47	-79	-36	-88	
+18	-18	+7	-29	+17	-40	-10	-46	0	-57	-26	-62	-16	-73	-51	-87	-41	-98	
+20	-20	+8	-32	+18	-45	-10	-50	0	-63	-27	-67	-17	-80	-55	-95	-45	-108	

Clearance or Interference														Interference			
max (c)	max (i)	max (c)	max (i)	max (c)	max (i)	max (c)	max (i)	max (c)	max (i)	max (c)	max (i)	min	max	min	max		
13.5	5.5	10	9	14	12	4	15	8	18	-1	20	3	23	7	26	3	29
15.5	6.5	11	11	15	15	5	17	9	21	2	24	2	28	9	31	5	35
19	8	14	13	18	18	7	20	11	25	-1	28	3	33	10	37	6	42
22.5	9.5	17	15	22	21	8	24	13	30	-1	33	4	39	13	45	8	51
26	11	19	18	25	25	9	28	15	35	-1	38	5	45	15	52	9	59
30.5	12.5	22	21	30	28	10	33	18	40	-2	45	6	52	18	61	10	68
37.5	12.5	29	21	37	28	17	33	25	40	5	45	13	52	11	61	3	68
44.5	14.5	35	24	43	33	22	37	30	46	8	51	16	60	11	70	3	79
51	16	40	27	51	36	26	41	35	52	10	57	21	66	12	79	1	88
58	18	47	29	57	40	30	46	40	57	14	62	24	73	11	87	1	98
65	20	53	32	63	45	35	50	45	63	18	67	28	80	10	95	0	108

Table 9.9 The Fits between Radial Bearing and Shaft (except taper roller bearing), Class P6

Normal Dimensions mm		Inner Diameters Δ_{dmp}		Tolerance Zones for Shafts											
				g6	g5	h6	h5	j5	j6	Limiting Deviation of Journal Diameter					
over	include	high	low												
3	6	0	-7	-4	-12	-4	-9	0	-8	0	-5	+3	-2	+6	-2
6	10	0	-7	-5	-14	-5	-11	0	-9	0	-6	+4	-2	+7	-2
10	180	0	-7	-6	-17	-6	-14	0	-11	0	-8	+5	-3	+8	-3
18	30	0	-8	-7	-20	-7	-16	0	-13	0	-9	+5	-4	+9	-4
30	50	0	-10	-9	-25	-9	-20	0	-16	0	-11	+6	-5	+11	-5
50	80	0	-12	-10	-29	-10	-23	0	-19	0	-13	+6	-7	+12	-7
80	120	0	-15	-12	-34	-12	-27	0	-22	0	-15	+6	-9	+13	-9
120	140														
140	160	0	-18	-14	-39	-14	-32	0	-25	0	-18	+7	-11	+14	-11
160	180														
180	200														
200	225	0	-22	-15	-44	-15	-35	0	-29	0	-20	+7	-13	+16	-13
225	250														
250	280	0	-25	-17	-49	-17	-40	0	-32	0	-23	+7	-16	-	-
280	315														
315	355	0	-30	-18	-54	-18	-43	0	-36	0	-25	+7	-18	-	-
355	400														
400	450	0	-35	-20	-60	-20	-47	0	-40	0	-27	+7	-20	-	-
450	500														
Normal Dimensions mm		Clearance or Interference													
over	include	max (c)	max (i)	max (c)	max (i)	max (c)	max (i)	max (c)	max (i)	max (c)	max (i)	max (c)	max (i)	max (c)	max (i)
3	6	12	3	9	3	8	7	5	7	2	10	2	13		
6	10	14	2	11	2	9	7	6	7	2	11	2	14		
10	18	17	1	14	1	11	7	8	7	3	12	3	15		
18	30	20	1	16	1	13	8	9	8	4	13	4	17		
30	50	25	1	20	1	16	10	11	10	5	16	5	21		
50	80	29	2	23	2	19	12	13	12	7	18	7	24		
80	120	34	3	27	3	22	15	15	15	9	21	9	28		
120	140														
140	160	39	4	32	4	25	18	18	18	11	25	11	32		
160	180														
180	200														
200	225	44	7	35	7	29	22	20	22	13	29	13	38		
225	250														
250	280	49	8	40	8	32	25	23	25	16	32	-	-		
280	315														
315	355	54	12	43	12	36	30	25	30	18	37	-	-		
355	400														
400	450	60	15	47	15	40	35	27	35	20	42	-	-		
450	500														

Normal Dimensions mm		Tolerance Zones for Shafts																	
		js6	k5	k6	m5	m6	n6	p6	r6	r7	Limiting Deviation of Journal Diameter								
over	include	high	low																
+4	-4	+6	+1	+9	+1	+9	+4	+12	+4	+16	+8	+20	+12	-	-	-	-		
+4.5	-4.5	+7	+1	+10	+1	+12	+6	+15	+6	+19	+10	+24	+15	-	-	-	-		
+5.5	-5.5	+9	+1	+12	+1	+15	+7	+18	+7	+23	+12	+29	+18	-	-	-	-		
+6.5	-6.5	+11	+2	+15	+2	+17	+8	+21	+8	+28	+15	+35	+22	-	-	-	-		
+8	-8	+13	+2	+18	+2	+20	+9	+25	+9	+33	+17	+42	+26	-	-	-	-		
+9.5	-9.5	+15	+2	+21	+2	+24	+11	+30	+11	+39	+20	+51	+32	-	-	-	-		
+11	-11	+18	+3	+25	+3	+28	+13	+35	+13	+45	+23	+59	+37	-	-	-	-		
+12.5	-12.5	+21	+3	+28	+3	+33	+15	+40	+15	+52	+27	+68	+43	+88	+63	-	-		
+14.5	-14.5	+24	+4	+33	+4	+37	+17	+46	+17	+60	+31	+79	+50	+90	+65	+106	+77		
+16	-16	+27	+4	+36	+4	+43	+20	+52	+20	+66	+34	+88	+56	+93	+68	+109	+80		
+18	-18	+29	+4	+40	+4	+46	+21	+57	+21	+73	+37	+98	+62	+106	+77	+113	+84		
+20	-20	+32	+5	+45	+5	+50	+23	+63	+23	+80	+40	+108	+68	+109	+80	+113	+84		
														+126	+94	+146	+94		
														+130	+98	+150	+98		
														+144	+108	+165	+108		
														+150	+114	+171	+114		
														+166	+126	+189	+126		
														+172	+132	+195	+132		
Normal Dimensions mm		Clearance																	
max (c)	max (i)	min	max	min	max	min	max	min	max	min	max	min	max	min	max	min	max	min	max
4	11	1	13	1	16	4	16	4	19	8	23	12	27	-	-	-	-	-	-
4.5	11.5	1	14	1	17	6	19	6	22	10	26	15	31	-	-	-	-	-	-
5.5	12.5	1	16	1	19	7	22	7	25	12	30	18	36	-	-	-	-	-	-
6.5	14.5	2	19	2	23	8	25	8	29	15	36	22	43	-	-	-	-	-	-
8	18	2	23	2	28	9	30	9	35	17	43	26	52	-	-	-	-	-	-
9.5	21.5	2	27	2	33	11	36	11	42	20	51	32	63	-	-	-	-	-	-
11	26	3	33	3	40	13	43	13	50	23	61	37	74	-	-	-	-	-	-
12.5	30.5	3	39	3	46	15	51	15	58	27	70	+43	86	63	106	65	108	-	-
														68	111	77	128	77	145
														80	131	80	148	80	148
														84	135	84	152	84	152
														94	151	94	171	94	171
														98	155	98	175	98	175
														108	174	108	195	108	195
														114	180	114	201	114	201
														126	201	126	224	126	224
														132	207	132	230	132	230

Table 9.10 The Fits between Radial Bearing and Housing (except taper roller bearing), Class P6

Normal Dimensions mm		Inner Diameters ΔD_{mp}		Tolerance Zones for Shafts														
				G7	H8	H7	H6	J7	J6	Js7	Limiting Deviation of Journal Diameter							
over	include	high	low															
10	18	0	-7	+24	+6	+27	0	+18	0	+11	0	+10	-8	+6	-5	+9	-9	
18	30	0	-8	+28	+7	+33	0	+21	0	+13	0	+12	-9	+8	-5	+10	-10	
30	50	0	-9	+34	+9	+39	0	+25	0	+16	0	+14	-11	+10	-6	+12	-12	
50	80	0	-11	+40	+10	+46	0	+30	0	+19	0	+18	-12	+13	-6	+15	-15	
80	120	0	-13	+47	+12	+54	0	+35	0	+22	0	+22	-13	+16	-6	+17	-17	
120	150	0	-15	+54	+14	+63	0	+40	0	+25	0	+26	-14	+18	-7	+20	-20	
150	180	0	-18	+54	+14	+63	0	+40	0	+25	0	+26	-14	+18	-7	+20	-20	
180	250	0	-20	+61	+15	+72	0	+46	0	+29	0	+30	-16	+22	-7	+23	-23	
250	315	0	-25	+69	+17	+81	0	+52	0	+32	0	+36	-16	+25	-7	+26	-26	
315	400	0	-28	+75	+18	+89	0	+57	0	+36	0	+39	-18	+29	-7	+28	-28	
400	500	0	-33	+83	+20	+97	0	+63	0	+40	0	+43	-20	+33	-7	+31	-31	

Normal Dimensions mm		Clearance		Clearance or Interference													
over	include	min	max	max (c)	max (i)	max (c)	max (i)	max (c)	max (i)	max (c)	max (i)	max (c)	max (i)	max (c)	max (i)		
10	18	31	6	34	0	25	0	18	0	17	8	13	5	16	9		
18	30	36	7	41	0	29	0	21	0	20	9	16	5	18	10		
30	50	43	9	48	0	34	0	25	0	23	11	19	6	21	12		
50	80	51	10	57	0	41	0	30	0	29	12	24	6	26	15		
80	120	60	12	67	0	48	0	35	0	35	13	29	6	30	17		
120	150	69	14	78	0	55	0	40	0	41	14	33	7	35	20		
150	180	72	14	81	0	58	0	43	0	44	14	36	7	38	20		
180	250	81	15	92	0	66	0	49	0	50	16	42	7	43	23		
250	315	94	17	106	0	77	0	57	0	61	16	50	7	51	26		
315	400	103	18	117	0	85	0	64	0	67	18	57	7	56	28		
400	500	116	20	130	0	96	0	73	0	76	20	66	7	64	31		

Tolerance Zones for Shafts																	
JS6	K6	K7	M6	M7	N6	N7	P6	P7	Limiting Deviation of Journal Diameter								
+5.5	-5.5	+2	-9	+6	-12	-4	-15	0	-18	-9	-20	-5	-23	-15	-26	-11	-29
+6.5	-6.5	+2	-11	+6	-15	-4	-17	0	-21	-11	-24	-7	-28	-18	-31	-14	-35
+8	-8	+3	-13	+7	-18	-4	-20	0	-25	-12	-28	-8	-33	-21	-37	-17	-42
+9.5	-9.5	+4	-15	+9	-21	-5	-24	0	-30	-14	-33	-9	-39	-26	-45	-21	-51
+11	-11	+4	-18	+10	-25	-6	-28	0	-35	-16	-38	-10	-45	-30	-52	-24	-59
+12.5	-12.5	+4	-21	+12	-28	-8	-33	0	-40	-20	-45	-12	-52	-36	-61	-28	-68
+12.5	-12.5	+4	-21	+12	-28	-8	-33	0	-40	-20	-45	-12	-52	-36	-61	-28	-68
+14.5	-14.5	+5	-24	+13	-33	-8	-37	0	-46	-22	-51	-14	-60	-41	-70	-33	-79
+16	-16	+5	-27	+16	-36	-9	-41	0	-52	-25	-57	-14	-66	-47	-79	-36	-88
+18	-18	+7	-29	+17	-40	-10	-46	0	-57	-26	-62	-16	-73	-51	-87	-41	-98
+20	-20	+8	-32	+18	-45	-10	-50	0	-63	-27	-67	-17	-82	-55	-95	-45	-108

Clearance or Interference														Interference			
max (c)	max (i)	max (c)	max (i)	max (c)	max (i)	max (c)	max (i)	max (c)	max (i)	max (c)	max (i)	max (c)	max (i)	min	max	min	max
12.5	5.5	9	9	13	12	3	15	7	18	-2	20	2	23	8	26	4	29
14.5	6.5	10	11	14	15	4	17	8	21	-3	24	1	28	10	31	6	35
17	8	12	13	16	18	5	20	9	25	-3	28	1	33	12	37	8	42
20.5	9.5	15	15	20	21	6	24	11	30	-3	33	2	39	15	45	10	51
24	11	17	18	23	25	7	28	13	35	-3	38	3	45	17	52	11	59
27.5	12.5	19	21	27	28	7	33	15	40	-5	45	3	52	21	61	13	68
30.5	12.5	22	21	30	28	10	33	18	40	-2	45	6	52	18	61	10	68
34.5	14.5	25	24	33	33	12	37	20	46	-2	51	6	60	21	70	13	79
41	16	30	27	41	36	16	41	25	52	0	57	11	66	22	79	11	88
46	18	35	29	45	40	18	46	28	57	2	62	12	73	23	87	13	98
53	20	41	32	51	45	23	50	33	63	6	67	16	80	22	95	12	108

Table 9.11 The Fits between Taper Roller Bearing and Shaft, Class P0, P6x

Normal Dimensions mm		Inner Diameters Δ_{dmp}		Tolerance Zones for Shafts											
				f6		g6		g5		h6		h5		j5	
over	include	high	low	Limiting Deviation of Journal Diameter											
10	18	0	-12	-16	-27	-6	-17	-6	-14	0	-11	0	-8	+5	-3
18	30	0	-12	-20	-33	-7	-20	-7	-16	0	-13	0	-9	+5	-4
30	50	0	-12	-25	-41	-9	-25	-9	-20	0	-16	0	-11	+6	-5
50	80	0	-15	-30	-49	-10	-29	-10	-23	0	-19	0	-13	+6	-7
80	120	0	-20	-36	-58	-12	-34	-12	-27	0	-22	0	-15	+6	-9
120	140														
140	160	0	-25	-43	-68	-14	-39	-14	-32	0	-25	0	-18	+7	-11
160	180														
180	200														
200	225	0	-30	-50	-79	-15	-44	-15	-35	0	-29	0	-20	+7	-13
225	250														
250	280	0	-35	-56	-88	-17	-49	-17	-40	0	-32	0	-23	+7	-16
280	315														
315	355	0	-40	-62	-98	-18	-54	-18	-43	0	-36	0	-25	+7	-18
355	400														
400	450	0	-45	-68	-108	-20	-60	-20	-47	0	-40	0	-27	+7	-20
450	500														
Normal Dimensions mm		Clearance or Interference													
over	include	max (c)	max (i)	max (c)	max (i)	max (c)	max (i)	max (c)	max (i)	max (c)	max (i)	max (c)	max (i)	max (c)	max (i)
10	18	27	4	17	6	14	6	11	12	8	12	3	18		
18	30	33	8	20	5	16	5	13	12	9	12	4	18		
30	50	41	13	25	3	20	3	16	12	11	12	5	18		
50	80	49	15	29	5	23	5	19	15	13	15	7	21		
80	120	58	16	34	8	27	8	22	20	15	20	9	26		
120	140														
140	160	68	18	39	11	32	11	25	25	18	25	11	32		
160	180														
180	200														
200	225	79	20	44	15	35	15	29	30	20	30	13	37		
225	250														
250	280	88	21	49	18	40	18	32	35	23	35	16	42		
280	315														
315	355	98	22	54	22	43	22	36	40	25	40	18	47		
355	400														
400	450	108	23	60	25	47	25	40	45	27	45	20	52		
450	500														

Normal Dimensions mm		Tolerance Zones for Shafts																	
		j6		js5		k5		k6		m5		m6		n6		p6		r6	
over	include	high	low	Limiting Deviation of Journal Diameter															
+8	-3	+5.5	-5.5	+9	+1	+12	+1	+15	+7	+18	+7	+23	+12	+29	+18	-	-		
+9	-4	+6.5	-6.5	+11	+2	+15	+2	+17	+8	+21	+8	+28	+15	+35	+22	-	-		
+11	-5	+8	-8	+13	+2	+18	+2	+20	+9	+25	+9	+33	+17	+42	+26	-	-		
+12	-7	+9.5	-9.5	+15	+2	+21	+2	+24	+11	+30	+11	+39	+20	+51	+32	-	-		
+13	-9	+11	-11	+18	+3	+25	+3	+28	+13	+35	+13	+45	+23	+59	+37	-	-		
+14	-11	+12.5	-12.5	+21	+3	+28	+3	+33	+15	+40	+15	+52	+27	+68	+43	+68	+63		
																+90	+65		
																+93	+68		
																+106	+77		
+16	-13	+14.5	-14.5	+24	+4	+33	+4	+37	+17	+46	+17	+60	+31	+79	+50	+109	+80		
																+113	+84		
-	-	+16	-16	+27	+4	+36	+4	+43	+20	+52	+20	+66	+34	+88	+56	+126	+94		
																+130	+98		
-	-	+18	-18	+29	+4	+40	+4	+46	+21	+57	+21	+73	+37	+98	+62	+144	+108		
																+150	+114		
-	-	+20	-20	+3	+5	+45	+5	+50	+23	+63	+23	+80	+40	+108	+68	+166	+126		
																+172	+132		
Normal Dimensions mm		Clearance																	
max (c)	max (i)	min	max	min	max	min	max	min	max	min	max	min	max	min	max	min	max		
3	20	5.5	17.5	-	-	-	-	-	-	-	-	-	-	-	-	-	-		
4	21	6.5	18.5	2	23	2	27	-	-	-	-	-	-	-	-	-	-		
5	23	8	20	2	25	2	30	9	32	9	37	-	-	-	-	-	-		
7	27	9.5	24.5	2	30	2	36	11	39	11	45	20	54	-	-	-	-		
9	33	11	31	3	38	3	45	13	48	13	55	23	65	37	79	-	-		
11	39	12.5	37.5	3	46	3	53	15	58	15	65	27	77	43	93	63	113		
																65	115		
																68	118		
																77	136		
13	46	14.5	44.5	4	54	4	63	17	67	17	77	31	90	50	109	80	139		
																84	143		
-	-	16	51	4	62	4	71	20	78	20	87	34	101	56	123	94	161		
																98	165		
-	-	18	58	4	69	4	80	21	86	21	97	37	113	62	138	108	184		
																114	190		
-	-	20	65	5	77	5	90	23	95	23	108	40	125	68	153	126	211		
																132	217		

Table 9.12 The Fits Between Taper Roller Bearing and Housing, Class P0, P6x

Normal Dimensions mm		Inner Diameters Δ_{dmp}		Tolerance Zones for Shafts													
				G7		H8		H7		H6		J7		J6		Js7	
over	include	high	low	Limiting Deviation of Journal Diameter													
30	50	0	-14	+34	+9	+39	0	+25	0	+16	0	+14	-11	+10	-6	+12	-12
50	80	0	-16	+40	+10	+46	0	+30	0	+19	0	+18	-12	+13	-6	+15	-15
80	120	0	-18	+47	+12	+54	0	+35	0	+22	0	+22	-13	+16	-6	+17	-17
120	150	0	-20	+54	+14	+63	0	+40	0	+25	0	+26	-14	+18	-7	+20	-20
150	180	0	-25	+54	+14	+63	0	+40	0	+25	0	+26	-14	+18	-7	+20	-20
180	250	0	-30	+61	+15	+72	0	+46	0	+29	0	+30	-16	+22	-7	+23	-23
250	315	0	-35	+69	+17	+81	0	+52	0	+32	0	+36	-16	+25	-7	+26	-26
315	400	0	-40	+75	+18	+89	0	+57	0	+36	0	+39	-18	+29	-7	+28	-28
400	500	0	-45	+83	+20	+97	0	+63	0	+40	0	+43	-20	+33	-7	+31	-31

Normal Dimensions mm		Clearance		Clearance or Interference													
over	include	min	max	max (c)	max (i)	max (c)	max (i)	max (c)	max (i)	max (c)	max (i)	max (c)	max (i)	max (c)	max (i)	max (c)	max (i)
30	50	48	9	50	0	39	0	30	0	28	11	24	6	26	12		
50	80	56	10	59	0	46	0	35	0	34	12	29	6	31	15		
80	120	65	12	69	0	53	0	40	0	40	13	34	6	35	17		
120	150	74	14	81	0	60	0	45	0	46	14	38	7	40	20		
150	180	79	14	88	0	65	0	50	0	51	14	43	7	45	20		
180	250	91	15	102	0	76	0	59	0	60	16	52	7	53	23		
250	315	104	17	116	0	87	0	67	0	71	16	60	7	61	26		
315	400	115	18	129	0	97	0	76	0	79	18	69	7	68	28		
400	500	128	20	142	0	108	0	85	0	88	20	78	7	76	31		

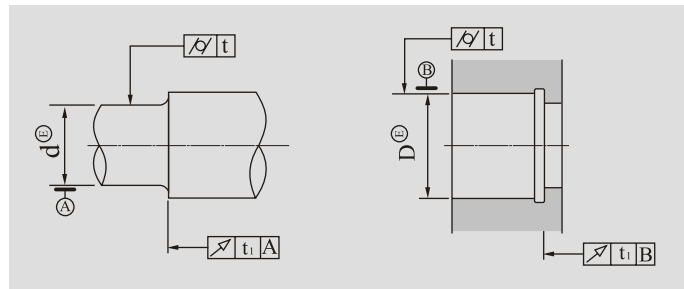

Fig 9.1

The form tolerances of shaft and housing bores are shown in Table 9.13, and the roughness of fitting surface are shown in Table 9.14.

Tolerance Zones for Shafts																	
Js6		K6		K7		M6		M7		N6		N7		P6		P7	
Limiting Deviation of Journal Diameter																	
+8.5	-8.5	+3	-13	+7	-18	-4	-20	0	-25	-12	-28	-8	-33	-21	-37	-17	-42
+9.5	-9.5	+4	-15	+9	-21	-57	-24	0	-30	-14	-33	-9	-39	-26	-45	-21	-51
+11	-11	+4	-18	+10	-25	-6	-28	0	-35	-16	-38	-10	-45	-30	-52	-24	-59
+12.5	-12.5	+4	-21	+12	-28	-8	-33	0	-40	-20	-45	-12	-52	-36	-61	-28	-68
+12.5	-12.5	+4	-21	+12	-28	-8	-33	0	-40	-20	-45	-12	-52	-36	-61	-28	-68
+14.5	-14.5	+5	-24	+13	-33	-8	-37	0	-46	-22	-51	-14	-60	-41	-70	-33	-79
+16	-16	+5	-27	+16	-36	-9	-41	0	-52	-25	-57	-14	-66	-47	-79	-36	-88
+18	-18	+7	-29	+17	-40	-10	-46	0	-57	-26	-62	-16	-73	-51	-87	-41	-98
+20	-20	+8	-32	+18	-45	-10	-50	0	-63	-27	-67	-17	-80	-55	-95	-45	-108

Clearance or Interference														Interference			
max (c)	max (i)	max (c)	max (i)	max (c)	max (i)	max (c)	max (i)	max (c)	max (i)	max (c)	max (i)	max (c)	max (i)	min	max	min	max
22	8	17	13	21	18	10	20	14	25	2	28	6	33	7	37	3	42
25.5	9.5	20	15	25	21	11	24	16	30	2	33	7	39	10	45	5	51
29	11	22	18	28	25	12	28	18	35	2	38	8	45	12	52	6	59
32.5	12.5	24	21	32	28	12	33	20	40	0	45	8	52	16	61	8	68
37.5	12.5	29	21	37	28	17	33	25	40	5	45	13	52	11	61	3	68
44.5	14.5	35	24	43	33	22	37	30	46	8	51	16	60	11	70	3	79
51	16	40	27	51	36	26	41	35	52	10	57	21	66	12	79	1	88
58	18	47	29	57	40	30	46	40	57	14	62	24	73	11	87	1	98
65	20	53	32	63	45	35	50	45	63	18	67	28	80	10	95	0	108

Table 9.13

Normal Dimensions mm		Cylindricity t				Face Runout t_1			
		Journal		Housing Bore		Shoulder		Shoulder of Housing Bore	
		Tolerance Class							
		P0	P6 (P6x)	P0	P6 (P6x)	P0	P6 (P6x)	P0	P6 (P6x)
Over	Include	Tolerance Value, μm							
6	6	2.5	1.5	4	2.5	5	3	8	5
10	10	2.5	1.5	4	2.5	6	4	10	6
18	18	3	2	5	3	8	5	12	8
18	30	4	2.5	6	4	10	6	15	10
30	50	4	2.5	7	4	12	8	20	12
50	80	5	3	8	5	15	10	25	15
80	120	6	4	10	6	15	10	25	15
120	180	8	5	12	8	20	12	30	20
180	250	10	7	14	10	20	12	30	20
250	315	12	8	16	12	25	15	40	25
315	400	13	9	18	13	25	15	40	25
400	500	15	10	20	15	25	15	40	25

Table 9.14

Diameter of Shaft or Housing mm		Tolerance Class of Fitting Surface Diameter of Shaft of Housing											
		IT7				IT6				IT5			
		Surface Roughness											
Over	Incl	Ra		Rz	Ra		Rz	Ra					
		Grinding	Turning		Grinding	Turning		Grinding	Turning				
80	80	10	1.6	3.2	6.3	0.8	1.6	4	0.4	0.8			
80	500	16	1.6	3.2	10	1.6	3.2	6.3	0.8	1.6			
End face		25	3.2	6.3	25	3.2	3.2	10	1.6	3.2			

9.2 Bearing Configuration

The bearings supporting structure plays an important role in assuring the bearing's running accuracy, therefore, while designing the supporting structure, the bearings configuration should be considered.

As mentioned previously, rotating shafts in normal machines usually adopt double supporting structure, each one is made up by one or two sets of supporting structure. The fixed shafts in the supporting structure are limited in the radial direction by two supporting structures, which, is carried out through matching. In the axial direction there will be three methods to limit. This, which, are supporting with both ends fixed, supporting with a fixed end and a wandering end, and supporting with both ends wandering.

9.2.1 Supporting with Both Ends Fixed

Supporting with both ends fixed means the supporting structure with each one of the two supporting respectively must limit any axial movement. This is shown in Fig 9.2. These types of structures allow for maintenance adjustment when necessary. When angular contact bearings (E.g. angular contact ball bearing, taper roller bearings) are selected and are preloaded this allows for improved running accuracy of the bearing, this also improves the potential so as to avoid roller slippage. These types of mounts are normally used where high accuracy, light load and high speed are required.

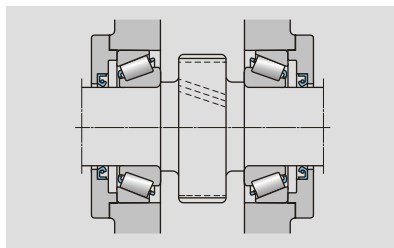

Fig 9.2

9.2.2 Supporting with a Fixed End and a Wandering One

Supporting with a fixed end and a wandering one means one of the supporting ends on the shaft allows the bearing fixed relative to the shaft and the housing (called the fixed end), which, is in order to limit the shaft's axial distance. Moreover, on the other ends, the bearing can wander relative to the shaft or the housing (called the walking end), which, is in order to make up the length

change of the shaft because of heating deformation, manufacture or installation error. The supporting structure is shown in Fig 9.3, in which the left end is fixed end and the right end is the wandering end. In this kind of supporting structure, the axial position accuracy of the shaft lies on the axial clearance of the bearing on the fixed end.

Supporting with a fixed end and a wandering one has a high running accuracy and a high flexibility for all types of working situations, this is especially suitable for the low requirement of axial position space between the two supporting on the shaft and the housing. This type of structure is widely used in various machine tools' principal axis, worm shafts in high working temperature and long shafts of large span.

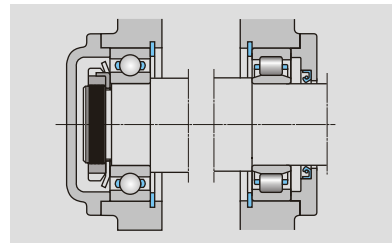

Fig 9.3

9.2.3 Supporting with Both Ends Wandering

Supporting with both ends wandering means the two supporting ends have no limit for axial distance of the shaft. Therefore, this kind of supporting is usually used in the conditions of the axial position of shaft having been limited by other components, such as herringbone wheel shaft supporting. Supporting structure is shown in Fig 9.4.

The supporting with both ends does not need to limit the shaft's axial position accurately, therefore, there is no need to adjust the bearing's axial clearance while assembling. The bearing will not lock even working in a high-temperature situation.

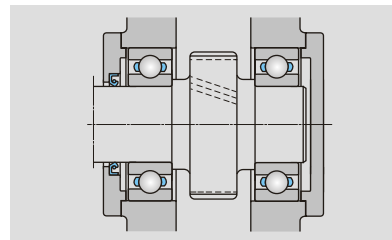

Fig 9.4

9.3 Axial Fixation

Only interference fit is not enough for bearing's axial fixation, especially when under axial loads. Therefore, to prevent the bearings from unnecessary axial movement on the shaft or the housing, the inner and outer ring must be axial fixed. Axial fixation includes axial location and axial fastening.

9.3.1 Axial Location

When the bearing is mounted, one side of the inner or outer end face abuts a shoulder on the shaft or in the housing bore at one side. Usually, the base end face of inner ring is located by the shaft shoulder; the base end face of outer ring is located by the shoulder of housing bore. In order to make sure the bearing end face clung to the shaft shoulder, we must make sure the chamfer r_{smax} of the shaft shoulder (supporter) is less than the chamfer of fixation r_{smin} , which is shown in Fig 9.5. The choice of the max radius of rounded angle of shaft shoulder (supporter) is shown in Fig 9.15. The min height of shaft shoulder (supporter) is shown in Fig 9.16.

The shaft shoulder should be designed with a

certain height to transfer axial load. The more the axial load, the higher the height is. However, concerning the problem of disassembling, the height of shaft shoulder is usually no more than the size of flange (or raceway). If they are very close, then a disassembling slot should be designed on the shaft shoulder.

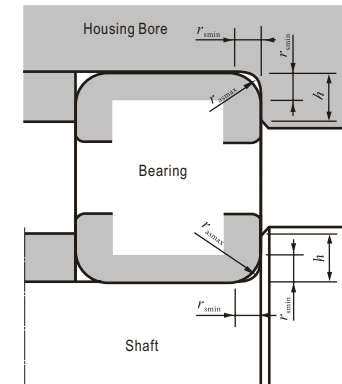

Fig 9.5

Table 9.15

Max Fillet Radius of Shoulder

		mm	
r_{smin}	r_{smax}	r_{smin}	r_{smax}
0.05	0.05	2	2
0.08	0.08	2.1	2
0.1	0.1	3	2.5
0.15	0.15	4	3
0.2	0.2	5	4
0.3	0.3	6	5
0.6	0.6	7.5	6
1	1	9.5	8
1.1	1.1	12	10
1.5	1.5	15	12

Table 9.16

Min Height of Shoulder

				mm	
r_{smin}	h_{min}		r_{smin}	h_{min}	
	Normal Condition	Special Condition ^a		Normal Condition	Special Condition ^a
0.05	0.2	-	2	5	4.5
0.08	0.3	-	2.1	6	5.5
0.1	0.4	-	3	7	6.5
0.15	0.6	-	4	9	8
0.2	0.8	-	5	11	10
0.3	1.2	1	6	14	12
0.6	2.5	2	7.5	18	-
1	3	2.5	9.5	22	-
1.1	3.5	3.3	12	27	-
1.5	4.5	4	15	32	-

Note: Special conditions mean thrust load is infinite small, or shoulder is designed to be less than.

The types of axial location of bearings, inner ring fixation is shown in Table 9.17 and outer ring fixation is shown in Table 9.18.

Table 9.17

Types of Fixation	Sketches	Examples of Application
Lock nut		Inner ring is axially fixed by shoulder and lock nut, and the lock washer is used to prevent from loosening. It is suitable for high speed and heavy load.
Shoulder		Inner ring achieves axial fixation by shoulder and interference fit, and outside of the outer ring is fastened by end cover. Its characteristic is simple in structure and small size outline which is suitable for supporting arrangement at both sides.
Elastic washer		Axial fixation is achieved by shoulder and elastic washer. Light axial load of double direction can be carried. It is space saving and also easy to mount and dismount.
Adaptor sleeve		Inner ring is radically pressed by adaptor and lock nut and fixed on the shaft to achieve axial fixation. It is suitable for lower speed, steady radial load and small axial load.
Withdrawal sleeve		Similar to the adaptor sleeve, the withdraw sleeve itself has a shaft nut. It is easy to mount and dismount. It is suitable for heavier radial load and light axial load.

Table 9.18

Types of Fixation	Sketches	Examples of Application
Snap ring		It is often used in deep groove ball bearings with snap ring groove on the outer ring. It is simple in structure and has small axial dimension, but larger axial load cannot be endured.
Elastic washer		It is simple in structure, easy to mount or dismount, and the axial dimension is small. Put the adjusting ring between axial end surface and bead flange which can also adjust the bearing's axial location, and compensate for the errors in processing and assembling. It is suitable for the condition with high speed and lighter axial load.
End cover		It is used to fix where radial bearing and angular contact bearing at the axle head. End covers can be made in many types. When end cover is through hole, it can also have various kinds of seal glands. It is suitable for the condition with high speed and heavier axial load.
Screw thread		It is suitable for the condition with high speed and heavier axial load. It can also adjust inner clearance of the radial thrust bearing. Screw ring should have methods to prevent loosen.
Adjusting bolt and cover fixation		It is similar to the end cover and easy to adjust the bearing clearance at the outside of the boxes. Screw adjustment should have the corresponding measures to prevent loosen.

9.3.2 Axial Tightening

The bearing's axial tightening is to ensure that the bearing be always on the position confirmed by axial fixation. Axial tightening includes inner ring fixed on the shaft and outer ring fixed in the shaft block. Although the inner and outer rings are required to be fixed accurately, the simultaneous axial fixation is not a necessary. This should depend on the supporting requirement:

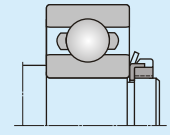
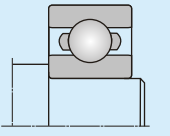
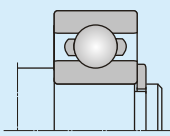
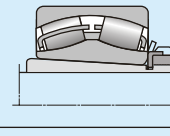
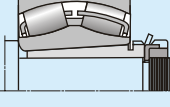
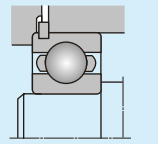
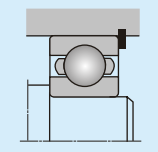
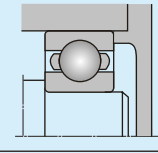
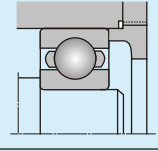
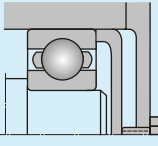
- The structure of supporting with both ends fixed needs to be fixed only in one direction against the load, because it carries the axial load only in one direction.
- The structure of supporting with a fixed end and a wandering one needs to be fixed in both directions because the fixed end will carry the bidirectional loads. The wandering end should depend on the bearing types. If a non-

separable bearing is selected then only one of the rings needs to be fixed and the walking ring is not fixed. If the separable bearing is selected, then two rings should be fixed in both directions typically in the cylindrical roller bearing.

9.3.3 Axial Fixation Device

There are many types of device for axial fixation. When selecting them, many factors such as magnitude of axial load, rotating speed, bearing's type, installation position, disassembling condition and so on should be considered. Generally, the larger the load and rotating speed are, the more reliable the bearing is fixed. Meanwhile, inner rings usually use lock nut, tab washer, etc. Outer rings usually adopt the fixtures such as end cover, screwed ring, etc. When the load is smaller and the rotating speed is lower

then inner rings usually use a circlip for the shaft, or adapter sleeve, withdrawal sleeve, etc. Outer rings usually use elastic washer or snap ring. Just like the bearing, many axial fixing devices now use standardized components, such as lock nut, tab washer, circlip, adapter sleeve, withdrawal sleeve, etc. Therefore, customers can select them directly.

9.4 Bearing Preload

Rolling bearings usually retain some internal clearance while in operation. In some cases, however, it is desirable to provide a negative clearance to keep them internally stressed. This is called "preload".

9.4.1 Purpose of Preload

The purpose of preload is:

- To enhance the stiffness of the bearing
- To maintain the shaft in exact position both radially and axially and to increase running accuracy
- To decrease noise and vibration
- To provide the minimum load to prevent bearing from auto rotating and slipping
- To ensure the correct contact position between the rolling elements and inner & outer raceway
- To compensate for the dimension consuming of components in operating

9.4.2 Preload Mode

Depending on the direction of the preload, the preload can be divided into radial or axial preload.

- Deep groove ball bearing can be axially preloaded
- Angular contact ball bearing and taper roller bearing can be axially preloaded
- Cylindrical roller bearings can be radially preloaded because of the design structure
- Thrust ball bearing and thrust cylindrical roller bearing only can be axially preloaded

The method of imposing axial preload on the bearing is to impose axial load between two bearings face to face which make the corresponding axial displacement appear between inner and outer ring. It can be divided into location preload and constant-pressure preload.

9.4.2.1 Position Preload

Position preload is achieved by adjusting the length of sleeve or the thickness of washer to impose axial load on the bearing.

Angular contact ball bearings arranged in pairs are usually ground a certain amount of pre-deflection

δ_{ao} off the inner or outer ring faces, when bearings are mounted, two bearings are in the preloaded state after mating faces are clamped by clamping device, see Fig 9.6.

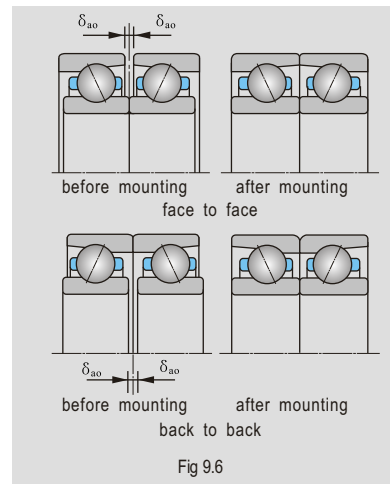

If the two bearings are kept a distance and their faces are not mated, the bearings can be preloaded by spacer sleeve and the necessary amount of preload can be obtained by adjusting the width of spacer sleeve, Fig 9.7.

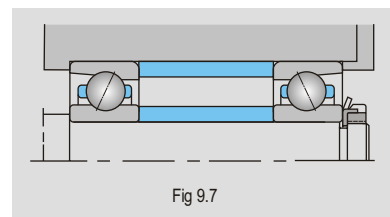

When two angular contact ball bearings arranged face-to-face or back-to-back are in-pair mounted, their axial loads and deflection curves are shown in Fig 9.8. The intersection of the two curves shows that preloading deflection of two bearings are δ_{ao} under preloading loads F_{ao} . When external axial loads F_a are applied on the shaft, the shaft will move displacement δ_a along the direction of F_a . At the same time deflection of bearing I δ_{aI} , while that deflection of bearing II decreases δ_a . Deflection amount shows the following respectively.

$$\delta_{aI} = \delta_{ao} + \delta_a$$

$$\delta_{aII} = \delta_{ao} - \delta_a$$

corresponding axial loads are:

$$F_{aI} = F_{ao} + \Delta F_{aI}$$

$$F_{aII} = F_{ao} + \Delta F_{aII}$$

from the equilibrium of forces:

$$F_a = F_{aI} - F_{aII}$$

It can be seen that axial displacement of supporting system is only δ_a under the axial load F_a . Therefore, mounted angular contact ball bearings arranged in pairs can increase the stiffness of supporting system greatly by preload.

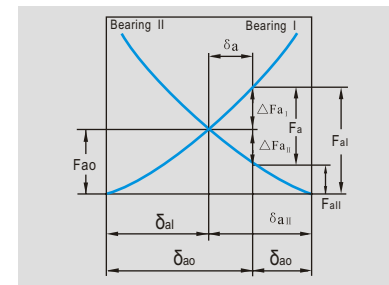

Fig 9.8

When two single row tapered roller bearings are mounted in pairs, their axial loads and deflection curves are shown in Fig 9.9. It can be seen that the stiffness of mounted tapered roller bearings in pairs may be increased by two times.

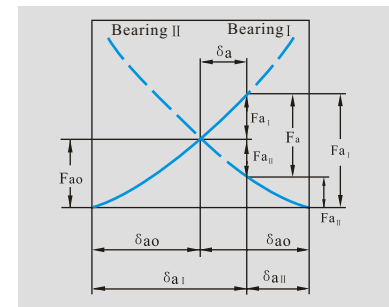

Fig 9.9

9.4.2.2 Constant-Pressure Preload

A constant-pressure preload is achieved using a coil or leaf spring to impose a constant preload. A certain preload can be obtained by adjusting the compression value of the spring, Fig 9.10 is an example of application.

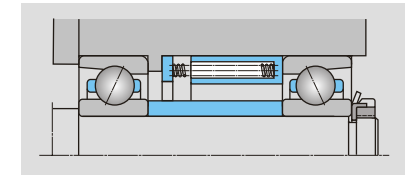

Fig 9.10

Fig 9.11 shows the axial load and deflection curve of an angular contact ball bearing arranged in pairs under constant-pressure preload.

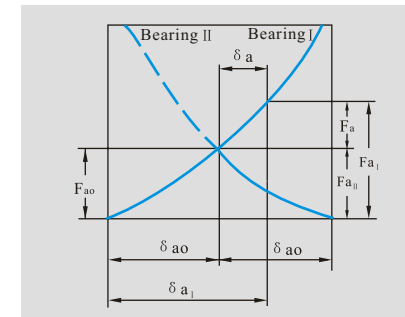

Fig 9.11

Under external axial load, deflection of the bearing I will increase δ_a , and deflection and preload of bearing II will keep constant. Compared with constant-pressure preload, under the same pre-deflection, position preload increases axial stiffness of supporting system. Length differences caused by temperature difference between the shaft and the bearing housing, and radial expansion caused by temperature difference between the inner and outer rings can effect the pre-deflection amount. Under constant-pressure preload they have no effect on the pre-deflection amount at all. Selecting the preload method should be dependant on actual applications. Generally, position preload should be selected in high stiffness constant-pressure, high speed applications.

You can consult the load under the different work conditions from LYC technical department.

10. Lubrication

10.1 Purpose of Lubrication

To make bearing operate effectively and reliably, enough lubrication is necessary. The purposes of lubrication are:

- To prevent or reduce friction and wear by the direct contact among rolling elements, raceways and cages.
- To form an oil film on the friction surface and enlarge the contacted loading area of components.
Therefore, it can reduce contact stress and prolonging rolling contact life.
- To prevent against rust and corrosion.
- To dissipate heat and carry off the worn particles generated in operation or contamination ingress.
- To improve tightness so as to prevent the contamination entering
- To reduce noise and vibration.

10.2 Lubricant Selection

The lubrication can be divided into grease lubrication and oil lubrication. Solid lubrication can

also be chosen under some special conditions. When selecting lubricants, it could be comprehensively considered according to factors such as the structure of machinery, the working conditions of bearings and the structure, lubricating method and maintaining of adjacent components of bearings etc. The factors which should be considered for the selection of oil lubrication or grease lubrication are listed in Table 10.1.

It is essential to maintain sufficient lubrication in any bearing application, so as to avoid seizure. In most applications this is performed by the insertion of either oil or grease between the rolling elements and the raceways. Filling the bearing with lubrication is calculated as a percentage of the available space, this space should not be filled beyond the calculated percentage of the available space, any overfilling can result in overheating, with the net result being premature bearing failure. The selection of the lubrication method and the lubrication itself is dependent on many factors; these factors are described more details in Table 10.1.

Table 10.1

Lubrication Characteristics	Oil Lubrication	Grease Lubrication
Liquid power lubricity	excellent	ok
Borderline lubricity	bad~excellent	bad~excellent
Cooling	very good	bad
Frictional behavior	ok~good	ok
Capability of supplying to bearing	good	ok
Absorbability	bad	good
Leakproofness	bad	very good
Anticorrosive property(to air)	ok~excellent	Good~excellent
Working temperature	generally, it can be used at 90°C (the bulk temperature of oil) or 200°C (the temperature of bearing); it can be used at 250°C by adopting special lubricant oil.	generally, it can be used below the temperature 120°C. however, it can work at 220°C by using special or shorten the cycle of changing grease
Permissible rotating speeds	4.5~5×10 ⁵	3-5×10 ⁵
Permissible load	high	medium
Volatility	very high	low
Flammability	very high~very low	low
Shock resistance	normal	good
Adaptability	very low~medium	medium
Service life	short	long
Cost of lubrication	low~high	quite high
Adjusting the amount of supplied oil or grease	easy	hard
Leakage of lubrication	more	less
Effect on environment	dirty	no affection
The replacement of lubrication	easy	hard
Maintenance	hard	easy
Capability of removing pollution	good	bad
The complexity of designing bracing structures	quite low	quite low
Affection on service life	deterioration or pollution	deterioration

10.3 Grease Lubrication

Considering the structure of the lubrication system, grease lubrication is used in many applications because of its simple sealing structure.

Lubricant grease is a half-solid agent which is made of a base oil, thickening agents and additives. Base oil is about 70-95%, the thickening agent is about 5-30%, and the additive is minimum.

The most widely used lubricating greases are calcium base grease, lithium based grease, calcium-sodium based grease and molybdenum disulfide grease, etc.

The main properties of grease lubrication are shown as the following:

• Base Grease Viscosity

Lubricating properties of lubricants are based on the viscosity of base oil which is important to form lubricant film. Usually, the viscosity of base oil used by rolling bearing is in the range of 15-500mm²/s (40°). If the viscosity is over 500mm² (40°), then the base oil will be very difficult to be dissolved out from the lubricant grease, which, could make the lubrication inadequate. However, if the viscosity is less than 15mm²/s (40°), it will be difficult to form a film.

• Consistency

The ability of resisting deformation under outer force is named consistency. It can be measured with a needle penetrator. The designation of lubricant grease is indicated by the grade of needle penetration. The smaller the needle penetration, the thicker the consistency of lubricant grease is, and worse the liquidity. Needle penetration (or the designation) is divided into nine grades; grade 1, grade 2 and grade 3 are used by bearing. Grade 2 is used most frequently. Generally, greases with light consistency can be used at low temperatures. Greases with high consistency can be used at high temperatures. Its consistency changes little while the grease is used in the range of its normal working temperature. If the working temperature is higher than that allowed, lubricant grease will turn soft and easily leak. Generally, greases which soften at elevated temperatures may leak from the bearing or housing, those which stiffen at a low temperature may restrict the rotation of the bearing.

• Thickening Agent

The main function of thickening agent is to keep lubricant grease in a half-solid state. Therefore, some characteristics such as the working temperature, mechanical stability, heat resistance, and water resistance of lubricant grease are decided by thickening agents. The performance of lubricant grease changes with different thickening agents.

• Additive

Currently base oil is hard to satisfy comprehensive lubrication requirements of friction couples. Therefore, in order to increase the performance of oils, some additives which will improve the quality of oil and must be added into the base oil in order to make greases suitable for various special working conditions. However, lubricant greases added with additives may bring up a negative influence on the bearing parts, such as corrosion.

Types of main additives:

- 1) additives protecting the surface of metal, e.g. extreme pressure additive, etc.
- 2) additives improve the capability of lubrication e.g. adhesive, etc.
- 3) Additives protect the lubricant grease itself, e.g. antioxidant, etc.

• Miscibility

The miscibility of greases with different designations must be considered when changing the designation of greases. Combined lubricant grease with different designations are likely to make the consistency change considerably, which, would cause lubrication failure and leakage. Generally, greases with the same thickening agent and similar base oil can be mixed with each other.

10.3.2 Selection of Grease Lubrication

When selecting lubricant grease, the working temperature, load and rotating speed should be taken into consideration.

The lubricity of grease is largely dependant on base oil, which, is chosen according to the usage and using condition of grease lubrication. Low-viscosity base oil is suitable for bearings which work at low temperatures, light loads, and high speeds. Machine oil and engine oil are suitable as base oil for mid-speed bearings. Cylinder oil is suitable to be used as a base oil for bearings which are operating in high temperature, heavy load and slow-speed conditions. Synthetic base oil can be used in other special conditions.

The structure and precision of the bearing can influence by the selection of lubricant grease. The available space inside the bearing or clearance is

smaller, then the finishing precision on the working surface is higher and the base oil to be chosen would be of less viscosity. This allows for the unnecessary waste of energy. The viscosity value of base oil must be improved when the working surface is rough. Meanwhile, an oil film cannot be formed easily because of the comparably heavy pressure which would be caused by partial contacting.

In watery working conditions, calcium base grease is the first choice because it will not dissolve in water. Sodium base grease will dissolve easily, it should not be used in a dry and hydroponic conditions.

When selecting lubricant grease, attention must be paid to the following several points points:

- Under normal speed, load, and temperature, a minimum movement viscosity of grease used by most kinds of bearings is not less than 15mm²/s.
- The dropping point of the grease should be higher than its working temperature 20-30 °C to avoid leakage.
- Due to bad liquidity, heavy friction resistance, little thermal conductivity of lubricant grease, circle lubrication is inadvisable. If it must be used in the applications where concentrated lubrication is needed, lubricant grease with comparatively large needle penetration should be the first choice.
- In specified range of temperature, grease lubricant is not sensitive to temperature. Grease lubricant has a high adaptability to great changes of load chrematistics and moving speeds, so it can be used in those machineries whose working ambient temperature and speeds change greatly.
- Lubricant grease will not leak easily and need not be changed often. The needed sealing devices are comparatively simple, therefore, the lubricant grease itself has a certain sealing function. So it is suitable to be used in dusty situations where it is difficult to refill greases.
- When lubricating in high temperature, grease with good resistance to oxidation, less evaporation, with a high dropping point should be the first choice.
- For one-off lubricated sealed bearings, the life of lubricant grease should be longer than the fatigue life of bearing. If shorter, then the practical life of bearings is dependant on the life of greases. Generally, the life of lubricant grease is corresponds with the time of medium repair and heavy repair of equipment.

The most widely used lubricating greases are calcium based grease, lithium based grease, aluminum based grease and molybdenum disulfide grease etc.

Sealed bearings listed in this catalogue have been filled with grease before leaving LYC's factory and can be applied directly in service. Generally, the bearings are filled with 2# lithium base grease. If you have other special requirements, please consult LYC technical department.

10.3.3 The Filling Amount of Lubricant Grease

The filling amount of lubricant grease changes with the bearing structure, space, speed, and the type of lubricant grease. The filling amount of lubricant grease is composed of two parts, one is filled inside the bearing, and the other is filled in bearing block.

The filling amount of lubricant grease is confirmed by the ratio of the allowed limiting speed and the practical working speeds when selecting lubricant grease. See Table 10.2

Table 10.2

Rotating Speed Ratio	Filling Amount
$A \leq 1.25$	grease lubrication is 1/3 of bearing free space
$1.25 < A \leq 5$	grease lubrication is 1/3 -2/3 of bearing free space
$A > 5$	grease lubrication is above 1/3 of bearing free space

Table 10.2 only shows the filling amount inside the bearing, but, bearings are often fixed in the bearing block, in order to prevent lubricant grease from leaking out. When the bearing is operating, enough lubricant grease inside the bearings has to be kept to satisfy the need of lubrication. The free space in the bearing block is filled with a certain amount of lubricant grease (except sealed bearing). According to our experience, 1/3-1/2 of the free space in the bearing block should be filled.

The amount should be reduced when the bearing is operating at high speeds. alternatively, the amount is increased.

10.3.4 The Subrogation Cycle of Lubricant Grease

The subrogation cycle of lubricant grease is not only based on the property and character of itself, but, also the lubricant working condition, temperature, speed, and load.

When the temperature is getting higher, the base oil of lubricant grease would be vaporized,

oxidative deteriorated, the grease net structure destroyed and indurate, which, would reduce the capability of lubricant grease. When base oil loses are 50-60%, especially under high temperature, the capability of lubrication descends more quickly. The higher the temperature is, the shorter the life of grease is. Accordingly, replace the old lubricant grease before the capability of the lubricating lost. For the widely used lubricant grease, we judge the grease whether it loses its efficacy or not by examining the function parameter of the grease. See Fig 10.3

Table 10.3

Item	Index
Change of consistency	> 15%
Change of dropping oil	> 20%
Acid number	> 3mg
Lubricant grease leaking	> 50%
Oil separation percent	> 40%
Mechanism impurity	iron > 0.1% copper > 0.3%

• Re-Lubrication Quantity

When the subrogation cycle of lubricant grease is corresponding to the checking period of machines, new grease with the same amount filled in the new bearings should be filled in the cleaned and washed old bearings. While cleaning, please do not destroy bearings, and do not allow any impurity into the bearings. Meanwhile, the bearing block should also be washed too.

Sometimes when the machine is not up to maintenance period, but the lubricant grease requires to be replaced. In this condition, the new lubricant grease have to be filled regularly before the time of machine maintenance. The quality of relubrication should be restricted according to the relubrication period. Normally, the shorter on this period, the less on quantity refilled. This can be calculated by the following empirical formula

$$m = xDB$$

where

- m – the new filled lubricant grease amount each time
- D – bearing outer diameter, mm
- B – bearing inner diameter, mm
- X – modulus of the grease newly filled, see Fig 10.4

Table 10.4

X	0.001	0.002	0.003	0.004	0.005
Lubricating periods	every day	every week	every month	every year	every 2-3 year

There are exceptions as to when the calculated available space may be exceeded, typically when there are large amounts of available free space, or when the bearing operates at low speed. If the bearing is to be operated in an extraneous environmental condition and to prevent the ingress of contaminants. When regreasing it is essential to purge the used grease and ensure that fresh grease reaches all working surface of the bearing, marginally more grease may be applied to make up for premature grease loss and/or evaporation.

10.4 Oil Lubrication

Oil lubrication is recommended in the following situations

- when bearing works at high speeds and high temperatures
- when the frictional or applied heat has to be removed from the bearing
- when lubricant grease can't satisfy the needs
- when abutting machines adopt oil lubrication

10.4.1 Oil Lubrication Modes

• Drip Feed Lubrication

Drip feed lubrication is a method of dripping oil into bearings by a serving oiling orifice. The strong points of drip feed lubrication are that the device structure is simple, it can be used conveniently, more oil can be saved by this way. The amount of oil supplied can be measured and adjusted. A drop should be provided at intervals of 3-8 seconds. Too much oil may cause the temperature to rise. Drip oil lubrication is suitable for slow speed and light load.

• Oil Bath Lubrication

Oil bath lubrication is a method that allows of bearing into lubricant oil to be picked up by rotating elements, after circulating through the bearing, it drains back to the oil bath. See Fig 10.1. Oil bath lubrication is one of the most widely and conveniently used lubrication methods.

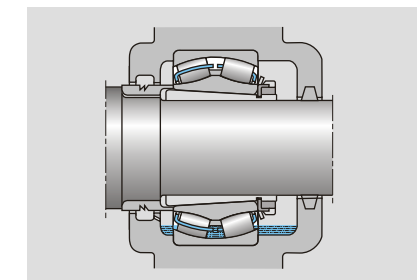

Fig 10.1

Oil bath lubrication can lubricate well, but the quantity of oil supplied is not accommodated easily; and there is no filtration equipment, which would bring impurities into the bearing easily and cause damages to the inside of the bearings. Oil bath lubrication is only suitable for low or medium speeds.

• Splash Lubrication

Splash lubrication is a lubricating system where the oil is induced into the bearing by a splashing motion created by the movement of the bearings rotating elements. See Fig 10.2.

The quantity of oil supplied by this splash motion is not easily controlled. Once again it is essential to maintain any pre-subscribed oil level, as over filling can also be detrimental, the results of over filling can lead to elevated temperatures, these elevated temperatures under heating and cooling can create a vacuum resulting in the possibility of the ingress of contaminants.

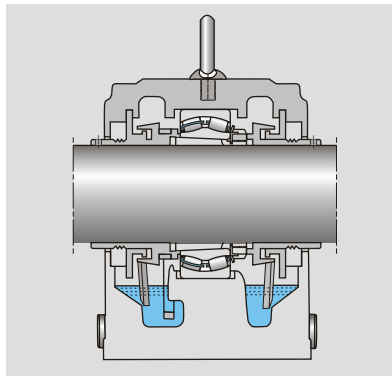

Fig 10.2

• Circulating Oil Lubrication

Lubricant oil can be sucked out by an oil pump from an oil box, then it is transported to the parts in the bearing requiring lubrication, then it is returned to oil box from an oil jaw. The sucked oil can be used again after filtration. See Fig 10.3.

The circulation oil method is a superior system to all other lubrication methods as temperatures can be controlled by additional cooling injection; filtration can be applied to filter out contaminants. When applicable oil monitoring can be applied to that oil replacement is made automatically. Regulated flow is easily adjusted for optimum performance. These regulated flows can be matched to high speeds and high loads. These types of system are not suited for all applications and have the disadvantage of generally being

expensive, however they do provide optimum performance.

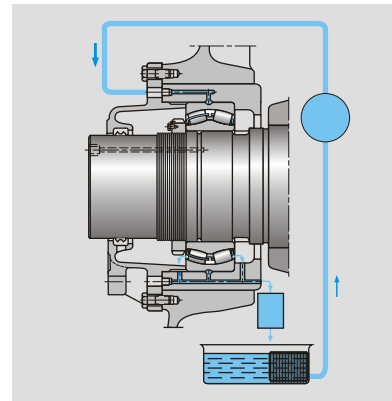

Fig 10.3

• Oil Mist Lubrication

Oil mist lubrication employs oil droplets which are transported to the bearing by an air current (see Fig 10.4), oil mist is produced in an atomizer. Dry compressed air and oil mixture are transported to every part of bearing where it needs lubrication. Oil mist lubrication allows little whisking wastage and temperature rise. Therefore, the air current in the housing will also serve to cool the bearing and produce a slightly higher temperature in the housing to assist in preventing impurities from entering. However, the cost of oil mist lubrication is high, there are some special requirement on the oil viscosity, generally, the viscosity of the oil is no more than 340mm²/s, otherwise, the effect cannot be made. Additionally, if the lubricating device does not seal well and tightly, some oil mist may leak out and pollute the environment. If necessary, oil and gas separators can be used to collect oil mist. This method is often used for high speed applications.

• Oil Jet Lubrication

Oil jet lubrication is a method that is adapted to jet oil into the bearings. See Fig 10.5

When the bearing is operating at a high speed, rolling elements and cages are also rotating at high speed. By this way, turbulence air is formed around the bearing, which can make the lubricant oil reach the parts that needs to be lubricated. However, after the oil is sprayed out, the lubricating oil will flow back into the oil bath from the side because of centrifugal force. In order to provide adequate oil for fast rotating bearings, lubricant oil must be jetted out from the other side.

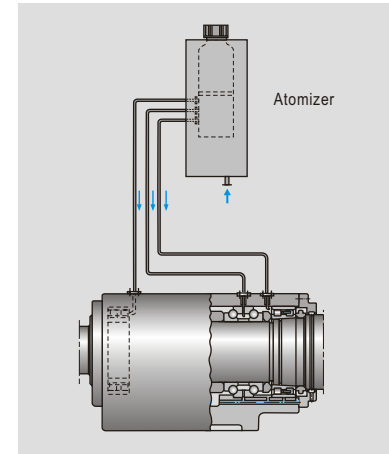

Fig 10.4

When designing this lubricating system, the position of the high pressure standard nozzle should be placed between the inner ring and cage. By centrifugal effect, lubricant oil must be thrown out of the outer raceway. In order to keep the lubrication efficient, the jetting speed should not be less than 15m/s.

No matter which way it is to be used, the cleanliness of the lubricant oil or greases should be considered first, thus ensuring and lengthening bearing life.

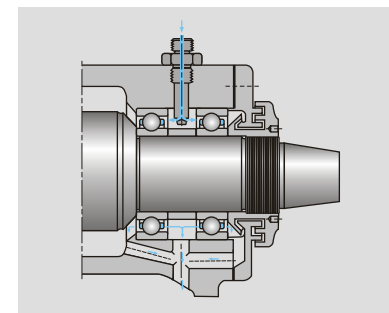

Fig 10.5

• 10.4.2 Lubricant Selection

Lubricant selection is almost the same as the grease lubrication selection. It is mainly based on the viscosity of oil which can provide enough lubrication to the bearing at working temperatures. Lubrication viscosity would fall with the increase of temperature. Therefore the lowest oil viscosity would be ensured at working temperatures. In

normal working conditions, the lowest movement viscosity should not be over 15mm²/s in order to form a lubrication oil layer with enough thickness on the contact surface between raceway and rolling element.

Mineral oil without any additive could be used in normal conditions. The lubrication with additive or compound oil is suitable for special working conditions. However, lubrication with additive would have a negative effect on the bearing, typically corrosion.

Generally speaking, when the bearing is rotating at high speed, the lubricant with a low viscosity could be used. For the bearing under heavy load, lubrication with a high viscosity should be chosen. The widely used lubricants are machine oil, high-speed machine oil, stream-turbine oil, compressor oil, transformer oil, and cylinder oil, etc.

• 10.4.3 Replacing Intervals

In order to ensure that the bearings lubrication is maintained good working condition, lubrications should be replaced regularly, even when oil lubrication systems are adopted.

The replacement intervals for lubricants are dependent on working conditions, environmental conditions, oil mass, oil pollution and the type lubricant. Only careful monitoring of the lubricants condition can determine as to when to change the lubricant, after time a trend can be developed in order to establish a maintenance interval, premature oil changes can be wasteful in down time and expensive in purchasing, whilst there could be additional lubricating life remaining within the existing lubricant.

When adopting Circulating Oil Lubrication, Oil Bath Lubrication, Splash Feed Lubrication, Oil Spray Lubrication, or small lubrication systems with oil deposits below 250 litres, then replacing oil at predetermined intervals should be referred to in Fig 10.5 Circulating Oil Lubrication.

For lubrication systems with capacities larger than 250 litres, then the oil replacement interval should be ensured by periodically checking chemical characteristics, in addition to content of mechanical impurities, refer to Table 10.6 below. When lubricating by Gas Oil Lubrication, the lubricant itself disposable or can be recycled to avoid environmental pollution.

Table 10.5

Lubricating System	Oil Bath Lubrication	Circulating Lubrication		
		Working temperature	Change period	
Working temperature	~70	~50	50~70	>70
Change period	one year	2~3year	one year	3 months

Table 10.6

Item	Precision Machine	Normal Machine
Change of viscosity	± 10%	± 15%
Acid increasing	< 15%	< 25%
Flash point change	< 10%	< 15%
Solidifying point(ascended)	< 10%	< 15%
Moisture content(within oil)	< 1%	< 2%
Mechanism impurity	< 0. 1%	< 0. 2%
Anti-emulsification(ascended)	< 15%	< 20%

For lubrication systems with capacities larger than 250 litres, then the oil replacement interval should be ensured by periodically checking chemical characteristics, in addition to content of mechanical impurities, refer to Table 10.6 below. When lubricating by Gas Oil Lubrication, the lubricant itself disposable or can be recycled to avoid environmental pollution.

10.5 Solid Lubrication

When neither oil or grease lubrication are able to satisfied some special working conditions then solid lubrication can be adopted. An example of this is in the use of bearings for ceramic roasting ovens or where in a application that temperature would exceed 270 centidegree. Other typical applications could be used in bearings for satellite facilities.

Solid Lubricants have the advantage of avoiding pollution as opposed to using oil or grease. Solid Lubricants require less on going maintenance. However, solid lubricants powder characteristics do have a higher coefficient of friction factor, there is no cooling benefit and working life is generally shorter.

Commonly used solid lubricants for rolling bearings are Lead, Silver, Black Lead, Supramoly, Lead Oxide, Polyfluortetraethylene, and nylon etc.

11. Seals

Seals for bearing arrangements are used to prevent dust, contaminant or moisture from entering the bearing and to retain the lubricant in the bearing. The efficiency of the sealing arrangement has a decisive effect on the lubricant cleanliness, the performance and the operational life of a bearing.

There are two types of seals: the distinction is made between seals which are integral with the bearing and those that are positioned outside the bearing. The former is sealed well before leaving the factory.

There are many types of seals positioned outside the bearing, according to the configuration relationships between sealing arrangements and bearings, they can be divided into non-rubbing seals and rubbing seals. In the selection of seals, the following should be considered:

- Working environment of bearings
- Rotating speed of the bearings
- Structure characteristics of the bearing with its matching parts
- Type of lubricant
- Working temperature of the bearing
- Space and position
- Cost

11.1 Noncontact Seals

The effectiveness of noncontact seals mainly depends on a certain clearance between sealing arrangements and bearings without direct contact. Because of clearance, except some lubricant friction in clearance, other types of frictions will not appear. Therefore, the wear as well as the frictional heat will not appear, the seals life will be relatively longer. If the clearance is selected inappropriately, it will be easily affected by the external contamination or moisture and cause the lubricant to be lost. Noncontact seals are suitable for high speeds and high requirement on working temperature.

According to the different positions of clearance configuration, noncontact seals can be arranged axially, radially, or axially and radially in combination. Considering some factors such as operating errors, shaft deformation, the dimensions of clearance are shown in Table 11.1 and typical examples are shown in Table 11.2.

Table 11.1

Journal	Radial Clearance	Axial Clearance
< 50	0. 1~0. 3	1~2
≥50	0. 5~1. 0	3~5

11.2 Contact Seals

Contact seals means existing a certain joint pressure between sealing agreements and bearings by direct contacting. The pressure is generated from the following ways:

- The self-resilience of the seal
- A force exerted by the fit clearance between the sealing arrangement and its counter-face
- A force exerted by a spring in the sealing arrangement

Though contact seals are in need of pressure, under the precondition to meet the using requirements, the pressure should be as low as possible, for the friction moment and working temperature will increase with the growing pressure. The friction moment and working temperature are not only related to the pressure, but, closely related to others such as contact way, dimensional accuracy of the contact site, surface roughness, sliding speed etc.

In addition, all rubbing seals will lead to wearing; its degree is related to environmental pollution, pressure, rotating temperature and speed, lubrication etc. But if the wearing area is lubricated properly, the wear must be reduced.

Because of the frictional heat existing in the contact seals when operating, it's suitable for medium and lower speeds or oil lubrication.

The common structures of rubbing seals are shown in Table 11.3.

In practice, the types of seal can be a combination design according to different working conditions and specific requirements on sealing arrangement. Typical structures are shown in Fig 11.1.

Table 11.2

Types of Seal	Sketches	Examples
Gap types	Narrow gap 	The smaller and longer the length of gap between the shaft and end cover, the more effective will be the sealing effect.
	Helical groove 	There are over three grooves on the end cover. The groove width is 3-4mm, the depth is 4-5mm (the grooves take the shape of helical groove). They are used to fill grease to improve the effect of sealing.
	W-type 	Used for oil lubrication. There is W-groove on the shaft or in the housing. The oil from the flinger is collected in a channel in the housing seal bore and returned to the housing through suitable ducts.
Labyrinths	Radial 	Radial labyrinth passages are composed of the gap between housing and end cover, end cover is separable. Radial labyrinth passages distribute axially, the size in axial direction is compact, the effect of sealing is better. Suitable for dirty environment, e.g. metal-cutting machine.
	Axial 	Axial labyrinth passages are composed of the gap between housing and end cover. Labyrinth passages distribute radially, end cover is one-piece, easy to mount and dismount, wider use than radial labyrinth.
	Combined 	Labyrinth passages are composed of two- "┌" shaped washers, saving space, low cost, suitable for mass production, washer should be mounted combined. The more combination is, the better the effect of sealing is.
Washers	Rotating washer 	Washer is rotating with shaft while working. The higher the rotation of the shaft is, the better the effect of sealing is. The rotating washer can prevent oil from emerging and can also prevent contaminants from entering.
	Stationary washer 	Washer and outer ring of bearing are fixed while working. Used to prevent dirt and contaminants from entering.

Table 11.3

Types of Seal	Sketches	Examples
Felt	Single-felt 	Used for clean lubrication environment. Peripheral speed can not exceed 4-5m/s and working temperature is 90°C. The peripheral speed can reach up to 7-8m/s after the shaft surface is ground. Felt seals can be divided into single-felt, double-felt and multi-felt. To prevent the shaft from wearing early, the sleeve should contact directly with the felt washer. The effect of sealing is not very good, so rarely used.
	Double-felt 	
	Multi-felt 	
Leather cup		Leather cup seal is made of oilproof rubber and suitable for sealing arrangement with grease or oil lubrication. Peripheral speed can not exceed 7m/s and working temperature is not over 100 °C. The sealing lip should be pressured on the surface by a spring. To improve the effect of sealing, two cups can be mounted face to face.
		
		

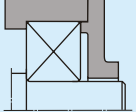
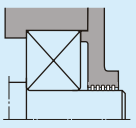
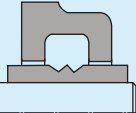
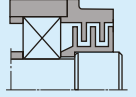
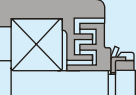
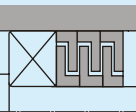
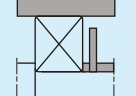
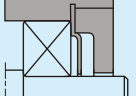
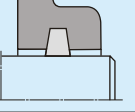
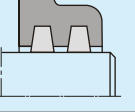
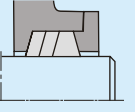
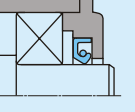
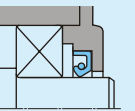
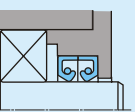
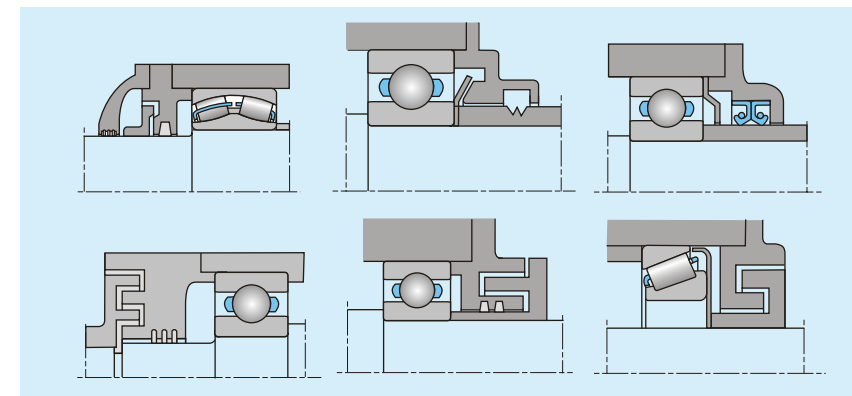

Fig 11.1

12. Package, Transportation and Storage

12.1 Antirust

Bearings are precision manufactured components, during transportation and storage they are susceptible to rusting, consequently LYC take measures to prevent this happening by applying liberal amounts of Anti-rust rust coatings (Anti-corrosive).

12.1.1 Rust-Proof Period

LYC use the China national standard GB/T8597 <Rolling Bearings Antirust Packaging> this standard states that the rust-proof period can be divided into half-year, one-year and two-year periods. Bearings that would be used and installed in a short period are required to have a half-year rust-proof period; standard bearings require a one year rust-proof period; and bearings with a higher use requirement require a two-year rust-proof period.

If bearings are not used during the rust-proof period then they should to be cleaned by removing the original rust preventative then re-coated with anti-rust.

12.1.2 Rust-Proof Material

The most commonly used rust-proof materials are oil (grease) film, emulsifier oil or other water based anti-rust inhibitors, the use of vapor phase inhibitor, and vapor phase anti-rust oil are also acceptable.

Oil film anti-rust oil can be used to anti-rust the bearing in addition to lubrication for the bearing. Bearings using this type oil can be installed directly without cleaning.

Grease film rust-preventive oils include liquid anti-rust grease, solvent-diluting anti-rust oil, and hot petroleum anti-rust grease etc. Solvent diluting anti-rust oil can be sprayed and used easily.

Vapor phase anti-rust oil is a mixture of a vapor phase inhibitor combined into the lubricating oil. This provides lubrication and the anti-corrosion properties. The vapor phase inhibitor is used to prevent moisture within the atmosphere becoming in contact with the metal surface by slow evaporation. It is unnecessary for the vapor phase inhibitor to be in contact directly with the metal. This method of anti-rusting has a very low viscosity and has the ability to penetrate even the smallest cavity, basically being able to ensure 100% coverage for all parts of the bearing. If customers have special requirements so as to avoid any contravention of their local and national standards in respect to environmental concerns with regards to anti-corrosion materials, then they should contact the LYC Technical Department for guidance.

12.2 Packaging

The bearing packaging itself is referred to as inner packaging, outer packaging and promotional packaging. It is important at all times to maintain the integrity of this packaging; the packaging ensures that the bearing will be ready to be put in service when the bearing is required.

12.2.1 Inner Packaging

In order to ensure the effectiveness of the anti-rust coating, the inner packaging is used to prevent the anti-rust from leaking/evaporating during transportation or storage periods. This inner packaging is also used to prevent the anti-rust from being in contact with other external contamination influences.

The following materials are typically used by LYC for inner packaging:

- Polyethylene plastic film, plastic tubes or boxes
- Nylon belt or plastic braid
- Pergamyn paper and Kraft paper
- Polyethylene composite paper
- Cardboard box
- High strength waterproof plastic belt

The type of packaging used to pack bearings depends on the dimensions of bearings. For example,

- The type of packaging used to pack bearings depends on the dimensions of bearings For example.
- Bearings with an outer diameter less than 52mm are normally packed within a plastic tube, or several pieces are rolled together with Polyethylene composite paper.
- Bearings with an outer diameter 52mm~80mm are firstly packed with Polyethylene plastic film piece by piece, several sets are then placed into a specially made carton; or rolled separately with Polyethylene plastic film, the bearings are then rolled in combination sets with Polyethylene plastic film.
- Bearings with an outer diameter 52mm~80mm are packed with Polyethylene plastic film separately; these are then placed into specially made cartons.
- Bearings with an outer diameter over 200mm are normally wrapped with Polyethylene plastic film or Polyethylene composite paper, and then wrapped with a Nylon belt or plastic braid, finally a high strength water-proof plastic belt is wrapped around the bearing to act as a protective cover.

12.2.2 Outer Packaging

The function of the outer packaging once again is to protect these precision components, whilst in transport and storage. Bearings with a diameter of less than 200mm are usually packed in wooden cases; all markings are of China national standards. LYC do promote their own brand labeling on the outer surface of the carton. Customer's can request their own markings to their own international standards, including, if required barcode labeling. LYC manufacture their own packaging. Box sizing and the number of bearings within each box are all calculated, if there is spare space then this is filled with, corrugated paper or foam board etc. It is very important to fill the remaining space in the outer package fully so as to prevent the possibility of fretting, which, could occur during transportation. All wooden cases are bound with metal strips in order to assure the integrity of the carton; the carton is then sealed with scotch tape and Kraft paper tape, this is then bound with a nylon belt.

12.3 Transportation

The quality of the transportation should be equal to the quality of the bearings themselves, as shipments that have been handled inappropriately have the potential for damaging the bearings within the packaging.

LYC design the outer packaging to take into account many factors, such as carrying capacity, durability against shock absorption, handling, and pressure resistance etc., anyone or a combination of these factors can cause damage to the bearings during transportation, these factors are taken seriously by LYC. The loading and unloading of bearings should be reduced to a minimum where possible to reduce the potential for damage. Pallets and containers should be used to transfer any larger-size or heavy bearings. Mechanical handling and auxiliaries should be chosen in order to maximize smooth transition from point A to point B. For small to medium bearings with larger quantities, mechanical handling should also be adopted as described previously. Throwing or tipping over bearings is strictly forbidden. Bearings should always have a smooth transition at any time they are being moved.

Bearings should always be placed in a horizontal orientation. It is forbidden to place any pressure on any bearing so as to avoid deformation. Boxes should be placed together closely; this can help reduce shock and vibration during transportation. If bearings are transported by truck, then the bearing boxes should be affixed firmly with

strapping and covered with a water and dust-proof awning. If bearings are transported by rail, then the boxes should be placed steadily and firmly on the trains. If bearings are transported by vessel, then water and moisture-proof facilities should be adopted.

12.4 Storage

As Bearings are precise mechanical components as compared with general mechanical products, there must be much stricter requirements for their storage environment; otherwise, it would become very easy for bearings to lose their precision or to become rusty.

12.4.1 Requirements of Warehousing

- It is important for warehousing to be structurally sound and preferably to be environmentally controlled. Bearings should not be placed in direct sunlight.
- The relative humidity in the warehouse should be below 80%. If the humidity were higher then it could be very easy for the bearings to become rusty. The temperature of the warehouse should be controlled at $25^{\circ}\text{C} \pm 10^{\circ}\text{C}$, evening temperatures should vary little, large temperature difference can cause condensation, if the RH has been high through the day and there are cooler temperatures through the evening then condensation could form on the bearings, with the net result of them developing rust.
- All warehousing should have a firm concrete base and be free from dust.
- Bearings should not be stored in the same warehouse where there maybe acids, alkalis, salts, or other industrial chemicals which may be corrosive, gasses should also be avoided as in some cases these also may be corrosive to Bearings.

12.4.2 Requirements for Warehousing

- The outer packaging of the bearings should be checked to ensure it is in good order before entering the warehouse. If the seal on the packaging should be found to be damaged, then the carton should be opened immediately and the bearings inspected prior to been stored.
- The main packaging should be opened in any event so as to inspect the bearing quantity, quality, certificates, specifications, and the manufacturer's date of production etc.

12.4.3 Requirements for System Storage

- Bearings having an OD of less than 200 mm should be placed on storage racks in the horizontal position, other bearings can be placed on top of each other providing there is sufficient support between each bearing so as to avoid potential distortion.
- Bearings with an OD exceeding 200 mm should be placed at ground level, with well placed intermediate supports to lift the bearing off the ground for a minimum of 200 mm in height. As a general rule these size bearings should not be stacked above 1.5 metres in height.
- When placing bearings upon each other use caution so as to avoid damage and distortion between each bearing. Bearings should be used on the first in first out system.

12.4.4 General Requirements for Bearing Storage

- The bearings rust proof coating generally has an expiration life of one year. Consideration of minimum stock levels should be given so as to minimum turn in inventory time, once again the first in first out should apply. Dependent on environmental conditions and time exceeding one year then there is the possibility for bearings to lose their tolerance stability.
- Bearing should be placed in store rooms that are environmentally controlled in respect of temperature and humidity, in addition to filtration so as to remove airborne particulates.
- The Bearings inner packaging should not be removed until the bearing is ready to be placed into service, periodically (3 months average) some of the bearings packaging should be removed so that the bearing can be inspected for rust, if rust should be found then this should be removed, the bearing should then be recoated with rust preventative and re-sealed.
- A lot of these types of bearings in storage service should be kept so as to maintain accurate records for bearings in storage.

13. Mounting and Dismounting

13.1 Mounting

Roller Bearings are precision mechanical components with tight dimensional tolerances. Care must be taken when mounting bearings so as to ensure the integrity of the bearing is maintained. Improper mounting can result in poor performance and premature failure.

13.1.1 Preparations Before Mounting

Preparations should be carried out in the following manner prior to mounting as follows:

- Bearings should be mounted in an area that is dry and dust free, avoid areas with chemical contaminants.
- The mounting tools should clean and well maintained so as to avoid any kind of particulates entering the bearing.
- Before mounting, check the components size, shape, position, accuracy and that any chamfers match with bearing. See Fig 13.1. Unqualified components should not be used. Pay attention to all tolerances within the ID, OD of the bearing so as to ensure that tolerances are with the prescribed limits of the mounting apertures, if these are not within the limits then bearing should not be mounted.
- Clean all the suitable and pre-qualified components, and remove sharp burrs.
- Bearings adopting oil lubrication, should have their hydraulic system checked first, this hydraulic equipments filtrating system must work efficiently, and the filtrating accuracy should not be less than 3 micron.
- Bearings should not be unpacked and cleaned, until all preparations for mounting are complete. Bearings lubricated with antirust oil should be cleaned with kerosene (ensure that there is no potential for fire whilst carrying out this operation). If grease with a high viscosity was used to seal the bearing (currently use rarely), then it needs to be dissolved first with a light-weight mineral oil such as NO.10 mechanical oil or transformer oil, its temperature should not exceeding 100°C. After this operation clean with kerosene or appropriate petroleum degreaser. Bearings that are lubricated with the oil provide a double function, namely that of anti-corrosion and lubrication, these can be mounted and used directly without cleaning. Bearings should be mounted as soon as cleaning is completed so as to avoid additional contamination. Bearings that can not be mounted immediately after

cleaning should be placed in a clean area so as to avoid becoming contaminated with moisture or other contaminants. When handling bearings with your hands you should apply some anti-rust to surface of your hands so as to avoid additional contamination.

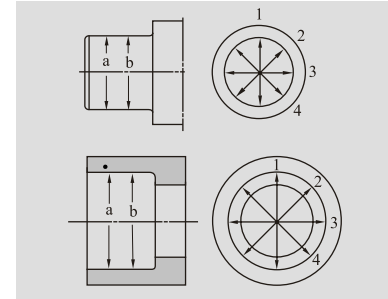

Fig 13.1

13.1.2 Methods of Mounting

There are three main methods for bearing mounting: Pressure Method, Temperature Difference Method and Hydraulic Pressure Method.

• Pressure Method

The pressure mounting (or dismounting) is a method that applies pressure directly without changing the matched components' dimension under a constant temperature condition, see Fig 13.2. This method is commonly used for small and medium size bearings with interference fit that is not so large. Bearings having a large interference fit, large size bearings or components with a weaker rigidity should not adopt this method, so as to avoid deformation.

When adopting this method the end face of the bearing should receive pressure evenly, the alignment between the bearing shaft neck and the housing bore should be kept homocentric so as to

prevent deflection. The pressure should not be allowed to transfer through rolling element and cage as this will damage the surface of the components and have a detrimental effect on the normal operation of the bearing. Knocking the bearing with a hammer directly is prohibited. Pressure is obtained by applying the force to the end face circle evenly by pressing machine. Lubricant can be used to protect the surface, but, excessive use of lubricant will influence the quality of interference fit and can cause slipping. Cautious use of lubricant should be applied with small interference fits.

• Temperature Difference

This method is suitable for the bearing with larger interference or the bearing been mounted and dismounted frequently. This is to make the interference vanish temporarily by heating or freezing, and regain after the temperature is normal so that the bearing can be mounted and dismounted easily.

When adopting this method to mount or dismount, no matter which heating or freezing method be selected, the most important thing is to control the temperature. Too high temperature will cause the change of material, hardness or dimension. While much low temperature may cause the bearing to fracture. Generally, the heating temperature should be 60-70°C lower than the tempering temperature. For the ordinary bearing steel, the highest heating temperature should be below 100°C and the lowest freezing temperature should be above -50°C.

The temperature difference method can be divided into oil bath, air heating, flame heating, electromagnetic induction, etc.

Among them, air heating needs a heat box, electromagnetic induction needs a related device. Air heating can be controlled by the temperature easily. Electromagnetic induction is more suitable for batch mounting of the bearings with same specification. When using flame heating, the

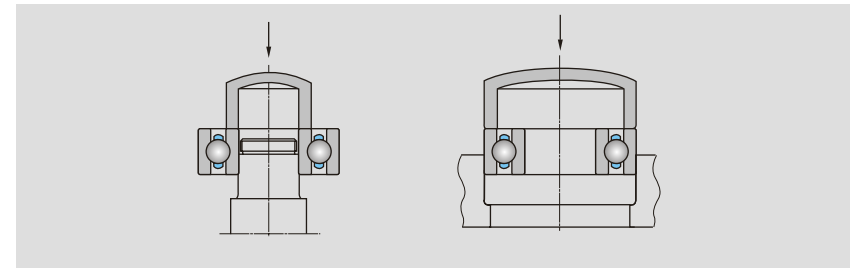

Fig 13.2 Mounting Bearing Under Pressure

distance between flange and component surface should not be too close to prevent the surface from being damaged, equal heating should be done along the circle.

In practice the most commonly heating method is oil heating, this operation is simple without special tools. The heating oil mostly uses non-corrosive mineral oils such as transformer oil with its splash point of 250°C, see Fig 13.3. When oil bath is being exerted, transformer oils are put into the oil groove and a support with bearings on is located at the bottom of the groove with the distance of 60mm. The purpose of this is to heat equally and prevent bearings from polluting. A temperature gauge should be put in the groove to control heating temperature. The oil heating method is not only fit for the mounting of medium and small sized bearings, but, also fit for separable and non-separable bearings.

• **Hydraulic Pressure Method**

Hydraulic pressure is quite an advanced method. Its principle is that the hydraulic oil enters the interference fit place through the preprocessed oil hole and oil groove to form a film ring, then mount or dismount by using tensile force to roll out the

mating surface(see Fig 13.4). However, this method requires higher dimension accuracy, otherwise the oil will leak easily and the high pressure will not appear. The mounting method is shown in Fig 13.4.

13.2 Dismounting

There are two purposes of dismounting: one is for replacement, the other is for inspection or maintenance so as to use the bearing again. For the latter purpose, it should be careful not to damage the bearing. When dismounting the interference fitting ring, the dismounting force is only allowed to act on the ring which is prohibited to pull out by rolling elements. Special tools should be adopted when dismounting.

The dismounting methods are similar to mounting, which are also including pressure (see Fig 13.6), temperature difference, and the hydraulic pressure method (see Fig 13.4) etc. However, the tools are different, for the temperature difference method, electromagnetic induction heating or hot oil pouring bearing parts (for the separable bearing) heating can be adopted, and the parts should be dismounted after heating.

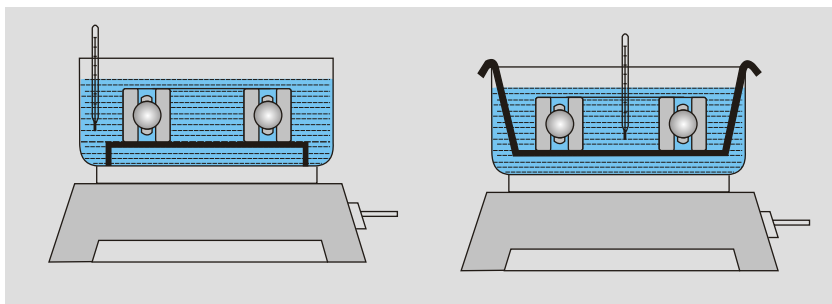

Fig 13.3

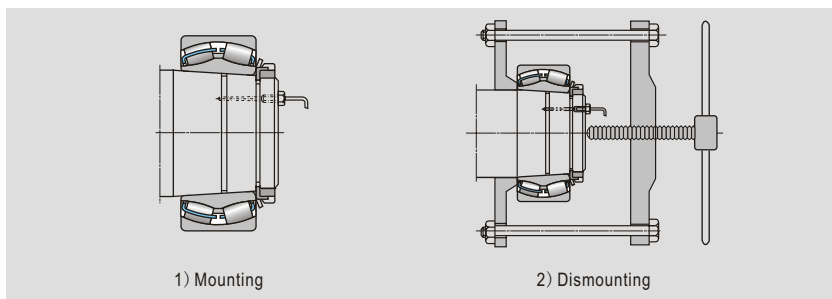

Fig 13.4

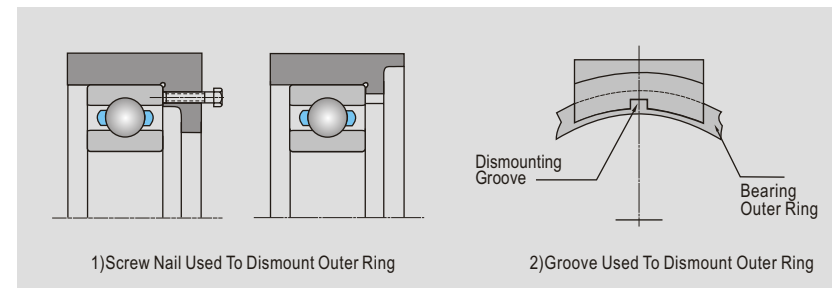

Fig 13.5

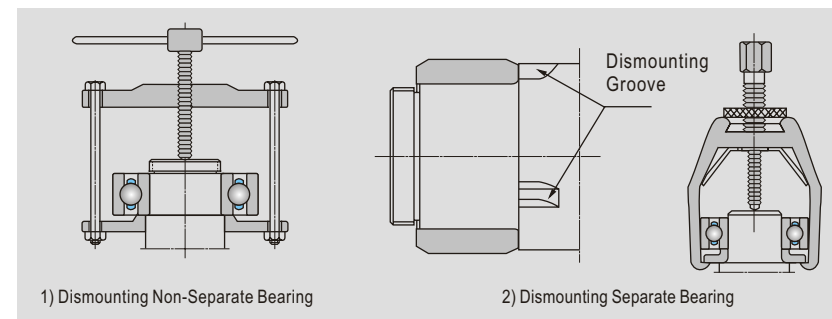



Fig 13.6





Deep Groove Ball Bearings

 101



Deep Groove Ball Bearings

 121

Deep Groove Ball Bearings with a Snap Ring Groove

  127

Deep Groove Ball Bearings with Shield

  133

Deep Groove Ball Bearings with Seals



Deep Groove Ball Bearings

LYC's deep groove ball bearings are one kind of radial bearings widely used. They are simple in structure, non-separable and cheap in price. In addition, they require little maintenance in service, and they are capable to be operated at high speeds.

Both the inner and outer ring of single row deep groove ball bearings have a deep groove raceway, and they are with good sealing quality between raceway and ball. This enable them to carry radial loads as well as certain axial loads. After the radial clearance is increased, the axial load carrying capacity will be improved. This is the reason why they can replace high speed angular contact ball bearings in some cases.

Sealed Bearings

LYC's deep groove ball bearings have various types of structure. Not only the open type bearings are provided, but also the bearings with shield or seal at one side, shields or seals at both sides.

The seal ring can be divided into contact and non-contact (low friction) according to contact ways. Usually the bearings with seals at both sides have been filled with grease lubricant before delivery. The filler amount would be 25%-30% of the effective space in bearings. If customers have special requirements, other types of greases can be filled and the filler amount could be adjusted accordingly.

The bearings sealed at both sides are forbidden to washed. Bearings with seals can maintain their reliable operation at working temperature between -30°C and 100°C.

Contact sealed bearings should not be chosen to use in high speed working conditions, because the friction existing between seal and inner ring of the bearing would make the ambient temperature higher than that of non-contact sealed bearings. As a consequence, contact sealed bearings are suitable for middle or slow speed working conditions.

Deep Groove Ball Bearings with a Snap Ring Groove

Deep groove ball bearings with a snap ring groove can be located by a snap ring. When installing, they can be fastened in the housing by a snap ring. So when the mounting position is limited, a deep groove ball bearing with a snap ring groove would be the first choice.

After a combined design, shields, seals and snap ring groove mentioned above can be provided according to different applications.

Low-Noise Bearings

In order to meet users' special needs of bearings with low noise (or low vibration), LYC can provide users with deep groove ball bearings with different levels of vibration, which are identified by a suffix. This is explained in the chapter of "LYC Bearing Designation".

LYC can provide customers deep groove ball bearings with other structures, such as insulative deep groove ball bearing, ceramic deep groove ball bearing, stainless steel deep groove ball bearing, and a full ball bearing with filling slot etc. All types can not be listed in this catalogue. If customers require other types, then please consult LYC technical department.

Cage

LYC deep groove ball bearings are supplied with a pressed steel cage, a machined solid cage or glass fiber reinforced polyimide 66 and other engineering plastic cages. Cages of different materials are identified by suffix, the designation is explained in the chapter of "LYC Bearing Designation"

Axial Load Carrying Capacity

Generally, if the deep groove ball bearings are need to carry pure axial load, the load can not be over 0.5C0. For bearings with a small size (inner diameter is under 12mm) and light series (the diameter series is 8、9、0 and 1), the axial load can not be over 0.25C0. Extra large axial load would make the bearing life shorten greatly.

Minimum Load

In order to keep bearings working in a good condition, a minimum load must be imposed, particularly on bearings working at high speeds, high accelerations, or with the load direction changing frequently, because under these working conditions, inertial force of balls and cage and lubricant friction will have bad influence on the rotation of bearings, and detrimental sliding movement may be caused.

$$F_{min} = K_r \left(\frac{Vn}{1000} \right)^{\frac{2}{3}} \left(\frac{dm}{1000} \right)^2$$

Where

- V — oil viscosity at operating temperature, mm²/s
- n — speed, r/min
- dm— mean diameter of bearing dm=0.5 (d+D), mm
- Kr— minimum load factor, refer to bearing series as below

Bearing Series					
Kr	618	619, 610	619, 161, 62	63	64
	15	20	25	30	35

When bearings are started at low ambient temperatures or in a condition where the viscosity of lubricant is very high, a larger minimum load probably is required. Usually, the weight of bearing supporting parts plus the load on the bearing have been over the required minimum load. If the weight can not be up to the minimum load, then extra radial load must be imposed on this type of bearing in order to meet the requirement of minimum load. The requirement can be met through axial preloading with springs.

Relative Axial Load		Single Row Bearing				Double-Row Bearing				e
foFa Cor	Fa iZC ² w	Fa Fr ≤ e		Fa Fr > e		Fa Fr ≤ e		Fa Fr > e		
		X	Y	X	Y	X	Y	X	Y	
0.172	0.172				2.3				2.3	0.19
0.345	0.345				1.99				1.99	0.22
0.689	0.689				1.71				1.71	0.26
1.03	1.03				1.55				1.55	0.28
1.38	1.38	1	0	0.56	1.45	1	0	0.56	1.45	0.3
2.07	2.07				1.31				1.31	0.34
3.45	3.45				1.15				1.15	0.38
5.17	5.17				1.04				1.04	0.42
6.89	6.89				1				1	0.44

Equivalent Dynamic Load

Equivalent dynamic load of deep groove ball bearings is not only dependant on the ratio of the axial load and the basic static load rating, but, are also influenced by the magnitude of the radial internal clearance. Increased radial clearance enables axial load carrying capacity to be higher. The equivalent dynamic load of deep groove ball bearings can be calculated as follows

$$\begin{aligned} &\text{when } Fa/Fr \leq e \quad P=Fr \\ &\text{when } Fa/Fr > e \quad P=X \cdot Fr + Y \cdot Fa \end{aligned}$$

where

- P — Equivalent dynamic load, N
- Fa— Axial load, N
- Fr — Radial load, N
- X — Radial load factor
- Y — Axial load factor

Dimension, Tolerance, and Clearance

The boundary dimension of LYC's standard deep groove ball bearings are in according to GB/T273.3 <Rolling Bearing, Radial Bearing, and Boundary Dimension General Specification>, and GB/T276 <Rolling Bearing, Radial Bearing and Boundary Dimensions>

The tolerance of the LYC standard deep groove ball bearing conforms to GB/T307.1 <Rolling Bearing, Radial Bearing and Tolerance>.

The clearance of the LYC standard deep groove ball bearing is according to GB/4604 <Rolling Bearing, Radial Clearance>.

The dimensional tolerance of the LYC standard deep groove ball bearing is usually the normal grade P0 and the clearance is group 0. If customers have other special requirements on dimension, tolerance, and clearance, please consult LYC technical department.

The values of factor e, X and Y are given in the above table.

Equivalent Static Load

The equivalent static load of deep groove ball bearings can be calculated as follows

$$Po=0.6Fr+0.5Fa$$

$$\text{when } Po < Fr \quad Po=Fr$$

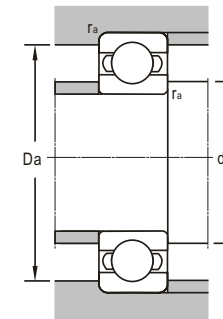
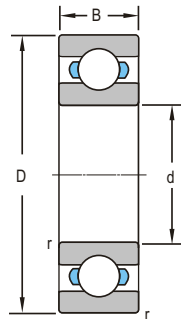

d 10~20mm

Boundary Dimensions				Basic Load Ratings		Limiting Speeds	
d	D	B	r _{min}	Dynamic C	Static C ₀	Grease	Oil
mm				kN		r/min	
10	26	8	0.3	4.58	1.97	30000	36000
	30	9	0.6	6.6	3.1	24000	30000
	35	11	0.6	8.06	3.4	20000	26000
12	28	8	0.3	4.98	2.39	26000	32000
	32	10	0.6	6.89	3.1	22000	28000
	32	10	0.6	6.89	3.1	22000	28000
	37	12	1	9.75	4.15	19000	24000
	42	13	1	10.4	4.63	17000	21000
15	28	7	0.3	4.31	1.94	24000	30000
	32	8	0.3	5.48	2.8	19800	25000
	32	9	0.3	5.48	2.8	22000	28000
	35	11	0.6	7.8	3.75	19000	24000
	35	11	0.6	7.8	3.75	19000	24000
	42	13	1	11.4	5.4	17000	20000
16	35	11	0.6	7.8	3.75	18500	23500
17	35	8	0.3	5.93	3.18	19000	24000
	35	10	0.3	5.93	3.18	19000	24000
	40	12	0.6	9.56	4.75	17000	20000
	40	12	0.6	9.56	4.75	17000	20000
	40	12	0.6	9.56	4.75	17000	20000
	42	13	0.6	9.56	4.75	16300	19000
	47	14	1	13.5	6.5	15500	18000
19	35	8	0.3	6	3.29	18500	23000
20	42	8	0.3	6.91	3.97	17000	20000
	42	12	0.6	9.17	4.9	17000	20000
	47	14	1	12.7	6.5	15000	18000
	47	14	1	12.7	6.5	15000	18000
	47	14	1	12.7	6.5	15000	18000
	47	14	1	12.7	6.5	15000	18000
	47	14	1	12.7	6.5	15000	18000
	47	15	1	12.7	6.5	15000	18000
	47	15	1	12.7	6.5	15000	18000
	52	15	1.1	18.2	10.2	13000	16000
	55	15	1.1	18.2	10.2	13000	16000

Bearing Designations		Mounting Dimensions			Mass
Present	Original	d _{amin}	D _a _{max}	r _a _{max}	
		mm			kg
6000E	100E	12	24	0.3	0.0188
6200E	200E	14	26	0.6	0.0311
6300E	300E	14	31	0.6	0.053
6001E	101E	14	26	0.3	0.0206
6201E	201E	16	28	0.6	0.0356
6201E/YA	201EK1	16	28	0.6	0.0324
6301E	301E	17	32	1	0.058
401TN1	370401	17	37	1	0.098
61902E	1000902E	17	26	0.3	0.015
16002E	7000102E	17	30	0.3	0.0274
6002E	102E	17	30	0.3	0.0304
6202E	202E	19	31	0.6	0.0428
6202E/YA	202EK1	19	31	0.6	0.0371
6302E	302E	20	37	1	0.0811
6202E/YA2		20	31	0.6	0.041
16003E	7000103E	19	33	0.3	0.0311
6003E	103E	19	33	0.3	0.0382
6203E	203E	21	36	0.6	0.0663
6203E/YA	203EK1	21	36	0.6	0.062
6203E/C9	203EU	21	36	0.6	0.0663
6203 X3		21	38	0.6	0.0831
6203 X1		21	38	0.6	0.0784
6303E	303E	22	42	1	0.11
66/19E		21	33	0.3	0.0285
16004	7000104E	22	40	0.3	0.0486
6004E	104E	24	38	0.6	0.0686
6204E	204E	25	42	1	0.105
6204ETN1		25	42	1	0.102
6204E/YA	204EK1	25	42	1	0.0996
6204E/C9		25	42	1	0.105
6204E/C9YB2		25	42	1	0.105
6204X2/C3YA4	V204S-C3	25	42	1	0.112
6204X2TN1/C3YA4	V204AS-C3	25	42	1	0.109
6304E	304E	26.5	45.5	1	0.144
6304EX1		26.5	45.5	1	0.173

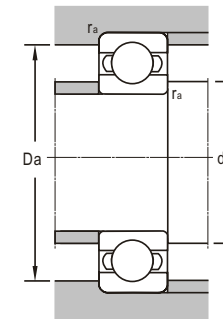
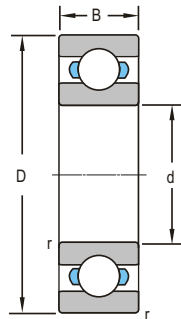

d 22~35mm

d	Boundary Dimensions			Basic Load Ratings		Limiting Speeds	
	D	B	r _{min}	Dynamic C	Static C ₀	Grease	Oil
mm				kN		r/min	
22	42	8	0.3	6.91	3.97	15100	19100
	50	14	1	14.5	9.28	13000	16000
	56	16	1.1	18	10.5	12000	15000
25	42	9	0.3	9.55	4.6	14500	18300
	42	9	0.3	7.03	4.53	14500	18300
	47	12	0.6	11	6.42	15000	18000
	47	15	0.6	10.1	4.96	15000	18000
	52	12	0.6	15.2	8.05	12000	15000
	52	13	1	15.1	8.9	12000	15000
	52	15	1	15.1	8.9	12000	15000
	52	15	1	15.1	8.9	12000	15000
	52	15	1	15.1	8.9	12000	15000
	52	15	1	15.1	8.9	12000	15000
	52	9	1	14	7.8	12000	15000
	52	9	0.3	14	7.8	12000	15000
	62	17	1.1	22.5	11.6	11000	14000
	62	17	1.1	22.5	11.6	11000	14000
	62	12	0.6	22.5	11.6	11000	14000
62	16	0.6	22.5	11.6	11000	14000	
80	21	1.5	37.2	18.8	9000	11000	
28	58	16	1	16.5	9.65	11000	14000
	68	18	1.1	33.5	14.2	9500	12000
30	42	7	0.3	4	3.15	14000	19000
	55	13	1	13	8.15	12000	15000
	62	10	0.6	19.5	11.2	10000	13000
	62	16	1	19.5	11.2	10000	13000
	72	19	0.2	26.7	15	7500	
	72	19	1.1	28.1	16	9000	11000
	72	19	1.1	28.1	16	9000	11000
	72	19	1.1	28.1	16	9000	11000
	90	23	1.5	44.6	23	8300	10000
32	65	16	1	19.5	11.2	10500	13000
	65	16	0.6	23.5	13.1	10500	13000
35	47	7	0.3	4.02	3.28	11500	15000
	62	14	1	16.5	10.5	10000	13000
	72	17	1.1	25.5	15.3	9000	11000

Bearing Designations		Mounting Dimensions			Mass
Present	Original	d _{amin}	D _a _{max}	r _a _{max}	
		mm			kg
160/22X1		24	40	0.6	0.0441
62/22 E		27	45	1	0.117
63/22E		28.5	46.5	1	0.177
61905E	1000905E	27	40	0.3	0.0424
		27	40	0.3	0.0441
6005E	105E	29	43	0.6	0.0794
6005 X2/C3YA4	V005S-C3	30	42	1	0.0964
6205EX2TN1/C4	SR205C4	29	48	0.6	0.1
6205 X2/C9		30	47	1	0.111
6205E	205E	30	47	1	0.129
6205ETN1	205EA	30	47	1	0.121
6205E/C3YB2		30	47	1	0.129
6205E/YA5		30	47	1	0.134
6205 X2		30	47	1	0.0859
		27	50	0.3	0.0824
6305E	305E	31.5	55.5	1	0.22
6305E/YA	305EK1	31.5	55.5	1	0.209
68305		29	58	0.6	0.18
6305EX2		29	58	0.6	0.217
6405E	405E	33	72	1.5	0.53
62/28E		33	53	1	0.162
63/28E		34.5	61.5	1	0.292
61806		32	40	0.3	0.0255
6006E		35	50	1	0.113
6206EX2	106E	34	58	0.6	0.188
6206E	206E	35	57	1	0.2
6306E-2ZTN1/p64Z2YA		36.5	65.5	0.2	0.343
6306E	306E	36.5	65.5	1	0.349
6306E/YA	306EK1	36.5	65.5	1	0.334
6306EQ1	306EQ	36.5	65.5	1	0.41
6406E	406E	38	82	1.5	0.715
62/32X3		37	60	1	0.197
62/32EX2		36	61	0.6	0.211
61807/P4		37	45	0.3	0.0289
6007E	107	40	57	1	0.149
6207E	207E	41.5	65.5	1	0.284

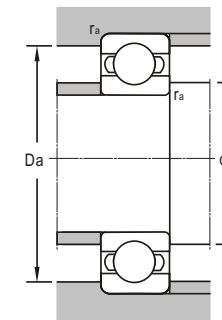
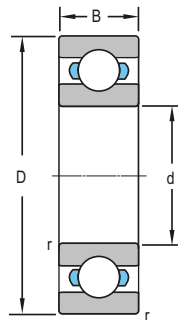

d 35~55mm

Boundary Dimensions				Basic Load Ratings		Limiting Speeds	
d	D	B	r _{min}	Dynamic C	Static C ₀	Grease	Oil
mm				kN		r/min	
35	72	17	1.1	25.5	15.3	9000	11000
	72	17	1.1	25.5	15.3	9000	11000
	80	21	1.5	33.5	19.3	8500	10000
	80	21	1.5	33.5	19.3	8500	10000
	100	25	1.5	55.3	31	7000	8500
40	100	25	1.5	55.3	31	7000	8500
	68	15	1	21.8	11.6	9200	11600
	80	18	1.1	30.1	18.6	8200	9700
	80	18	1.1	30.1	18.6	8200	9700
	90	23	1.5	41.2	24.3	7300	8700
41	90	23	1.5	39.8	23.3	7300	8700
	90	23	1.5	39.8	23.3	7300	8700
	110	27	2	67.8	36.4	6500	7800
43	80	17	1.1	32.6	19.8	8400	9900
	85	17.2	1	36.4	22.6	7800	9300
45	75	16	1	21	14.9	8300	10500
	75	16	1	20.9	15.2	8300	10500
	85	19	1.1	33.2	21	7500	8700
	85	19	1.1	33.2	21	7500	8700
	85	19	1.1	33.2	21	7500	8700
	85	19	1.1	33.2	21.3	7500	8700
	100	25	1.5	52.7	30.5	6500	7800
	100	25	1.5	52.7	30.5	6500	7800
	120	29	2	78.4	46.3	5800	6800
	120	29	2	91	57.8	5800	6800
50	80	16	1	22	16.2	8000	9700
	90	20	1.1	35.4	23.3	6800	8200
	90	30.2	1.1	34.4	22.7	6800	8200
	110	27	2	61.8	37.9	6100	7300
	110	27	2	61.8	37.9	6100	7300
	110	27	2	80.9	56.6	6100	7300
	130	31	2.1	92.5	55.2	5100	6100
55	90	18	1.1	31.9	22	6800	8700
	100	21	1.5	43.3	28.1	6100	7300
	100	21	1.5	43.3	28.1	6100	7300

Bearing Designations		Mounting Dimensions			Mass
Present	Original	d _{amin}	D _a _{max}	r _a _{max}	kg
		mm			kg
6207EQ4		41.5	65.5	1	0.338
6207E/C3YB2		41.5	65.5	1	0.284
6307E	307E	43	72	1.5	0.462
6307E/YA	307EK1	43	72	1.5	0.452
6407E	407E	43	92	1.5	0.922
6407E-2Z		43	92	1.5	0.99
6008E	108	45	63	1	0.185
6208E	208E	46.5	73.5	1	0.36
6208E/YA	208EK1	46.5	73.5	1	0.333
6308E	308E	48	82	1.5	0.609
6308E/YA	308EK1	48	82	1.5	0.588
6308EQ1	308EQ	48	82	1.5	0.764
6408E	408E	49	101	2	1.17
62/41X/C3		48	73	1	0.338
CC-62/43		48.8	79.2	1	0.394
6009E	109E	50	70	1	0.236
6009E/YA/P53V2		50	69.2	1	0.243
6209E	209E	51.5	78.5	1	0.408
6209E/YA	209EK1	51.5	78.5	1	0.385
6209EQ1	209EQ1	51.5	78.5	1	0.511
6209E/YA5		51.5	78.5	1	0.416
6309E	309E	53	92	1.5	0.839
6309E/YA	309EK1	53	92	1.5	0.818
6409E	409E	54	111	2	1.57
6409E/YA4	70409	54	111	2	1.63
6010E	110E	55	75	1	0.252
6210E	210E	56.5	83.5	1	0.463
63210	3000210	56.5	83.5	1	0.681
6310E	310E	59	101	2	1.06
6310EQ1		59	101	2	1.32
310J	370310	59	101	2	1.16
6410	410	61	119	2	1.87
6011E	111E	61.5	83.5	1	0.365
6211E	211E	63	92	1.5	0.605
		63	92	1.5	0.602

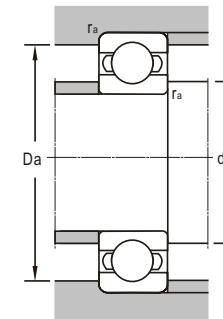
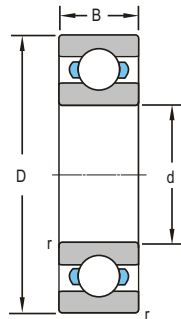

d 55~85mm

Boundary Dimensions				Basic Load Ratings		Limiting Speeds	
d	D	B	r _{min}	Dynamic C	Static C ₀	Grease	Oil
mm				kN		r/min	
55	120	29	2	71.5	44.6	5400	6500
	120	29	2	71.5	44.6	5400	6500
	120	29	2	71.5	44.6	5400	6500
	140	33	2.1	101	62.4	4800	5800
56	120	28.7	2	71.5	44.6	5600	7100
60	95	18	1.1	30.7	22.7	6400	8100
	110	22	1.5	53.1	33.8	5400	6800
	130	31	1.5	81.8	51.8	3700	
	130	31	2.1	82.5	50.4	4800	5800
	130	31	2.1	81.8	51.8	4800	5800
150	35	2.1	109.8	70.3	4600	5400	
65	85	10	0.6	11.9	11.5	7100	8500
	120	23	1.5	56.2	41.3	5100	6100
	120	23	1.5	60.2	64	5100	6100
	140	33	2.1	92.8	59.7	4600	5400
	140	33	4	92.7	59.7	4600	5400
	160	37	2.1	119	78	4400	5100
	100	18	1.1	32.1	24.9	6000	7600
	100	11	0.6	20.5	18.6	6000	7600
100	18	1.1	32.1	24.9	6000	7600	
70	125	24	1.5	60.8	46.5	4800	5800
	150	35	2.1	105	69	4400	5100
	180	42	3	143	103	3700	4400
	110	20	1.1	38.6	30.6	5500	6900
75	115	20	1.1	37.7	33.1	5200	6500
	115	13	0.6	37.7	33.1	5200	6500
	130	25	1.5	66.5	50.5	4600	5400
	160	37	2.1	114	117	4200	4800
	190	45	3	153	114	3500	4200
80	125	22	1.1	47.5	39.8	4770	6000
	140	26	2	72.7	55	4400	5100
	170	39	2.1	120	87	3700	4400
	200	48	3	164	126	3300	3900
85	130	22	1.1	50.3	41.2	4800	5600

Bearing Designations		Mounting Dimensions			Mass
Present	Original	d _{amin}	D _{amax}	r _{amax}	
		mm			kg
6311E	311E	64	111	2	1.34
6311EK		64	111	2	1.32
6311EQ1		64	111	2	1.68
6411E	411E	66	129	2	2.34
63/56		66	110	2	1.31
6012E	112E	66.5	88.5	1	0.385
6212E	212E	68	102	1.5	0.791
6312E-2ZTN1/P64Z2YA		72	118	1.5	1.57
6312E	312E	71	119	2	1.7
6312EQ1		71	119	2	2.08
6412E	412E	71	139	2	2.8
61813/P4		68.2	81.8	0.6	0.129
6213E	213E	73	112	1.5	0.989
213J	370213	73	112	1.5	1.09
6313	313	76	129	2	2.08
6313K		76	129	2	2.08
6413E	413E	76	149	2	3.35
6013E	113E	71.5	93.5	1	0.411
16013E	700113E	69	96	0.6	0.292
		71.5	93.5	1	0.454
6214E	214E	78	117	1.5	1.08
6314E	314E	81	139	2	2.55
6414E	414E	83	167	2.5	4.64
6014E	114E	76.5	103.5	1	0.577
6015 E	115	81.5	108.5	1	0.604
16015E	700115E	79	111	0.6	0.453
6215E	215	83	122	1.5	1.22
6315	315	86	149	2	3.01
6415E	415E	88	177	2.5	5.69
6016E	116E	86.5	118.5	1	0.816
6216	216	89	131	2	1.4
6316E	316E	91	159	2	3.67
6416E	416E	93	187	2.5	7
6017E		91.5	123.5	1	0.841

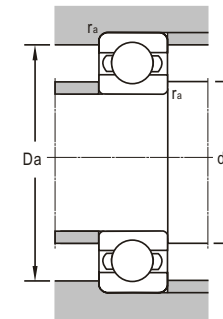
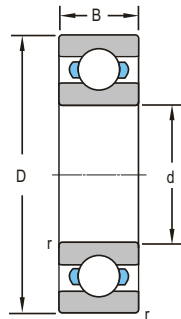

d 85~127mm

d	Boundary Dimensions			Basic Load Ratings		Limiting Speeds	
	D	B	r _{min}	Dynamic C	Static C ₀	Grease	Oil
mm				kN		r/min	
85	150	28	2	83.2	64	4200	4800
	180	41	3	133	96.5	3500	4200
	180	41	3	133	96.5	3500	4200
	210	52	4	169	137	3100	3700
90	140	24	1.5	58.5	50	4600	5600
	160	30	2	96	72	3700	4400
	190	43	3	144	109	3300	3900
	190	43	6	144	109	3300	3900
	225	54	4	194	159	2900	3500
95	145	16	1	43.9	42	4200	5000
	145	16	1	43.9	42	4200	5000
	145	24	1.5	78.5	50.1	4200	4800
	170	32	2.1	109	79.1	3500	4200
	200	45	3	152	121	3100	3700
100	150	24	1.5	63.5	55.4	4000	4800
	180	34	2.1	123	94	3200	3800
	215	47	3	137	141	2800	3400
	250	58	4	223	195	2600	3200
105	190	36	2.1	133	104	3000	3600
	180	32	2	102	81.7	3100	3600
	225	49	3	240	153	2700	3200
110	170	28	2	81.9	72.9	3400	4200
	150	20	1.1	60	60	3800	4500
	200	38	2.1	136	112	2800	3400
	240	50	3	208	177	2500	3000
120	150	16	1	30	33.8	3500	4400
	165	22	1.1	52.9	53.9	3300	4200
	180	28	2	88.1	79.7	3100	4000
	180	19	1	61	65	3200	4000
	180	19	1	61	65	3200	4000
	215	40	2.1	157	132	2700	3200
	260	55	3	228	207	2300	2800
127	177.8	25.4	2	39	55.2	3200	4000

Bearing Designations		Mounting Dimensions			Mass
Present	Original	d _{amin}	D _{amax}	r _{amax}	
		mm			kg
6217E	217E	94	141	2	1.93
6317E		98	167	2.5	4.21
6317EM	317EH	98	167	2.5	5.33
6417E	417E	101	194	3	7.91
6018E		98	132	1.5	1.12
6218E	218E	99	151	2	2.13
6318E	318E	103	177	2.5	4.93
6318E/YA2		103	177	2.5	4.9
6418E	418E	106	209	3	10.1
16019	700119E	100	140	1	0.816
16019/YB3		100	140	1	0.816
6019E		103	137	1.5	1.16
6219E	219E	106	159	2	2.62
6319E	319E	108	187	2.5	5.66
6020E		108	142	1.5	1.2
6220E	220E	111	169	2	3.23
6320E	320E	113	202	2.5	7.11
6420	420	118	232	3	12.8
6221E	221E	116	179	2	3.89
61121X3M/YB2		115	170	2	3.43
6321E	321E	118	212	2.5	8.03
6022E	122E	119	161	2	1.89
61922M		116.5	143.5	1	1.02
6222E	222E	121	189	2	4.45
6322E	322E	123	227	2.5	9.67
61924M	1000924H	126	144	1	0.559
6024E	124E	126.5	158.5	1	1.62
16024		129	171	2	1.99
16024		125	175	1	1.6
16024/YB2		125	175	1	1.6
6224E	224E	131	204	2	5.2
6324	324	133	247	2.5	12.2
66/127M/P5	D3-010	137	167.8	2	2.38

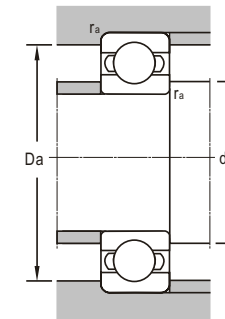
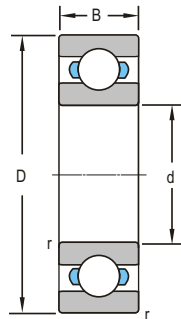

d 130--200mm

Boundary Dimensions				Basic Load Ratings		Limiting Speeds	
<i>d</i>	<i>D</i>	<i>B</i>	<i>r_{min}</i>	Dynamic <i>C</i>	Static <i>C₀</i>	Grease	Oil
mm				kN		r/min	
130	200	33	2	102	93.9	3000	3600
	230	40	3	166	148	2500	3000
	280	58	4	250	240	2100	2700
	280	58	4	250	240	2100	2700
	340	78	5	294	285	1400	1800
140	175	18	1.1	43.4	49.7	3000	3800
	175	18	1.1	43.4	49.7	3000	3800
	210	33	2	116	109	2800	3600
	250	42	3	167	151	2300	2800
	300	62	4	254	246	1900	2500
145	203	26	1.5	41.7	62.7	2850	3550
150	190	20	1.1	42.6	49.4	2900	3700
	210	28	2	85	89	2500	3200
	225	35	2.1	132	125	2400	3000
	270	45	3	190	183	1900	2500
	320	65	4	278	280	1800	2300
160	240	25	1.5	102	113	2100	2600
	290	48	3	215	218	1800	2300
	340	68	4	312	325	1700	2100
170	215	22	1.1	65	75.7	2500	3100
	260	42	2.1	161	160	2100	2700
	310	52	4	210	213	1900	2400
	360	72	4	303	330	1700	2000
180	250	33	2	128	137	2100	2600
	259.5	52	2	140	147	2200	2700
	280	46	2.1	196	203	2000	2600
	320	52	4	257	280	1800	2200
	380	75	4	340	393	1600	2000
190	259.5	33	2	117	133	1950	2500
200	250	24	1.5	73.8	98.9	2200	2800
	280	38	2.1	164	161	2000	2600
	310	51	2.1	223	246	1900	2400
	360	58	4	289	336	1700	2000

Bearing Designations		Mounting Dimensions			Mass
Present	Original	<i>d_{amin}</i>	<i>D_{amax}</i>	<i>r_{amax}</i>	
		mm			kg
6026		139	191	2	3.15
6226	226	143	217	2.5	6.19
6326M	326H	146	264	3	16.5
6326	326	146	264	3	12.7
6426M	426H	152	318	4	40.9
61828		146.5	168.5	1	0.8
61828/YB3		146.5	168.5	1	0.8
6028E		149	201	2	3.19
6228E	228E	153	237	2.5	7.77
6328M	328H	156	284	3	22.7
6629M/YA1	790829H	154	194	1.5	3.52
61830M/P6		156	184	1	1.43
61930M		159	201	2	3.01
6030EM	130E	161	214	2	4.88
6230	230	163	257	2.5	10.4
6330E	330E	166	304	3	21.7
16032E	700132E	168	252	1.5	3.54
6232E	232E	173	277	2.5	12.2
6332E	332E	176	324	3	26.3
61834	1000834	176.5	208.5	1	1.63
6034M	134	181	249	2	8.09
6234E	234E	186	294	3	15.2
6334E	334E	186	344	3	31.1
61936M	1000936H	189	241	2	5.04
63936X1M		189	250.5	2	8.79
6036	136	191	269	2	8.55
6236M	236H	196	304	3	19.4
6336E	336E	196	364	3	42.5
61938X1M		198	251.5	2	5.4
61840M	1000840H	208	242	1.5	2.691
61940M	1000940H	211	269	2	7.3
6040	140	211	299	2	11.7
6240E	240E	216	344	3	22.5

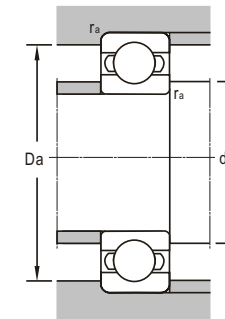
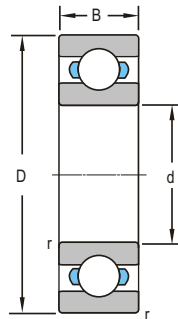

d 200--393. 7mm

Boundary Dimensions				Basic Load Ratings		Limiting Speeds	
<i>d</i>	<i>D</i>	<i>B</i>	<i>r_{min}</i>	Dynamic <i>C</i>	Static <i>C₀</i>	Grease	Oil
mm				kN		r/min	
200	420	80	5	370	460	1500	1800
220	300	38	2.1	152	175	1900	2300
	300	38	2.1	176	175	1900	2400
	340	56	3	251	292	1800	2000
	400	65	4	298	365	1500	1800
	460	88	5	407	522	1300	1600
240	320	38	2.1	154	194	1800	2200
	320	38	2.1	154	194	1800	2200
	360	56	3	256	316	1700	2000
	440	72	4	362	472	1300	1600
260	360	46	2.1	212	269	1600	1900
	400	44	3	231	301	1500	1800
280	380	46	2.1	216	283	1500	1800
	390	46	2.1	216	310	1450	1750
	405	56	2.1	260	346	1450	1750
300	380	38	2.1	167	238	1300	1600
	420	50	3	233	371	1300	1600
	420	56	3	268	372	1300	1600
	460	74	4	356	500	1200	1500
320	400	38	2.1	169	237	1300	1600
	440	37	2.1	279	396	1300	1600
	440	56	3	280	394	1200	1500
	480	74	4	360	524	1100	1400
	480	74	4	360	524	1100	1400
340	460	56	3	283	421	1000	1300
	520	82	5	410	621	1000	1300
	520	82	5	386	576	1000	1300
360	540	82	5	449	713	1000	1300
380	480	46	2.1	280	378	1000	1300
	520	44	3	247	380	950	1100
393.7	520.7	63.5	4	318	500	950	1200

Bearing Designations		Mounting Dimensions			Mass
Present	Original	<i>d_{amin}</i>	<i>D_amax</i>	<i>r_amax</i>	
		mm			kg
6340M	340H	220	400	4	59.2
61944E	1000944E	231	289	2	8.35
		231	289	2	7.6
		233	327	2.5	19.4
		236	384	3	36.5
		240	440	4	74.6
61948M/YA	1000948H	251	309	2	9.37
		251	309	2	9.6
		253	347	2.5	20.4
		256	424	3	53.9
61952M	1000952H	271	349	2	15.86
		273	387	2.5	22.5
61956M	1000956H	291	369	2	15
		301	369	2	17.3
		293	392	2	25.1
61860M	1000860H	311	369	2	11.1
		311	389	2.5	24.8
		313	407	2.5	24.5
		318	442	3	45.3
		331	389	2	11.8
61964	1000964	331	389	2	16.8
		333	427	2.5	27
		336	464	3	48.4
		336	464	3	48.4
		336	464	3	48.4
61968	1000968	353	447	2.5	27
		360	500	4	67.2
		360	500	4	67.8
6072	172	380	520	4	71.6
61876	1000876	391	469	2	20.5
		391	509	2.5	31.2
66/393.7		405	509	3.5	38.4

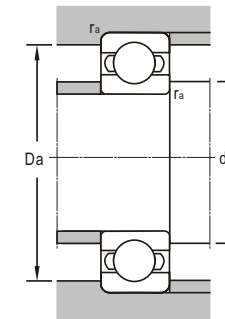
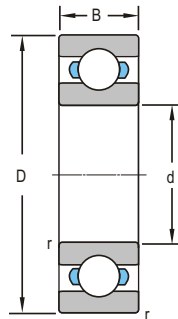

d 400--630mm

Boundary Dimensions				Basic Load Ratings		Limiting Speeds	
<i>d</i>	<i>D</i>	<i>B</i>	<i>r_{min}</i>	Dynamic <i>C</i>	Static <i>C₀</i>	Grease	Oil
mm				kN		r/min	
400	500	46	3.5	235	385	950	1200
	540	65	4	355	585	950	1100
	600	90	6	505	852	900	1100
	600	90	5	505	852	900	1100
406.4	546.1	69.85	4	353	576	950	1200
418.5	599	75	4	553	720	900	1100
420	520	46	2.1	245	378	920	1150
440	540	46	3.5	247	427	900	1100
	650	94	6	536	936	850	1000
460	580	56	3	310	561	900	1100
	620	74	5	410	728	850	1000
	680	100	6	605	1080	800	950
480	600	56	3	317	570	850	1000
	700	100	6	611	1120	750	900
500	620	56	3	327	611	800	950
	670	78	5	457	852	750	900
	720	100	6	630	1170	750	900
530	650	56	3	317	643	750	900
	710	82	5	475	912	700	850
	780	112	6	680	1300	670	800
	760	100	6	602	1180	680	830
540	800	115	6	643	1270	660	810
560	680	56	3	334	680	700	850
	750	85	5	525	1040	670	800
600	730	60	3	357	759	670	800
	800	90	5	579	1180	650	750
	819	90	5	612	1260	700	830
	870	118	6	715	1450	670	700
630	780	69	4	415	819	630	750

Bearing Designations		Mounting Dimensions			Mass
Present	Original	<i>d_{min}</i>	<i>D_{max}</i>	<i>r_amax</i>	
		mm			kg
61880	1000880	411	489	2	21.7
61980		416	524	3	42.6
6080	180	420	580	4	107
6080B		420	580	4	91
66/406.4		422	530	3.5	48.3
66/418.5/C9YA3		434.5	583	3.5	72.1
61884		431	509	2	22.6
61888	1000888	451	529	2	23.6
6088	188	466	624	5	107
61892	1000892	473	567	2.5	33.5
61992	1000992	476	604	3	65.6
6092	192	486	654	5	130
61896E	1000896E	493	587	2.5	36.5
6096	196	506	674	5	138
618/500	10008/500	513	607	2.5	36.1
619/500	10009/500	520	650	4	79.5
60/500	1/500	526	694	5	140
618/530	10008/530	543	637	2.5	40
619/530	10009/530	550	690	4	91.8
60/530	1/530	556	754	5	186
66/530		556	734	5	156
66/540		566	774	5	216
618/560E	10008/560E	573	667	2.5	45
619/560	10009/560	580	730	4	111
618/600	10008/600	613	717	2.5	53.1
619/600X1/P63		620	780	4	129
		618	801	4	149
	60/600MAS	613	857	5	242
618/630MA		648	762	3	76.3

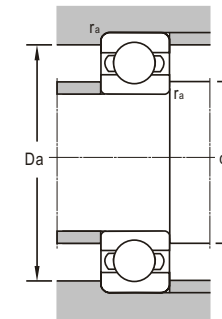
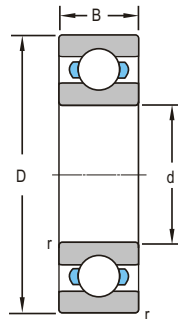

d 630--1250mm

Boundary Dimensions				Basic Load Ratings		Limiting Speeds	
<i>d</i>	<i>D</i>	<i>B</i>	<i>r_{min}</i>	Dynamic <i>C</i>	Static <i>C₀</i>	Grease	Oil
mm				kN		r/min	
630	780	69	4	415	819	630	750
	850	100	6	635	1320	600	700
	920	128	7.5	819	1760	560	670
670	820	69	4	420	980	560	670
	820	69	4	359	707	560	670
	980	136	7.5	894	2000	500	600
710	870	74	4	480	1010	600	520
	1030	140	7.5	956	2200	480	560
750	810	50	2.1	125	238	490	580
	812	50	2.1	125	238	490	580
	920	78	5	495	1080	520	600
	920	78	5	495	1080	520	600
780	1080	105	9.5	1230	3600	365	435
800	980	82	5	550	1360	450	530
	1060	115	6	827	1990	450	530
	1150	155	7.5	1470	2230	450	530
840	1030	85	5	578	1340	450	520
850	1150	110	10	1270	3860	430	500
900	1090	85	5	607	1580	380	450
	1090	85	5	594	1430	380	450
	1180	122	6	855	2160	340	400
	1280	170	7.5	1150	3060	320	380
1000	1220	100	6	636	1780	340	400
1060	1500	195	9.5	1310	3770	300	360
	1500	195	9.5	1310	3770	300	360
1180	1420	106	6	1170	3230	260	320
1250	1750	218	9.5	1630	5290	200	250
	1750	218	9.5	1630	5290	250	305

Bearing Designations		Mounting Dimensions			Mass
Present	Original	<i>d_{amin}</i>	<i>D_{amax}</i>	<i>r_amax</i>	
		mm			kg
618/630F1		648	762	3	75
619/630	19/630	656	824	5	165
60/630	1/630K	663	887	6	294
618/670	10008/670	686	804	3	81.9
618/670MA/C9		685	805	3	81.9
60/670NIMAS		703	947	6	348
618/710MA/C9		725	855	3	95
60/710	1/710K	743	997	6	396
66/750TN1/C9					24.6
66/750TN	1YA1/C9	762	800	2	25.5
618/750		770	900	4	112
618/750/YA		770	900	4	111
618/780X3	3707/780	822	1036	8	312
618/800E	10008/800E	820	960	4	133
619/800MA/C9		823	1037	5	294
60/800	1/800	836	1114	6	548
618/840		860	1010	4	153
618/850 X3	3707/850	904	1096	10	429
618/900	10008/900	920	1070	4	164
618/900MA/C9		918	1072	4	164
618/900MA/C9		920	1160	5	368
60/900 MA		923	1257	6	750
618/1000	10008/1000	1026	1194	5	266
60/1060M/C9		1098	1462	8	1212
60/1060M/C3 YA		1098	1462	8	1209
618/1180	18/1180	1208	1392	5	329
60/1250 M		1288	1712	8	1730
60/1250M/C3S0YA		1290	1710	8	1730

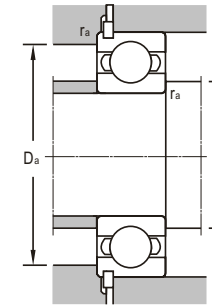
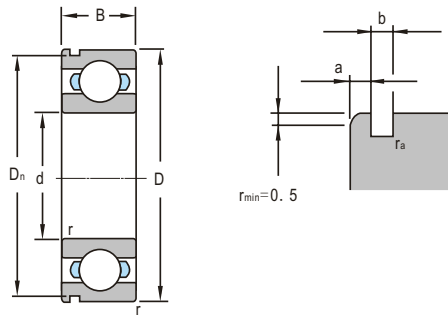

d 15~35mm

Boundary Dimensions								Basic Load Ratings		Limiting Speeds	
d	D	B	r _{min}	D _n	a	b	r _{1min}	Dynamic C	Static C ₀	Grease	Oil
mm								kN		r/min	
15	35	11	0.6	33.17	2.06	1.35	0.5	7.8	3.75	19000	24000
	42	13	1	39.75	2.06	1.35	0.5	11.4	5.42	17000	20000
17	40	12	0.6	38.1	2.06	1.35	0.4	9.56	4.75	17000	20000
	40	12	0.6	38.1	2.06	1.35	0.4	9.56	4.75	17000	20000
	47	14	1	44.6	2.46	1.35	0.4	13.5	6.5	16000	19000
	47	14	1	44.6	2.46	1.35	0.4	13.5	6.5	16000	19000
20	47	14	1	44.6	2.46	1.35	0.4	12.7	6.55	15000	18000
	47	14	1	44.6	2.46	1.35	0.4	12.7	6.55	15000	18000
	52	15	1.1	49.73	2.46	1.35	0.4	15.9	7.8	13000	16000
	52	15	1.1	49.73	2.46	1.35	0.4	15.9	7.8	13000	16000
22	56	16	1.1	53.6	2.46	1.35	0.5	30.9	15.2	10000	13000
	56	16	1.1	53.6	2.46	1.35	0.5	30.9	15.2	10000	13000
25	52	15	1	49.73	2.46	1.35	0.4	14.5	8.2	12000	15000
	52	15	1	49.73	2.46	1.35	0.4	14.5	8.2	12000	15000
	62	17	1.1	59.61	3.28	1.9	0.6	22.5	11.6	11000	14000
	62	17	1.1	59.61	3.28	1.9	0.6	22.5	11.6	11000	14000
28	52	12	0.6	49.73	2.06	1.35	0.5	12.4	7.37	12000	15000
	52	12	0.6	49.73	2.06	1.35	0.5	12.4	7.37	12000	15000
	68	18	1.1	64.82	3.28	1.9	0.5	26.8	14	1100	14000
	68	18	1.1	64.82	3.28	1.9	0.5	26.8	14	1100	14000
30	62	16	1	59.61	3.28	1.9	0.6	19.6	11.2	10000	13000
	62	16	1	59.61	3.28	1.9	0.6	19.6	11.2	10000	13000
	72	19	1.1	68.81	3.28	1.9	0.6	28.1	16	9000	11000
	72	19	1.1	68.81	3.28	1.9	0.6	28.1	16	9000	11000
	80	23	0.5				0.5	39.5	21.5	9000	
	90	23	1.5	86.79	3.28		0.6	44.6	23		
32	75	20	1.1	71.83	3.28	1.9	0.5	29.8	16.8	5000	11000
	75	20	1.1	71.83	3.28	1.9	0.5	29.8	16.8	5000	11000
35	72	17	1.1	68.81	3.28	1.9	0.6	25.5	15.3	9000	11000
	72	17	1.1	68.81	3.28	1.9	0.6	25.5	15.3	9000	11000
	80	21	1.5	76.81	3.28	1.9	0.6	35.8	19	8500	10000
	80	21	1.5	76.81	3.28	1.9	0.6	35.8	19	8500	10000
	100	25	1.5	96.8	3.28	2.7	0.6	55.8	31	7000	8500
	100	25	1.5	96.8	3.28	2.7	0.6	55.8	31	7000	8500

Bearing Designations		Mounting Dimensions			Mass
Present	Original	d _{amin}	D _{amax}	r _{amax}	
		mm			kg
6202EN	6302EN	19	31	0.6	0.0417
		21	37	1	0.0796
6203 EN	50203 E	21	36	0.6	0.0651
6203 E-ZN	150203 E	21	36	0.6	0.0651
6303 EN	50303 E	22	42	1	0.109
6303 E-ZN	150303 E	22	42	1	0.109
6204 EN	50204 E	25	42	1	0.103
6204 E-ZN	150204 E	25	42	1	0.103
6304 EN	50304 E	26.5	45.5	1	0.142
6304 E-ZN	150304 E	26.5	45.5	1	0.14
6404EN		26.5	65.5	1	0.405
63/22 E-NR		29	49	1	0.182
6205 EN	50205 E	30	47	1	0.127
6205 E-ZN	150204E	30	47	1	0.127
6305 EN	50305 E	31.5	55.5	1	0.217
6305 E-ZN	150305E	31.5	55.5	1	0.217
60/28EN		33	47	0.5	0.0971
60/28E-RSN		33	47	0.5	0.0971
63/28EN		35	61	1	0.278
63/28E-RSN		35	61	1	0.278
6206 EN	50206 E	35	57	1	0.197
6206 E-ZN	150206E	35	57	1	0.195
6306 EN	50306 E	36.5	65.5	1	0.349
6306 E-ZN	150304E	36.5	65.5	1	0.349
63/30EN/S0		38	72	0.5	0.518
6406EN					0.715
63/32 EN		39	68	1	0.397
6207 EN	50207 E	41.5	65.5	1	0.279
6207 E-ZN	150207E	41.5	65.5	1	0.279
6307 EN	50307 E	43	72	1.5	0.456
6307 E-ZN	150307E	43	72	1.5	0.42
6407 EN	50407 E	43	92	1.5	0.922
6407 E-ZN	150407E	43	92	1.5	0.917

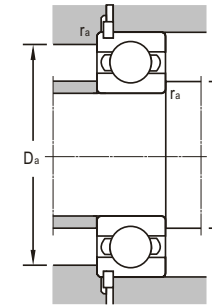
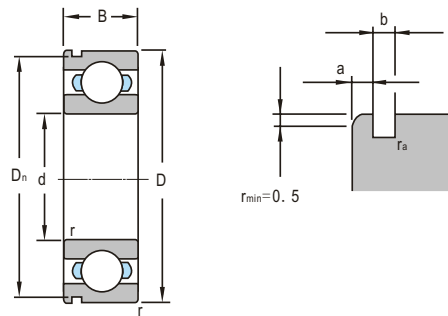

d 40~65mm

d	Boundary Dimensions							Basic Load Ratings		Limiting Speeds	
	D	B	r _{min}	D _n	a	b	r _{1smin}	Dynamic C	Static C ₀	Grease	Oil
mm											
kN											
r/min											
40	80	18	1.1	76.81	3.28	1.9	0.6	30.1	18.6	8500	10000
	80	18	1.1	76.81	3.28	1.9	0.6	30.1	18.6	8500	10000
	80	18	1.1					32.6	19.8		
	90	23	1.5	86.79	3.28	2.7	0.6	41.2	23.3	7300	8700
	90	23	1.5	86.79	3.28	2.7	0.6	41.2	23.3	7300	8700
	110	27	2	106.81	3.28	2.7	0.6	68	36.2	6500	8000
110	27	2	106.81	3.28	2.7	0.6	68	36.2	6500	8000	
45	85	19	1.1	81.81	3.28	1.9	0.6	32.2	21	7500	9000
	85	19	1.1	81.81	3.28	1.9	0.6	32.2	21	7500	9000
	100	25	1.5	96.8	3.28	2.7	0.6	53	30.5	6500	7800
	100	25	1.5	96.8	3.28	2.7	0.6	53	30.5	6500	7800
	120	29	2	115.21	4.06	3.1	0.6	79	44.1	5800	7000
	120	29	2	115.21	4.06	3.1	0.6	79	44.1	5800	7000
50	90	20	1.1	86.79	3.28	2.7	0.6	35.4	22.7	7000	8500
	90	20	1.1	86.79	3.28	2.7	0.6	35.4	22.7	7000	8500
	110	27	2	106.81	3.28	2.7	0.6	61.8	37.9	6300	7500
	110	27	2	106.81	3.28	2.7	0.6	61.8	37.9	6300	7500
	130	31	2.1	125.22	4.06	3.1	0.6	92	55	5300	6300
	130	31	2.1	125.22	4.06	3.1	0.6	92	55	5300	6300
55	100	21	1.5	96.8	3.28	2.7	0.6	43.3	28.1	6300	7500
	100	21	1.5	96.8	3.28	2.7	0.6	43.3	28.1	6300	7500
	120	29	2	115.21	4.06	3.1	0.6	71.5	44.6	5600	6700
	120	29	2	115.21	4.06	3.1	0.6	71.5	44.6	5600	6700
	140	33	2.1	135.23	4.9	3.1	0.6	101	62.4	5000	6000
	140	33	2.1	135.23	4.9	3.1	0.6	101	62.4	5000	6000
60	110	22	1.5	106.81	3.28	2.7	0.6	54	33	6000	7000
	110	22	1.5	106.81	3.28	2.7	0.6	54	33	6000	7000
	130	31	2.1	125.22	4.06	3.1	0.6	83	50.4	5000	6000
	130	31	2.1	125.22	4.06	3.1	0.6	83	50.4	5000	6000
	150	35	2.1	145.24	4.9	3.1	0.6	109	71	4800	5600
	150	35	2.1	145.24	4.9	3.1	0.6	109	71	4800	5600
65	120	23	1.5	115.21	4.06	3.1	0.6	54.2	39.3	5300	6300
	120	23	1.5	115.21	4.06	3.1	0.6	54.2	39.3	5300	6300
	140	33	2.1	135.23	4.9	3.1	0.6	89.5	59.7	4800	5600
	140	33	2.1	135.23	4.9	3.1	0.6	89.5	59.7	4800	5600

Bearing Designations		Mounting Dimensions			Mass
Present	Original	d _{amin}	D _{amax}	r _{amax}	
mm					
kg					
6208 EN	50208 E	46.5	73.5	1	0.353
6208 E-ZN	150208E	46.5	73.5	1	0.346
6208ENR					0.369
6308 EN	50308 E	48	82	1.5	0.6
6308 E-ZN	150308E	48	82	1.5	0.63
6408 EN	50408 E	49	101	2	1.164
6408 E-ZN	150408E	49	101	2	1.21
6209 EN	50209 E	51.5	78.5	1	0.401
6209 E-ZN	150209E	51.5	78.5	1	0.401
6309 EN	50309 E	53	92	1.5	0.83
6309 E-ZN	150309E	53	92	1.5	0.83
6409 EN	50409 E	54	111	2	1.55
6409 E-ZN	150409E	54	111	2	1.55
6210 EN	50210 E	56.5	83.5	1	0.454
6210 E-ZN	150210E	56.5	83.5	1	0.47
6310 EN	50310 E	59	101	2	1.05
6310 E-ZN	150310E	59	101	2	1.08
6410 EN	50410 E	61	119	2	1.91
6410 E-ZN	150410E	61	119	2	1.91
6211 EN	50211 E	63	92	1.5	0.595
6211 E-ZN	150211E	63	92	1.5	0.58
6311 EN	50311 E	64	111	2	1.33
6311 E-ZN	150311E	64	111	2	1.35
6411 EN	50411 E	66	129	2	2.3
6411 E-ZN	150411E	66	129	2	2.3
6212 EN	50212 E	68	102	1.5	0.785
6212 E-ZN	150212E	68	102	1.5	0.781
6312 EN	50312 E	71	119	2	1.68
6312 E-ZN	150312E	71	119	2	1.71
6412 EN	50412 E	71	139	2	2.77
6412 E-ZN	150412E	71	139	2	2.77
6213 EN	50213 E	73	112	1.5	0.961
6213 E-ZN	150213E	73	112	1.5	0.96
6313 EN	50313 E	76	129	2	2.06
6313 E-ZN	150313E	76	129	2	2.09



Deep Groove Ball Bearings
with a snap ring groove

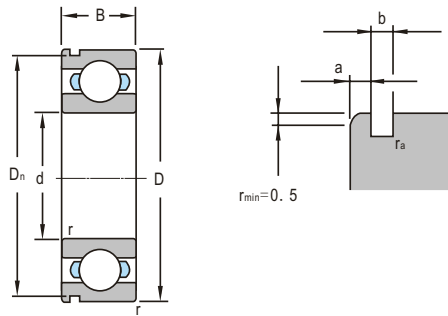

d 70~105mm

Boundary Dimensions								Basic Load Ratings		Limiting Speeds	
<i>d</i>	<i>D</i>	<i>B</i>	<i>r_{min}</i>	<i>D_n</i>	<i>a</i>	<i>b</i>	<i>r_{1smin}</i>	Dynamic <i>C</i>	Static <i>C₀</i>	Grease	Oil
mm								kN		r/min	
70	125	24	1.5	120.22	4.06	3.1	0.6	58.9	43.6	5000	6000
	125	24	1.5	120.22	4.06	3.1	0.6	58.9	43.6	5000	6000
	150	35	2.1	145.24	4.9	3.1	0.6	104	69	4500	5300
	150	35	2.1	145.24	4.9	3.1	0.6	104	69	4500	5300
	150	35	2.1	145.24	4.9	3.1	0.6	104	68	4500	5300
80	140	26	2	135.23	4.9	3.1	0.5	72.7	53	4500	5300
105	190	36	2.1	183.64	5.69	3.5	0.5	133	104	3200	3800

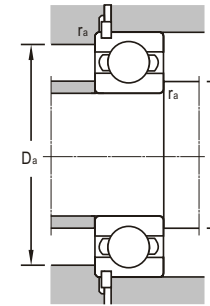

Bearing Designations		Mounting Dimensions			Mass
Present	Original	<i>d_{amin}</i>	<i>D_{amax}</i>	<i>r_{amax}</i>	
		mm			kg
6214 EN	50214 E	78	117	1.5	1.04
6214 E-ZN		78	117	1.5	1.04
6314 EN	50314 E	81	139	2	2.52
6314 E-ZN		81	139	2	2.55
6314EN/YA		81	139	2	2.52
6216N		89	131	2	1.38
6221EN		116	179	2	3.79

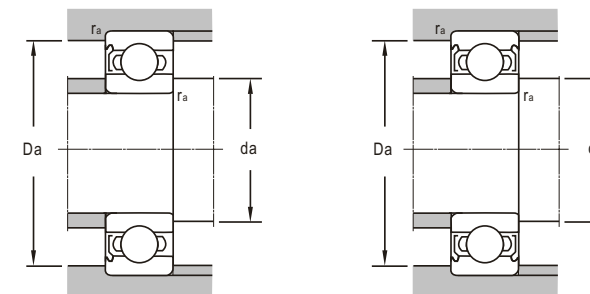
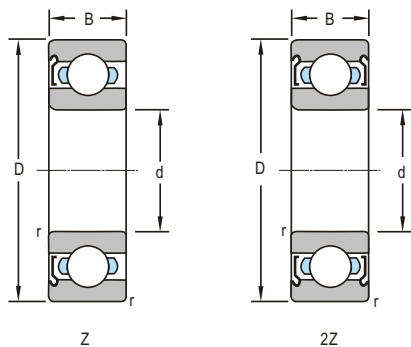

d 10~25mm

Boundary Dimensions				Basic Load Ratings		Limiting Speeds	
d	D	B	r _{min}	Dynamic C	Static C ₀	Grease	Oil
mm				kN		r/min	
10	30	9	0.6	6.6	3.2	24000	30000
	30	9	0.6	6.6	3.2	24000	30000
	35	11	0.6	8.06	3.4	20000	26000
	35	11	0.6	8.06	3.4	20000	26000
12	28	8	0.3	4.98	2.39	26000	32000
	28	8	0.3	4.98	2.39	26000	32000
	32	10	0.6	6.89	3.1	22000	28000
	32	10	0.6	6.89	3.1	22000	28000
	37	12	1	9.75	4.15	19000	24000
	37	12	1	9.75	4.15	19000	24000
15	28	7	0.3	4.31	1.94	24000	30000
	32	9	0.3	5.48	2.8	22000	28000
	32	9	0.3	5.48	2.8	22000	28000
	35	11	0.6	7.8	3.75	19000	24000
	35	11	0.6	7.8	3.75	19000	24000
	42	13	1	11.4	5.4	17000	20000
	42	13	1	11.4	5.4	17000	20000
17	35	10	0.3	5.93	3.18	19000	24000
	35	10	0.3	5.93	3.18	19000	24000
	40	12	0.6	9.56	4.75	17000	20000
	40	12	0.6	9.56	4.75	17000	20000
	47	14	1	13.5	6.5	15500	18000
	47	14	1	13.5	6.5	15500	18000
20	37	9	0.3	6.38	3.68	18000	22000
	37	9	0.3	6.38	3.68	18000	22000
	42	12	0.6	9.17	4.9	17000	20000
	42	12	0.6	9.17	4.9	17000	20000
	47	14	1	12.7	6.5	15000	18000
	47	14	1	12.7	6.5	15000	18000
	52	15	1.1	15.9	7.8	13000	16000
	52	15	1.1	15.9	7.8	13000	16000
	52	15	1.1	15.9	7.8	13000	16000
22	47	12	0.6	7.74	4.96	15500	18500
	47	12	0.6	11	6.42	15000	18000
25	37	7	0.3	4.27	2.63	16500	19500
	37	7	0.3	4.27	2.63	16500	19500

Bearing Designations		Mounting Dimensions			Mass
Present	Original	D _{amin}	D _{amax}	r _{amax}	
		mm			kg
6200E-Z	60200E	14	26	0.6	0.0304
6200E-2Z	80200E	14	26	0.6	0.0296
6300E-Z	60300E	14	31	0.6	0.051
6300E-2Z	80300E	14	31	0.6	0.0486
6001E-Z	60101E	14	26	0.3	0.02
6001E-2Z	80101E	14	26	0.3	0.0194
6201E-Z	60201E	16	28	0.6	0.0346
6201E-2Z	80201E	16	28	0.6	0.0339
6301E-Z	60301E	17	32	1	0.0572
6301E-2Z	80301E	17	32	1	0.0565
61902E-2Z		17	26	0.3	0.0139
6002E-Z	60102E	17	30	0.3	0.0297
6002E-2Z	80102E	17	30	0.3	0.0289
6202E-Z	60202E	19	31	0.6	0.0412
6202E-2Z	80202E	19	31	0.6	0.0395
6302E-Z	60302E	20	37	1	0.0803
6302E-2Z	80302E	20	37	1	0.0802
6003E-Z	60103E	19	33	0.3	0.0374
6003E-2Z	80103E	19	33	0.3	0.0366
6203E-Z	60203E	21	36	0.6	0.0657
6203E-2Z	80203E	21	36	0.6	0.0647
6303E-Z	60303	22	42	1	0.109
6303E-2Z	80303	22	42	1	0.108
61904E-Z		22.4	34.8	0.3	0.036
61904E-2Z		22.4	34.8	0.3	0.0359
6004E-Z	60104E	24	38	0.6	0.0677
6004E-2Z	80104E	24	38	0.6	0.0667
6204E-Z	60204E	25	42	1	0.104
6204E-2Z	80204E	25	42	1	0.103
6304E-Z	60304E	26.5	45.5	1	0.142
6304E-2Z	80304E	26.5	45.5	1	0.14
62/22 EX1-Z		26	43	0.6	0.0441
60/22 EX1-Z					0.0857
61805-Z		27	35	0.3	0.0222
61805-2Z		27	35	0.3	0.0222

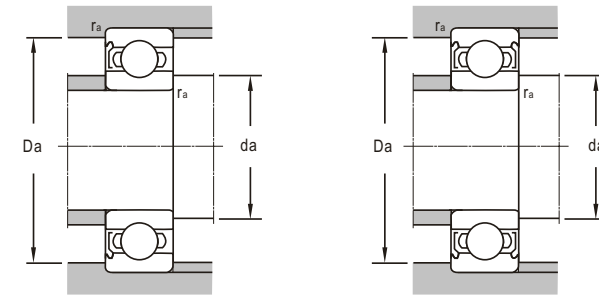
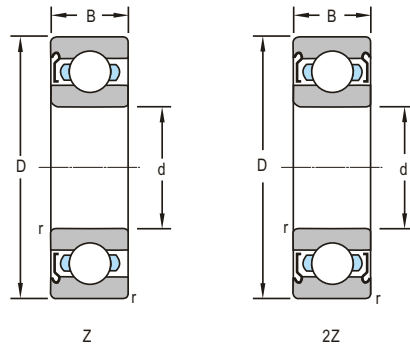

d 25~45mm

Boundary Dimensions				Basic Load Ratings		Limiting Speeds	
d	D	B	r _{min}	Dynamic C	Static C ₀	Grease	Oil
mm				kN		r/min	
25	47	12	0.6	11	6.42	15000	18000
	47	12	0.6	11	6.42	15000	18000
	47	12	1	11	6.42	15000	18000
	52	15	1	14.5	8.3	12000	15000
	52	15	1	14.5	8.3	12000	15000
	62	17	1.1	22.5	11.6	11000	14000
62	17	1.1	22.5	11.6	11000	14000	
30	42	7	0.3	4.4	3	15000	18000
	42	7	0.3	4.4	3	15000	18000
	55	13	1	13.5	8.15	12000	15000
	55	13	1	13.5	8.15	12000	15000
	62	16	1	19.5	11.2	10000	13000
	62	16	1	19.5	11.2	10000	13000
	62	16	1	19.5	11.2	10000	13000
	72	19	1.1	28.1	16	9000	11000
	72	19	1.1	28.1	16	9000	11000
	35	62	14	1	16	10.3	10000
62		14	1	16	10.3	10000	13000
72		17	1.1	25.5	15.3	9000	11000
72		17	1.1	25.5	15.3	9000	11000
80		21	1.5	35.7	19.5	8500	10000
80		21	1.5	35.7	19.5	8500	10000
40	62	12	0.6	13.5	9.75	10000	13000
	62	12	0.6	13.5	9.75	10000	13000
	68	15	1	16.8	11.7	9200	11600
	68	15	1	16.8	11.7	9200	11600
	80	18	1.1	32	18.6	8200	9700
	80	18	1.1	32	18.6	8200	9700
	90	23	1.5	40.8	24	5500	
	90	23	1.5	40.8	24	5500	
	90	23	1.5	41.5	24.3	7300	8700
	90	23	1.5	41.5	24.3	7300	8700
45	75	16	1	21	14.9	8300	10500
	75	16	1	21	14.9	8300	10500
	85	19	1.1	33.2	21	7500	8700
	85	19	1.1	33.2	21	7500	8700
	85	19	1.1	31.7	20.8	7500	8700

Bearing Designations		Mounting Dimensions			Mass
Present	Original	D _{amin}	D _{amax}	r _{amax}	
		mm			kg
6005 E-Z	60105E	29	43	0.6	0.0753
6005 E-2Z	60105E	29	43	0.6	0.0766
6005 WB1-Z	260105K	29	43	0.6	0.0809
6205 E-Z	60205E	30	47	1	0.129
6205 E-2Z	80205E	30	47	1	0.127
6305 E-Z	60305E	31.5	55.5	1	0.219
6305 E-2Z	80305E	31.5	55.5	1	0.219
61806-Z		32	40	0.3	0.0256
61806-2Z		32	40	0.3	0.0255
6006 E-Z	60106E	35	50	1	0.109
6006 E-2Z	80106E	35	50	1	0.111
6206 E-Z	60206E	35	57	1	0.198
6206 E-2Z	80206E	35	57	1	0.197
6206 E-2Z/HTB		35	57	1	0.196
6306 E-Z	60306E	36.5	65.5	1	0.348
6306 E-2Z	80306E	36.5	65.5	1	0.347
6007 E-Z	60107E	40	57	1	0.149
6007 E-2Z	80107E	40	57	1	0.15
6207 E-Z	60207E	41.5	65.5	1	0.283
6207 E-2Z	80207E	41.5	65.5	1	0.28
6307 E-Z	60307E	43	72	1.5	0.461
6307 E-2Z	80307E	43	72	1.5	0.465
61908-Z		43.2	58.8	0.6	0.12
61908-2Z		43.2	58.8	0.6	0.119
6008 E-Z	60108E	45	63	1	0.189
6008 E-2Z	80108E	45	63	1	0.193
6208 E-Z	60208E	46.5	73.5	1	0.352
6208 E-2Z	80208E	46.5	73.5	1	0.345
6308 E-2ZTN1/P64Z2YA		49	81	1.5	0.591
6308 E-2ZP64Z2YA		49	81	1.5	0.612
6308 E-Z	60308E	48	82	1.5	0.606
6308 E-2Z	80308E	48	82	1.5	0.603
6009 E-Z	60109E	50	70	1	0.231
6009 E-2Z	80109E	50	70	1	0.236
6209 E-Z	60209E	51.5	78.5	1	0.402
6209 E-2Z	80209E	51.5	78.5	1	0.397
6209 E-2Z/YA		51.5	78.5	1	0.437

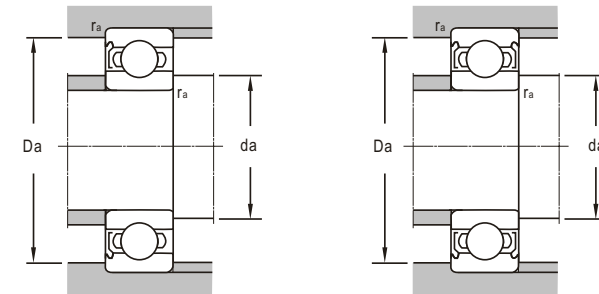
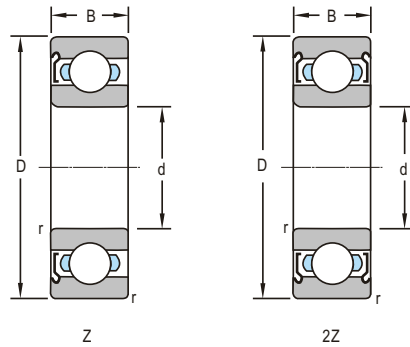

d 45~95mm

Boundary Dimensions				Basic Load Ratings		Limiting Speeds	
<i>d</i>	<i>D</i>	<i>B</i>	<i>r_{min}</i>	Dynamic <i>C</i>	Static <i>C₀</i>	Grease	Oil
mm				kN		r/min	
45	100	25	1.5	52.8	30.5	6500	7800
	100	25	1.5	52.8	30.5	6500	7800
50	80	16	1	21.8	16.6	8000	9700
	80	16	1	22	16.2	8000	9700
	80	16	1	22	16.2	8000	9700
	90	20	1.1	35.4	23.8	6800	8200
	90	20	1.1	35.4	23.8	6800	8200
	110	27	0.2	61.8	37.9	4300	6100
55	100	21	1.5	43.3	28.1	6100	7300
	100	21	1.5	43.3	28.1	6100	7300
	120	29	2	71.5	44.6	5400	6500
	120	29	2	71.5	44.6	5400	6500
60	110	22	1.5	53.3	33.5	5400	6800
	110	22	1.5	53.3	33.5	5400	6800
65	100	18	1.1	32.1	24.9	6000	7600
	100	18	1.1	32.1	24.9	6000	7600
	120	23	1.5	56.5	41.2	5100	6100
	120	23	1.5	56.5	41.2	5100	6100
70	125	24	1.5	60.8	46.5	4800	5800
	125	24	1.5	60.8	46.5	4800	5800
75	130	25	1.5	65	50.5	4600	5400
	130	25	1.5	64.3	47.5	4600	5400
80	140	26	2	72.7	53	4400	5100
	140	26	2	72.7	53	4400	5100
	170	39	1.5	123	86.5	2800	
85	130	22	1.1	50.3	41.2	4800	5600
	130	22	1.1	50.3	41.2	4800	5600
	150	28	2	83.2	64	4200	4800
	150	28	2	83.2	64	4200	4800
90	190	43	2	143	107	2400	
95	145	24	1.5	79	55	4200	4800
	145	24	1.5	79	55	4200	4800

Bearing Designations		Mounting Dimensions			Mass
Present	Original	<i>D_{amin}</i>	<i>D_{amax}</i>	<i>r_{amax}</i>	
		mm			kg
6309E-Z	60309E	53	92	1.5	0.815
6309E-2Z	80309E	53	92	1.5	0.814
6010E/YA/P53V2			75.4	1	0.264
6010E-Z	60110E	55	75	1	0.257
6010E-2Z	80110E	55	75	1	0.263
6210E-Z	60210E	56.5	83.5	1	0.47
6210E-2Z	80210E	56.5	83.5	1	0.476
6310 E-2ZTN1/P64Z2YUA		59	101	0.2	1.03
6310E-Z	60310E	59	101	2	1.06
6310E-2Z	80310E	59	101	2	1.05
6211E-Z	60211E	63	92	1.5	0.614
6211E-2Z	80211E	63	92	1.5	0.621
6311E-Z	60311E	64	111	2	1.35
6311E-2Z	80311E	64	111	2	1.37
6212E-Z	60212E	68	102	1.5	0.793
6212E-2Z	80212E	68	102	1.5	0.791
6013E-Z	60113E	71.5	93.5	1	0.406
6013E-2Z	80113E	71.5	93.5	1	0.414
6213E-Z	60213E	73	112	1.5	0.988
6213E-2Z	80213E	73	112	1.5	0.986
6214E-Z	60214E	78	117	1.5	1.1
6214E-2Z	80214E	78	117	1.5	1.1
6215E-Z	60215E	83	122	1.5	1.25
6215E-2Z	80215E	83	122	1.5	1.28
6216-Z	60216	89	131	2	1.46
6216-2Z	80216	89	131	2	1.47
6316 E-2ZP64Z2YA		92	158	1.5	3.66
6017E-Z	60117E	91.5	123.5	1	0.832
6017E-2Z	80117E	91.5	123.5	1	0.835
6217E-Z	60217E	94	141	2	1.87
6217E-2Z	80217E	94	141	2	1.95
6318 E-2Z/C4YA		104	176	2	4.99
6019E-Z	60119E	103	137	1.5	1.17
6019E-2Z	80119E	103	137	1.5	1.19

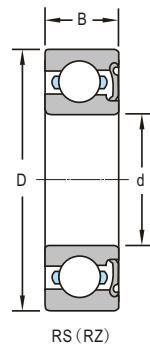

RS (RZ)

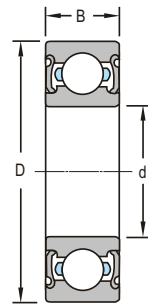

2RS (2RZ)

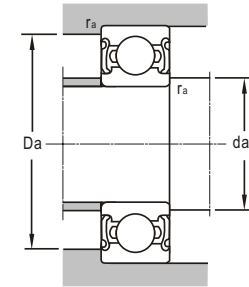
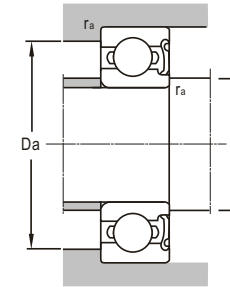

d 10~17mm

d	Boundary Dimensions			Basic Load Ratings		Limiting Speeds	
	D	B	r _{min}	Dynamic C	Static C ₀	Grease	Oil
mm				kN		r/min	
10	30	9	0.6	5.11	2.39	17000	
	30	9	0.6	5.11	2.39	17000	
	30	9	0.6	5.1	2.39	19000	
	30	9	0.6	5.1	2.39	19000	
	35	11	0.6	8.06	3.4	17000	
	35	11	0.6	8.06	3.4	17000	
37	14	0.6	5.11	2.39	14000		
12	28	8	0.3	4.98	2.39	17000	
	28	8	0.3	4.98	2.39	17000	
	28	8	0.3	4.98	2.39	19000	
	28	8	0.3	4.98	2.39	19000	
	32	10	0.6	6.89	3.1	15000	
	32	10	0.6	6.89	3.1	15000	
	32	10	0.6	6.89	3.1	17000	
	32	10	0.6	6.89	3.1	17000	
	37	12	1	9.75	4.15	17000	
	37	12	1	9.75	4.15	17000	
	37	12	1	9.75	4.15	14000	
	37	12	1	9.75	4.15	14000	
	42	18	1	9.71	4.19	13000	
	42	18	1	9.71	4.19	13000	
15	32	9	0.3	5.48	2.8	14000	
	32	9	0.3	5.48	2.8	14000	
	35	11	0.6	7.8	3.75	13000	
	35	11	0.6	7.8	3.75	13000	
	35	11	0.6	7.8	3.75	15000	
	35	11	0.6	7.8	3.75	15000	
	35	14	0.6	7.64	3.72	13000	
	42	13	1	11.4	5.4	14000	
	42	13	1	11.4	5.4	14000	
	42	13	1	11.4	5.4	12000	
	42	13	1	11.4	5.4	12000	
	17	35	10	0.3	5.93	3.18	15500
35		10	0.3	5.93	3.18	15500	
35		10	0.3	5.93	3.18	13000	
35		10	0.3	5.93	3.18	13000	
40		12	0.6	9.56	4.75	14500	
40		12	0.6	9.56	4.75	14500	

Bearing Designations		Mounting Dimensions			Mass
Present	Original	d _{amin}	D _{amax}	r _{amax}	
		mm			kg
6200-RS	160200	14	26	0.5	0.0296
6200-2RS	180200	14	26	0.5	0.0296
6200E-RZ	160200K	14	26	0.6	0.0295
6200E-2RZ	180200K	14	26	0.6	0.0295
6300 E-RZ		14	31	0.6	0.0508
6300 E-2RZ		14	31	0.6	0.0483
6400 EWBTN1-2RZ		14	33	0.6	0.0766
6001E-RS		14	26	0.3	0.021
6001E-2RS		14	26	0.3	0.02
6001 E-RZ	160101 EK	14	26	0.3	0.0217
6001 E-2RZ	180101 EK	14	26	0.3	0.0221
6201 E-RS	160201	16	28	0.6	0.0347
6201 E-2RS	180201	16	28	0.6	0.0356
6201 E-RZ	16020K	16	28	0.6	0.025
6201 E-2RZ	180201EK	16	28	0.6	0.034
6301E-RZ		17	32	1	0.0572
6301E-2RZ		17	32	1	0.0566
6301 E-RS		17	32	1	0.0573
6301 E-2RS		17	32	1	0.0566
62401X1S-RS		17	37	1	0.128
62401X1S-2RS		17	37	1	0.127
6002 E-RZ	160102EK	17	30	0.3	0.0292
6002 E-2RZ	180102EK	17	30	0.3	0.0292
6202E-RS	160202	19	31	0.6	0.0419
6202E-2RS	180202E	19	31	0.6	0.0393
6202E-RZ	160202K	19	31	0.6	0.0419
6202E-2RZ	180202EK	19	31	0.6	0.0392
6202 EX2-2RS/C3		20	37	1	0.0839
6302E-RZ		20	37	1	0.082
6302E-2RZ		20	37	1	0.0839
6302 E-RS	160302E	20	37	1	0.08
6302 E-2RS	180302E	20	37	1	0.08
6003 E-RZ	160103EK	19	33	0.3	0.0364
6003 E-2RZ	180103EK	19	33	0.3	0.0364
6003 E-RS		19	33	0.3	0.0668
6003 E-2RS		19	33	0.3	0.0382
6203 E-RZ/C9	60203EKU	21	36	0.6	0.0657
6203 E-2RZ/C9	80203EKU	21	36	0.6	0.0657



Deep Groove Ball Bearings
with seal

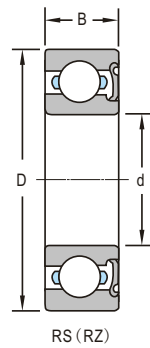

RS (RZ)

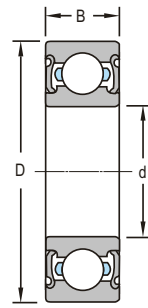

2RS (2RZ)

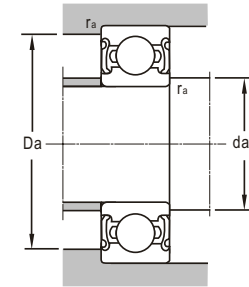
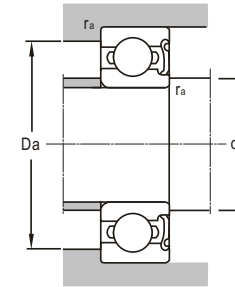

d 17~25mm

d	Boundary Dimensions			Basic Load Ratings		Limiting Speeds		
	D	B	r _{min}	Dynamic C	Static C ₀	Grease	Oil	
mm				kN		r/min		
17	40	12	0.6	9.56	4.75	12000		
	40	12	0.6	9.56	4.75	12000		
	40	12	0.6	9.5	4.75	14500		
	40	12	0.6	9.5	4.75	14500		
	47	14	1	13.5	6.5	11000		
	47	14	1	13.5	6.5	11000		
20	47	14	1	13.5	6.5	12500		
	47	14	1	13.5	6.5	12500		
	42	12	0.6	7.22	4.46	12500		
	42	12	0.6	7.22	4.46	12500		
	42	12	0.6	9.15	4.9	11000		
	42	12	0.6	9.15	4.9	11000		
	47	14	1	12.7	6.5	10000		
	47	14	1	12.7	6.5	10000		
	47	14	1	12.7	6.5	11500		
	47	14	1	12.7	6.5	11500		
	47	18	1	12.7	6.5	11500		
	47	18	1	12.7	6.5	11500		
52	15	15	1.1	15.9	7.8	11000		
	15	15	1.1	15.9	7.8	11000		
	15	15	1.1	15.9	7.8	9500		
	15	15	1.1	15.9	7.8	9500		
	22	50	14	1	13.7	7.5	10000	
		50	14	1	13.7	7.5	10000	
25	47	12	0.6	11	6.42	9500		
	47	12	0.6	11	6.42	9500		
	47	12	0.6	11	6.42	11000		
	47	12	0.6	11	6.42	11000		
	52	15	1	14.5	8.2	8500		
	52	15	1	14.5	8.2	8500		
	52	15	1	14.5	8.2	9500		
	52	15	1	14.5	8.2	9500		
	52	18	1	14.5	8.2	8500		
	52	18	1	14.5	8.2	8500		
	62	17	1.1	22.5	11.6	9000		
	62	17	1.1	22.5	11.6	9000		
	62	17	1.1	22.5	11.6	7500		
	62	17	1.1	22.5	11.6	7500		

Bearing Designations		Mounting Dimensions			Mass
Present	Original	d _{amin}	D _{a max}	r _{a max}	
		mm			kg
6203 E-RS	160203E	21	36	0.6	0.0668
6203 E-2RS	180203E	21	36	0.6	0.0667
6203 E-RZ	160203EK	21	36	0.6	0.0667
6203 E-2RZ	180203EK	21	36	0.6	0.0665
6303E-RS		22	42	1	0.114
6303E-2RS		22	42	1	0.113
6303E-RZ		22	42	1	0.114
6303E-2RZ		22	42	1	0.113
6004E-RZ		24	38	0.6	0.0693
6004E-2RZ		24	38	0.6	0.0673
6004E-RS		24	38	0.6	0.0693
6004E-2RS		24	38	0.6	0.0693
6204 E-RS	160204E	25	42	1	0.104
6204 E-2RS	180204E	25	42	1	0.103
6204 E-RZ	160204K	25	42	1	0.104
6204 E-2RZ	180204EK	25	42	1	0.102
62204 E-RZ		25	42	1	0.133
62204 E-2RZ		25	42	1	0.133
6304E-RZ		26.5	45.5	1	0.147
6304E-2RZ		26.5	45.5	1	0.147
6304 E-RS		26.5	45.5	1	0.147
6304 E-2RS		26.5	45.5	1	0.147
62/22E-RS		27	45	1	0.119
62/22E-2RS		27	45	1	0.119
6005 E-RS		29	43	0.6	0.08
6005 E-2RS		29	43	0.6	0.08
6005 E-RZ		29	43	0.6	0.0756
6005 E-2RZ		29	43	0.6	0.0774
6205 E-RS	160205E	30	47	1	0.128
6205 E-2RS	180205E	30	47	1	0.126
6205 E-RZ	160205EK	30	47	1	0.124
6205 E-2RZ	180205EK	30	47	1	0.126
62205E-RS		30	47	1	0.158
62205E-2RS		30	47	1	0.157
6305E-RZ		31.5	55.5	1	0.225
6305E-2RZ		31.5	55.5	1	0.218
6305 E-RS		31.5	55.5	1	0.225
6305 E-2RS		31.5	55.5	1	0.225



Deep Groove Ball Bearings
with seal

LYC®

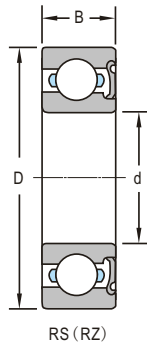

RS (RZ)

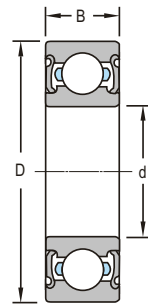

2RS (2RZ)

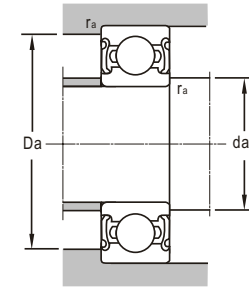
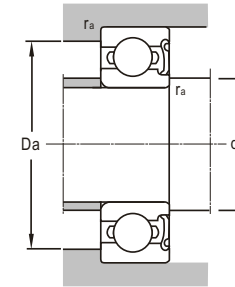

d 30~40mm

Boundary Dimensions				Basic Load Ratings		Limiting Speeds	
d	D	B	r _{min}	Dynamic C	Static C ₀	Grease	Oil
mm				kN		r/min	
30	55	13	1	13.5	8.5	9500	
	55	13	1	13.5	8.5	9500	
	55	13	1	13.5	8.5	8000	
	55	13	1	13.5	8.5	8000	
	62	16	1	19.5	11.2	9000	
	62	16	1	19.5	11.2	9000	
	62	16	1	19.5	11.2	7500	
	62	16	1	19.5	11.2	7500	
	62	20	1	19.5	11.2	7500	
	62	20	1	19.5	11.2	7500	
	66	17	0.6	23.5	13.1		
	72	19	1.1	28.1	16	7500	
72	19	1.1	28.1	16	7500		
72	19	1.1	28.1	16	6300		
72	19	1.1	28.1	16	6300		
72	19	1.1	28.2	15.8	7100		
80	23	0.4	39.5	21.5	6500		
32	75	20	1.1	29.8	16.8	6300	
	75	20	1.1	29.8	16.8	6300	
35	62	14	1	16	10.3	7000	
	62	14	1	16	10.3	7000	
	72	17	1.1	25.5	15.3	7500	
	72	17	1.1	25.5	15.3	7500	
	72	17	1.1	25.5	15.3	6300	
	72	17	1.1	25.5	15.3	6300	
	80	21	1.5	36	19.5	7200	
	80	21	1.5	36	19.5	7200	
40	68	15	1	16.5	11.5	6300	
	68	15	1	16.5	11.5	6300	
	80	18	1.1	31.3	18.6	6600	
	80	18	1.1	31.3	18.6	6600	
	80	18	1.1	31.3	18.6	5600	
	80	18	1.1	31.3	18.6	5600	
	90	23	1.5	42	24	5000	
	90	23	1.5	42	24	5000	
	90	23	1.5	31.4	22.4	5000	

Bearing Designations		Mounting Dimensions			Mass
Present	Original	d _{amin}	D _{amax}	r _{amax}	
		mm			kg
6006 E-RZ	160106EK	35	50	1	0.11
6006 E-2RZ	180106EK	35	50	1	0.11
6006 E-RS	160106E	35	50	1	0.114
6006 E-2RS	180106E	35	50	1	0.114
6206 E-RZ		35	57	1	0.21
6206 E-2RZ		35	57	1	0.2
6206 E-RS	160206E	35	57	1	0.02
6206 E-2RS	180206E	35	57	1	0.197
62206 E-RS		35	57	1	0.251
62206 E-2RS		35	57	1	0.254
6206 EX3-2RSN		35	57	1	0.258
6306 E-RZ	160306EK	36.5	65.5	1	0.348
6306 E-2RZ	180306EK	36.5	65.5	1	0.348
6306 E-RS		36.5	65.5	1	0.349
6306 E-2RS		36.5	65.5	1	0.347
6306 ETN1-2RZ/P6		37	65	1	0.338
TM6307/30YA9-2RS1/P6CS28ZZ		38	72	0.4	0.524
63/32-RS		39	68	1	0.408
63/32-2RS	63/32E-2RS	39	68	1	0.408
6007 E-RS		40	57	1	0.151
6007 E-2RS		40	57	1	0.154
6207 E-RZ		41.5	65.5	1	0.287
6207 E-2RZ		41.5	65.5	1	0.28
6207 E-RS	160207E	41.5	65.5	1	0.27
6207 E-2RS	180207E	41.5	65.5	1	0.28
6307 E-RZ		43	72	1.5	0.466
6307 E-2RZ		43	72	1.5	0.42
6307 E-RS		43	72	1.5	0.42
6307 E-2RS		43	72	1.5	0.466
6008 E-RS		45	63	1	0.188
6008 E-2RS		45	63	1	0.188
6208 E-RZ		46.5	73.5	1	0.364
6208 E-2RZ		46.5	73.5	1	0.356
6208 E-RS	160208E	46.5	73.5	1	0.364
6208 E-2RS	180208E	46.5	73.5	1	0.355
6308 E-RZ	160308EK	48	82	1.5	0.609
6308 E-2RZ	180308EK	48	82	1.5	0.608
6308 E-2RS		48	82	1.5	0.608



Deep Groove Ball Bearings
with seal

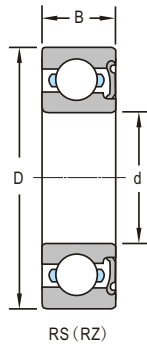

RS (RZ)

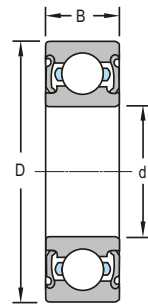

2RS (2RZ)

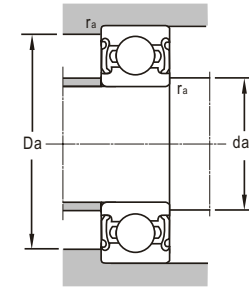
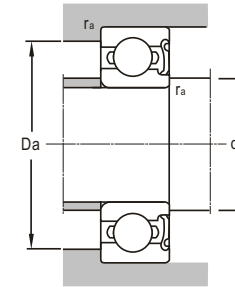

d 45~80mm

d	Boundary Dimensions			Basic Load Ratings		Limiting Speeds	
	D	B	r _{min}	Dynamic C	Static C ₀	Grease	Oil
mm							
45	75	16	1	21	14.9	5600	
	75	16	1	21	14.9		
	85	19	1.1	32.2	21		
	85	19	1.1	32.2	21		
	100	25	1.5	53	30.5		
	100	25	1.5	53	30.5		
50	80	16	1	22	16.2	5000	
	80	16	1	22	16.2		
	110	27	2	61.8	37.9		
	110	27	2	61.8	37.9		
	110	27	2	61.8	37.9		
70	110	20	1.1	38.6	30.6	3600	
	110	20	1.1	38.6	30.6		
	125	24	1.5	62.2	44		
80	125	22	1.1	47.5	39.8	3500	
	170	39	2.1	120	83.9		
	170	39	2.1	120	83.9		

Bearing Designations		Mounting Dimensions			Mass
Present	Original	d _{amin}	D _a _{max}	r _a _{max}	
mm					
kg					
6009 E-RZ		50	70	1	0.227
6009 E-2RZ		50	70	1	0.234
6209 E-RS	160209E	51.5	78.5	1	0.389
6209 E-2RS	180209E	51.5	78.5	1	0.417
6309 E-RZ	160309EK	53	92	1.5	0.845
6309 E-2RZ	180309EK	53	92	1.5	0.845
6309 E-RS		53	92	1.5	0.846
6309 E-2RS		53	92	1.5	0.846
6010 E-RS	160110E	55	75	1	0.252
6010 E-2RS	180110E	55	75	1	0.26
6310 E-RS	160310E	59	101	2	1.07
6310 E-2RS	180310E	59	101	2	1.07
6311 E-2RZ	180311E	59	101	2	1.07
6014 E-RS		76.5	103.5	1	0.563
6014 E-2RS		76.5	103.5	1	0.585
6214E-RS					1.1
6016-2RS		86	119	1	0.822
6316-RZ	160316K	91	159	2	3.61
6316-2RZ	180316K	91	159	2	3.61



Self-Aligning Ball Bearings

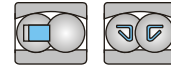

..... 145

Self-Aligning Ball Bearings

Self-Aligning Ball Bearings

LYC's self-aligning ball bearing has a spherical raceway in the outer ring and a double-raceway in the inner ring. This feature gives the bearings the self-aligning property, which can keep the machine operating well even when angular misalignment of the shaft relative to the housing occurs. Values of permissible misalignment errors of double row self-aligning ball bearings are given in the section "selection of bearing type".

The self-aligning ball bearing is mainly used to carry radial loads and light axial loads, but they can not carry pure axial loads.

Basic Structure

The self-aligning ball bearings of LYC's standard design are available with a cylindrical bore and with a taper bore (taper 1:12). Self-aligning ball bearings can be directly located on the taper journal with lock nut and can also be mounted on the cylindrical shaft with suitable adapter or withdrawal sleeve. The internal radial clearance of bearings can be adjusted by adapter sleeve. LYC can provide other structures of self-aligning ball bearings for customers, such as sealed self-aligning bearing, self-aligning ball bearing with extended inner ring etc. All types can not be listed in this catalogue. If customers require these, then please consult LYC technical department.

Cage

LYC self-aligning ball bearings are supplied with a pressed steel cage, a machined solid cage or glass fiber reinforced polyimide 66 and brass solid cage.

Axial Load Carrying Capacity

Self-aligning ball bearings with adapter sleeve normally will be fixed on a plain shaft without a shoulder. Axial load depends on friction between shaft and adapter sleeve. The allowed maximum axial load can be calculated from

$$F_p = 0.003Bd$$

where

- F_p — Allowed max axial load, KN
- B — Bearing width, mm
- d — Bearing inner diameter, mm

Minimum Load

In order to keep bearings working in a good condition, a minimum load must be imposed on bearings, particularly on bearings working at high speeds, high accelerations, or with the load direction changing frequently, because under these working conditions, inertial force of balls and cage and lubricant friction will have bad influence on the rotation of bearings, and detrimental sliding movement may be caused.

The minimum axial load of a self-aligning ball bearing can be obtained from

$$F_{min} = 0.01C_0$$

Where

C_0 — Basic static load rating, KN

When bearings are started at low ambient temperatures or in the condition where the viscosity of lubricant is very high, a larger minimum load probably is needed. Usually, the weight of bearing supporting parts plus the load on the bearing have been over the minimum load. If the weight can't be up to the required minimum load, then extra radial load must be imposed on this type of bearing in order to meet the requirement of minimum load, e.g. increase the tension for driving belt, or other similar methods.

Dimension, Tolerance, Clearance

The boundary dimension of LYC standard self-aligning ball bearing is according to GB/T273.3 <Rolling Bearing, Radial Bearing, and Boundary Dimension General Specification>, GB/T281 <Rolling Bearing, Self-aligning Ball Bearing, and Boundary Dimension>.

The tolerance of the LYC standard self-aligning ball bearing is according to GB/T307.1 <Rolling Bearing, Radial Bearing and Tolerance>.

The clearance of LYC standard self-aligning ball bearing is according to GB/4604 <Rolling Bearing, Radial Clearance>.

The dimensional tolerance of LYC standard self-aligning ball bearing is usually the normal grade P0 and the clearance is group 0. If customers have other special requirements on dimension, tolerance, and clearance, then LYC have the ability to supply the corresponding bearings to meet customer needs.

Equivalent Dynamic Load

The equivalent dynamic load of self-aligning bearing can be calculated from

$$\begin{aligned} \text{when } F_a/F_r \leq e & \quad P = F_r + Y_1 F_a \\ \text{when } F_a/F_r > e & \quad P = 0.65 F_r + Y_2 F_a \end{aligned}$$

Equivalent Static Load

The equivalent static load of self-aligning ball bearing can be calculated from.

$$P_0 = F_r + Y_0 F_a$$

where

- F_r — Radial load, N
- F_a — Axial load, N
- Y_1, Y_2 — Radial load factor
- Y_0 — Axial load factor

Coefficients e, Y_0, Y_1 and Y_2 are listed in bearing dimension table.

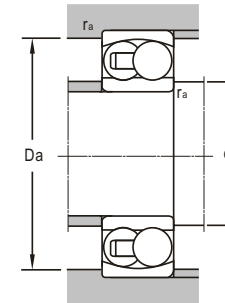
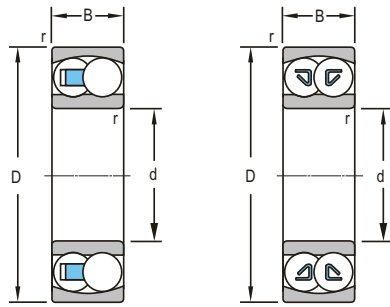

d 17~60mm

Boundary Dimensions				Basic Load Ratings		Limiting Speeds	
d	D	B	r _{min}	Dynamic C	Static C ₀	Grease	Oil
mm				kN		r/min	
17	40	12	0.6	0.6	2.45	13500	16200
20	47	14	1	1	3.2	13500	16200
	52	21	1.1	1.1	4.75	10000	13000
25	52	15	1	1	4.05	11700	14400
	52	18	1	1	4.28	11700	14400
	62	17	1.1	1.1	6	8500	11000
	62	24	1.1	1.1	6.95	8500	11000
30	62	16	1	1	5.85	9000	11700
	62	16	1	1	5.85	9000	11701
	62	20	1	1	5.68	9500	11700
	72	19	1.1	1.1	7.8	8100	10000
35	72	17	1.1	1.1	6.7	8100	10000
	72	23	1.1	1.1	8.6	8100	10000
	80	21	1.5	1.5	9.8	6800	8100
	80	31	1.5	1.5	12.9	6800	8100
40	80	18	1.1	1.1	8.65	6800	8100
	80	23	1.1	1.1	9.8	6800	8100
	90	23	1.5	1.5	12.2	6000	7200
	90	33	1.5	1.5	15.6	6000	7200
45	85	19	1.1	1.1	9.65	6000	7200
	85	23	1.1	1.1	10.8	6000	7200
	100	25	1.5	1.5	16	5700	6800
	100	36	1.5	1.5	19.6	5700	6800
50	90	20	1.1	1.1	10.8	6300	7700
	90	23	1.1	1.1	11.2	6300	7700
	110	27	2	2	17.6	5000	6000
	110	40	2	2	20	5000	6000
55	100	21	1.5	1.5	13.4	5000	6000
	120	29	2	2	22.4	4500	5400
	120	43	2	2	24	4500	5400
60	110	22	1.5	1.5	15.6	5000	6000
	110	28	1.5	1.5	16.8	5000	6000

Bearing Designations				Mounting Dimensions			Calculation Factors				Mass
Cylindrical Bore	Tapered Bore	Cylindrical Bore	Tapered Bore	d _{amin}	D _{amax}	r _{amax}	e	Y ₁	Y ₂	Y ₀	
Present	Original	Original	Original	mm							kg
1203	1203K	1203	111203	21	36	0.6	0.31	2	3.1	2.2	0.076
1204	1204 K	1204	111204	25	42	1	0.27	2.3	3.6	2.4	0.119
2304	2304K	1604	111604	26.5	45.5	1	0.51	1.2	1.9	1.3	0.219
1205	1205 K	1205	111205	30	47	1	0.27	2.3	3.6	2.4	0.144
2205	2205 K	1505	111505	30	47	1	0.41	1.5	2.3	1.5	0.187
1305	1305 K	1305	111305	31.5	55.5	1	0.27	2.3	3.5	2.4	0.258
2305	2305K	1605	111605	31.5	55.5	1	0.47	1.3	2.1	1.4	0.354
1206	1206 K	1206	111206	35	57	1	0.24	2.6	4	2.7	0.227
1206TN1				35	57	1	0.24	2.6	4	2.7	0.224
2206	2206 K	1506	111506	35	57	1	0.39	1.6	2.4	1.7	0.26
1306	1306 K	1306	111306	36.5	65.5	1	0.34	2.4	3.8	2.6	0.39
1207	1207 K	1207	111207	41.5	65.5	1	0.23	2.7	4.2	2.9	0.347
2207	2207 K	1507	111507	41.5	65.5	1	0.38	1.7	2.6	1.8	0.441
1307	1307 K	1307	111307	43	72	1.5	0.25	2.6	4	2.7	0.538
2307	2307 K	1607	111607	43	72	1.5	0.46	1.4	2.1	1.4	0.675
1208	1208 K	1208	111208	46.5	73.5	1	0.22	2.9	4.4	3	0.419
2208	2208 K	1508	111508	46.5	73.5	1	0.34	1.9	2.9	2	0.53
1308	1308 K	1308	111308	48	82	1.5	0.24	2.6	4	2.7	0.711
2308	2308 K	1608	111608	48	82	1.5	0.43	1.5	2.3	1.5	0.93
1209	1209 K	1209	111209	51.5	78.5	1	0.21	2.9	4.6	3.1	0.493
2209	2209 K	1509	111509	51.5	78.5	1	0.31	2.1	3.2	2.2	0.553
1309	1309 K	1309	111309	53	92	1.5	0.25	2.5	3.9	2.6	0.951
2309	2309 K	1609	111609	53	92	1.5	0.42	1.5	2.3	1.6	1.25
1210	1210 K	1210	111210	56.5	83.5	1	0.2	3.1	4.8	3.3	0.545
2210	2210 K	1510	111510	56.5	83.5	1	0.29	2.2	3.4	2.3	0.678
1310	1310 K	1310	111310	59	101	2	0.24	2.7	4.1	2.8	1.21
2310	2310 K	1610	111610	59	101	2	0.43	1.5	2.3	1.6	1.66
1211	1211 K	1211	111211	63	92	1.5	0.2	3.2	5	3.4	0.704
1311	1311 K	1311	111311	64	111	2	0.23	2.7	4.2	2.8	1.58
2311	2311 K	1611	111611	64	111	2	0.41	1.5	2.4	1.6	2.09
1212	1212 K	1212	111212	68	102	1.5	0.19	3.4	5.3	3.6	0.896
2212	2212 K	1512	111512	68	102	1.5	0.28	2.3	3.5	2.4	1.15

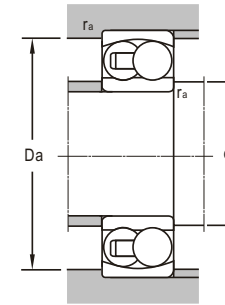
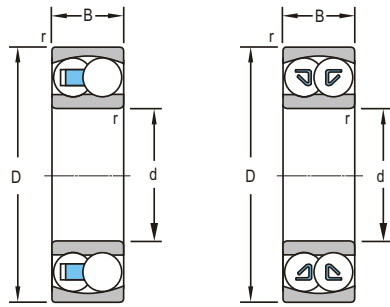

d 60~750mm

Boundary Dimensions				Basic Load Ratings		Limiting Speeds	
<i>d</i>	<i>D</i>	<i>B</i>	<i>r_{min}</i>	Dynamic <i>C</i>	Static <i>C₀</i>	Grease	Oil
mm				kN		r/min	
60	130	31	2.1	57.2	26.5	4050	5000
	130	46	2.1	87.1	28.5	4050	5000
65	140	33	2.1	63.7	29	3870	4500
70	150	35	2.1	74.1	27.5	3600	4320
75	160	37	2.1	79.3	30	3400	4300
	160	55	2.1	124	43	3400	4300
80	170	39	2.1	88.4	33.5	3200	4100
85	180	41	3	97.9	38	3100	3600
750	920	78	5	276	307	260	340

Bearing Designations				Mounting Dimensions			Calculation Factors				Mass
Cylindrical Bore	Tapered Bore	Cylindrical Bore	Tapered Bore	<i>d_{amin}</i>	<i>D_{amax}</i>	<i>r_{amax}</i>	<i>e</i>	<i>Y₁</i>	<i>Y₂</i>	<i>Y₀</i>	
Present	Original	Original	Original	mm							kg
1312	1312 K	1312	111312	71	119	2	0.23	2.8	4.3	2.9	1.96
2312	2312 K	1612	111612	71	119	2	0.41	1.6	2.5	1.6	2.58
1313	1313 K	1313	111313	76	129	2	0.23	2.8	4.3	2.9	2.38
1314	1314 K	1314	111314	81	139	2	0.22	2.8	4.4	2.9	2.98
1315	1315 K	1315	111315	86	149	2	0.22	2.8	4.4	3	3.55
2315	2315 K	1615	111615	86	149	2	0.38	1.7	2.6	1.7	4.71
1316	1316	1316	111316	91	159	2	0.22	2.9	4.5	3.1	4.17
1317	1317	1317	111317	98	167	2.5	0.22	2.9	4.5	3	4.95
118/750	118/750 K	118/750	11118/750	761	909	4	0.059	10.6	16.4	11.1	116

Cylindrical Roller Bearings

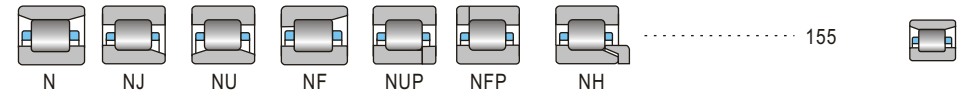

Single Row Cylindrical Roller Bearings

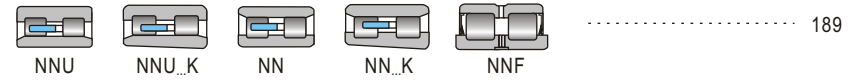

Double-Row Cylindrical Roller Bearings

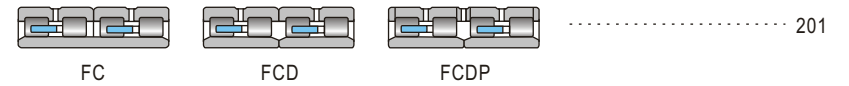

Four-Row Cylindrical Roller Bearings



Cylindrical Roller Bearings

Most of LYC's cylindrical roller bearings are separable. This makes it very convenient to mount and dismount. Cylindrical roller bearings can carry heavier radial load, and are suitable to be used in the condition of high speed.

This type of bearings can allow a small angular error between inner axes and outer axes in the range of 2' ~ 4'. Therefore, it requires higher machining precision on shaft and housing; otherwise, asymmetrical load and stress would be focused at the position of raceway. However, this situation can be improved by correcting the contacted generatrix of rollers or raceways. According to different rows, LYC's cylindrical roller bearings are divided into single row, double-row, and multi-row cylindrical rollers. These differences are also displayed on the design of flange position. The common used types of LYC's cylindrical roller bearings are as follows.

Single Row Cylindrical Roller Bearings Type N, NU

Bearings of type N have two integral flanges on inner ring and a flangeless outer ring. This type of bearings permits axial displacement in double directions of the housing relative to the shaft. The bearings of type NU have two integral flanges on outer ring and a flangeless inner ring. This type of bearings permits axial displacement in double directions of the housing relative to the shaft. Therefore, this type of bearings is suitable to be used as non-locating bearings.

Type NJ, NF

Bearings of type NJ have two integral flanges one on the outer ring, and one on the inner ring. This type of bearing can carry a certain amount of axial load in a single direction. Bearings of type NF have one flange on the outer ring, and two integral flanges on the inner ring. This type of bearing can carry a certain amount of axial load in a single direction. Therefore, they are suitable to be used as an axial location bearing in single direction.

Type NUP, NFP

Bearings of type NUP have two integral flanges on outer ring, one flange and separable loose flange on inner ring. This type of bearing can

carry a certain amount of axial loads in double directions.

Bearings of type NFP have one flange, a loose flange on outer ring, and two integral flanges on inner ring. This type of bearing also can carry a certain amount of axial loads in double directions. This type of bearing can limit the displacement in double directions of the housing relative to the shaft.

Therefore, they are suitable to be used as a locating bearing.

Type NH (NJ+HJ)

Bearings of type NH are combined by the bearing of type NJ and the bearing of type HJ with catercornered flange. Comparing to NUP type with short flange ring and non-locating loose flange, type NH can take the advantage of the whole inner ring width of NJ to match with axes tightly. Moreover, it's quite convenient to mount and dismount.

This type of bearings can limit axial displacement in double directions of the housing relative to the shaft. Therefore, they are suitable to be used as a locating bearing.

Double-Row Cylindrical Roller Bearings

LYC's double-row cylindrical roller bearings are divided into bearings with cylindrical inner bore and tapered inner bore (added K behind bearing type). This type of bearing has these advantages, such as compact structure, good rigidity, heavy load carrying capacity, and little distortion under loads. Consequently, it's applicable for the machine tool spindle. Tapered inner bore could fine adjust clearance, simplify positioning fixture and be convenient to mount and dismount. The common used types of LYC's double-row cylindrical roller bearings are as follows.

Type NN, NNU

Bearings of type NN have two integral flanges on the inner ring, a flangeless outer ring and a centre flange in the middle. This type of bearing permits axial displacement in double directions of the housing relative to the shaft.

The bearings of type NNU have two integral flanges on the outer ring, a non-contacting inner ring and a centre flange in the middle. This type of bearing permits axial displacement in double directions of the housing relative to the shaft.

Therefore, this type of bearing is suitable to be used as non-locating bearings.

Type NNF

Bearings of type NNF are one kind of double-row cylindrical roller bearings full of rollers, which consist of the outer ring with a center flange, two inner rings with double flanges. Rollers are guided by flanges on inner ring, and two inner rings are fixed up by a fastening ring. This structure can carry not only considerable radial load and axial load, but also tilting moment. Therefore, they are suitable to be used as non-locating bearings. Bearings of type NNF have contact seals at two sides. And they are filled with grease lubricant, whose working temperature would be -50°C ~ +110°C. However, after considering the seal material, available working temperature shall be -40°C ~ +80°C. Under appropriate conditions, sealed NNF bearing require little maintenance and can be kept for long periods in water vapor or polluted environment. When at mid or high speed, bearing can get make-up lubricating through lubrication groove and bore.

Four-Row Cylindrical Roller Bearings

LYC's four-row cylindrical roller bearings are mainly used for rolling mill. The bearing are separable, i.e. the rings and rolling elements could be separated. Therefore it is convenient to wash, check, mount and dismount.

Type FC

The bearings of type FC consist of two outer rings and one inner ring, which have two integral flanges on outer rings, a center flange in the middle and a flangeless inner ring.

Type FCD

Essentially, bearing of type FCD consists of two bearings of type NN.

Bearings of type FC and FCD can permit axial displacement in double directions of the housing relative to the shaft

Therefore, they are suitable to be used as non-locating bearings. Normally, their cages are made from solid machinery.

Special Design The Structure of Type E

Comparing to the former bearings with the same types, the internal structures have been improved so as to increase bearing carrying capacity and life. In order to distinguish with the former design, E will be added behind the bearing type.

Tapered Bore Bearing

LYC's single row and double-row cylindrical roller bearings normally have cylindrical inner holes. But for some parts of the dimensions and specifications, tapered holes (taper: 1:12) can also be provided. In this case, K would be added behind the bearing type.

Bearings with Snap Ring Groove

LYC can also supply single row cylindrical roller bearings with snap ring groove on inner ring. This type of bearings can be located through the snap ring. While mounting, it is convenient to fix the bearing into the housing. Consequently, it could be taken into consideration when the mounting position is limited. In this case, N should be added behind the bearing type.

LYC can also provide customers cylindrical roller bearings with other structures, such as insulative cylindrical roller bearings, cylindrical roller bearings without inner ring or outer ring, cylindrical roller bearings full of rollers, and sealed etc. All types can not be listed in this catalogue. If customers require, please consult LYC technical department.

Cage

Most cages for LYC's single row cylindrical roller bearings are pressed steel cages or machined brass cages. According to different working conditions and customers' requirements, cages with other design and structure could be supplied, e.g. glass fiber reinforced polyamide 66, which can work continuously at the maximum temperature +120°C.

Under continuous high temperatures or bad conditions, steel pressed cages and machined brass cages are recommended for single row cylindrical roller bearings.

Normally cage materials of LYC's double (four)-row cylindrical roller bearings are machined brass cages. For bearings with extra-large size, welded steel cages also can be selected.

Axial Dynamic Load Carrying Capacity

LYC's cylindrical roller bearings with designed flanges on inner and outer ring can carry not only radial load but also a certain amount of axial loads. The axial load carrying capacity mainly depends on the form of interface between roller end face and flange, lubricating conditions, and heat dissipation, etc.

Based on the following supposed conditions, the permissible axial load can be calculated from

$$F_{max} = \frac{K_1 C_0 10^4}{n(d+D)} - K_2 F_r$$

where

- F_{max} — Max permissible axial load, kN
- C_0 — Basic static load rating, kN
- F_r — Actual radial load, kN
- n — Speed, r/min
- $d(D)$ — Bearing inner diameter(outer diameter), mm
- K_1 — Factor, oil lubricating is 1.5, grease lubricating 0.5
- K_2 — Factor, oil lubricating is 0.3, grease lubricating 0.15

The above formula is based on the temperature difference of 60°C between working and ambient temperature, and the viscosity ratio ≥ 2 .

Note that this formula will not be applicable in the case of roller end face or flange with special design.

In order to avoid flange cracking, LYC technical department advises that the axial load F_a (frequently or occasionally) cannot be larger than the following value:

$$F_a = 0.0023D^{1.7} \text{ kN}$$

- D — Bearing outer diameter, mm

The axial load F_a acting on bearings in a short time or occasionally can not be larger than the following value:

$$F_a = 0.007D^{1.7} \text{ kN}$$

- D — Bearing outer diameter, mm

When single row cylindrical roller bearings carry heavy axial load, the loads need to be distributed equally. In addition, a certain rotating precision, dimension of shaft shoulder and axial runout should be reached. The related axial runout of shaft shoulder can be referred to "Bearing application".

When axial load and deflexion happen at the same time, the height of the shaft shoulder of supporting inner ring should be one half of the flange, see Fig.1. In order to avoid the flange

carrying circular stress, the shaft shoulder diameter can be calculated from

$$d_a = 0.5(d_1 + F)$$

where

- d_a — Shaft shoulder diameter, mm
- d_1 — Flange diameter of inner ring, mm
- F — Raceway diameter of inner ring, mm

When axes angular error between inner ring and outer ring exceed 1', the load carrying capacity on the flange shall be changed extremely. In that case, safe coefficient as above may not be suitable. In this case, please consult LYC technical department.

To ensure cylindrical roller bearing is working in good condition under axial loads, especially heavy axial loads, LYC technical department suggests to notice the following several points:

- Internal radial clearance should be controlled within the required range, and small clearance is preferred to big.
- Please use lubricant with extreme pressure additive.

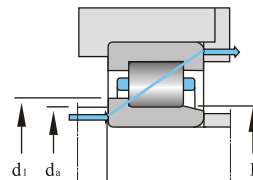

Fig 1

Minimum Load

In order to keep bearings working in good condition, a minimum load must be imposed on bearings, particularly on bearings working at high speeds, high accelerations, or with the load direction changing frequently, because under these working conditions, inertial force of balls and cage and lubricant friction will have bad influence on the rotation of bearings, and detrimental sliding movement may be caused. The minimum load of a cylindrical roller bearing can be obtained from

$$F_{min} = K_r \left(6 + \frac{4n}{n_{limit}} \right) \left(\frac{dm}{100} \right)^2$$

where

- n — Working speed, r/min
- n_{limit} — Limiting speed, r/min
- dm — Mean bearing diameter $dm=0.5(d+D)$, mm

K_r — Minimal load factors, the values are Listed in the table below

K_r	Dimension Series			
	10	2、3、4	22	23
	100	150	200	250

When bearings are started at low ambient temperatures or in the condition that the viscosity of the lubricant is very high, bigger minimum load is required. Usually, the weight of the bearing supporting parts plus the load on the bearing have been over the required minimum load. If the weight cannot be up to the minimum load, extra radial load must be exerted on this type of bearing in order to meet the requirement of minimum load.

Dimension, Tolerance, Clearance

LYC's standard cylindrical roller bearing dimension is in accordance to GB/T273.3 <Rolling Bearing, Radial Bearing, and Boundary Dimension General Specification>, GB/T283 <Rolling Bearing, Cylindrical Roller Bearing, and Boundary Dimension>, GB/T285 <Rolling Bearing, Double-Row Cylindrical Roller Bearing, and Boundary Dimension>, JB/T5389.1 <Rolling Bearing, Four-Row Cylindrical Roller Bearing Used by Rolling Mill>. <Rolling Bearing, Radial Bearing, and Boundary Dimension General Specification>, GB/T283 <Rolling Bearing, Cylindrical Roller Bearing, and Boundary Dimension>, GB/T285 <Rolling Bearing, Double-Row Cylindrical Roller Bearing, and Boundary Dimension>, JB/T5389.1 <Rolling Bearing, Four-Row Cylindrical Roller Bearing Used by Rolling Mill>.

The tolerance of LYC's standard cylindrical roller bearing is in accordance to GB/T307.1 <Rolling Bearing, Radial Bearing, and Tolerance>.

The clearance of LYC's standard cylindrical roller bearing is in accordance to GB/T4604 <Rolling Bearing, and Radial Clearance>.

The dimensional tolerance of LYC's standard cylindrical roller bearing is the normal grade P0 and the clearance is group 0. If customers have other special requirements on dimension, tolerance, and clearance, LYC have the ability to supply the corresponding products, including non-standard products.

Equivalent Dynamic Load

For cylindrical roller bearings carrying dynamic loads, when applied as wandering end bearings, the equivalent dynamic load can be calculated as

following

$$P = F_r$$

If the bearing carries axial load in one direction or double directions, the equivalent dynamic load can

when $F_a/F_r \leq e$ $P = F_r$

when $F_a/F_r > e$ $P = 0.92F_r + YF_a$

e — Limiting value

For dimension series 2, 3, 4, $e=0.2$,

For other series $e=0.3$

Y — Axial load coefficient

For dimension series 2, 3, 4, $Y=0.6$,

For other series $Y=0.4$

In order to obtain ideal effect, cylindrical roller bearing needs to carry axial load and radial load at the same time. However, the ratio of axial load and radial load should be smaller than 0.5.

Equivalent Static Load

For the cylindrical roller bearing carrying static load, the equivalent static load can be calculated from

$$P_0 = F_r$$



single row

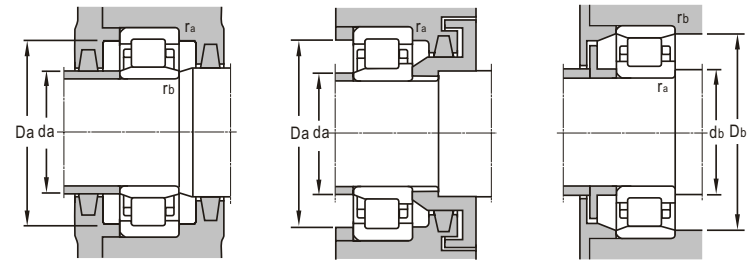
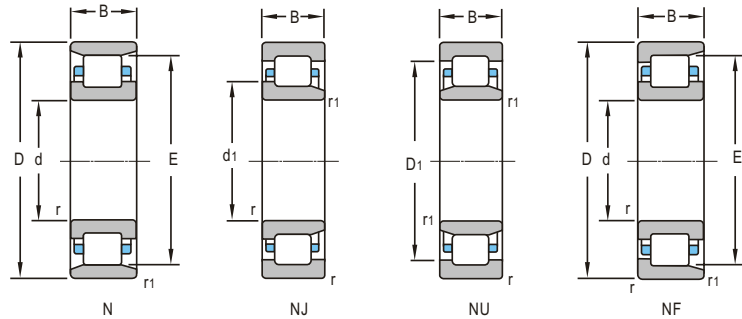

d 17~35mm

Boundary Dimensions					Basic Load Ratings		Limiting Speeds	
d	D	B	r _{min}	r _{1min}	Dynamic C	Static C ₀	Grease	Oil
mm					kN		r/min	
17	47	14	1	0.6	19.2	16.9	14000	17000
18	52	15	0.6	0.6	30.8	25.4	10000	14000
20	47	14	1	0.6	23.8	23.9	13000	16000
	47	14	1	0.6	25.1	25.2	13000	16000
	47	14	1	0.6	25.1	25.2	13000	16000
25	52	15	1	0.6	28.8	27.1	11000	14000
	52	15	1	0.6	30.6	29.3	10500	13500
	52	15	1	0.6	30.6	29.3	11000	14000
	52	15	1	0.6	28.8	27.1	11000	14000
	52	15	1	0.6	28.8	27.1	11000	14000
	52	18	1	0.6	37.8	40.2	2200	4500
	62	17	1.1	1.1	36.9	32	9500	12000
	62	17	1.1	1.1	30.6	26.6	9500	12000
	62	17	1.1	1.1	38	37	9500	12000
	62	17	1.1	1.1	38.2	34.7	2500	5000
	62	17	1.1	1.1	38	37	9500	12000
	62	24	1.1	1.1	50.5	49.5	9000	11000
	62	24	1.1	1.1	58.4	62.2	2200	4500
27	58	18	1.1	1.1	50	55	11000	14000
30	62	16	1	0.6	34.3	21.7	9500	12000
	62	16	1	0.6	34.3	21.7	9500	12000
	62	16	1	0.6	34.3	21.7	9500	12000
	62	16	1	0.6	26.5	25.3	9500	12000
	62	16	1	0.6	26.5	25.3	9500	12000
	62	16	1	0.6	32.9	29.7	9500	12000
	62	16	1	0.6	26.5	25.3	9500	12000
	62	16	1	0.6	26.5	25.3	9500	12000
	62	16	1	0.6	36.1	34.7	10810	13620
	62	16	1	0.6	36.1	34.7	10810	13620
	62	16	1	0.6	36.1	34.7	10810	13620
	62	16	1	1	36.1	34.7	9000	11500
	72	19	1.1	1.1	51.2	48	9000	11000
	72	19	1.1	1.1	51.2	48	9000	11000
35	72	17	1.1	0.6	45.3	43.8	8500	10000
	72	17	1.1	0.6	45.3	43.8	8500	10000

Bearing Designations		Journal	Other Dimensions				Mounting Dimensions					Mass
Present	Original		d ₁	D ₁	E	F	d _{amin}	D _{amax}	d _{bmin}	r _{amax}	r _{0max}	
		mm	mm									kg
NU 303M	32303H	17		36.8		27	21.2	41	1	0.6		0.147
NB 3/18 JR/YA4	822903	18				25	23	47	0.6	0.6		0.1756
N 204	2204	20	30.4		40			43	1	0.6		0.112
NU 204M	32204H	20		36.8		27	24	42	1	0.6		0.112
NJ 204M	42204H	20	30	36.8		27	24	42	1	0.6		0.135
NU 205M	32205H	25		41.8		32	29	47	1	0.6		0.168
NJ 205 EF1		25	34.7	43.5		31.5	29	47	1	0.6		0.146
NJ 205 ETN1	42205EA	25	34.7	43.5		31.5	29	47	1	0.6		0.135
NJ 205 EM		25	34.7	43.5		31.5	29	47	1	0.6		0.152
NU 205 EM		25		43.5		31.5	29	47	1	0.6		0.15
NU 2205 V/C9	3-258	25		41.12		31.12	29	47	1	0.6		0.178
NJ 305 E	42305E	25	38.1	50.4		34	31	55	1	1		0.256
NJ 305		25	38.6	48.7		35	31	55	1	1		0.255
NJ 305 ETN1	42305EA	25	38.1	50.4		34	31	55	1	1		0.251
NCL 305 V	102305	25	39		53		31		55	1	1	0.254
NU 305 M		25		50.4		34	32	55	1	1		0.273
NJ 2305M	42605 HY	25	39	48.7		35	32	55	1	1		0.452
NCL 2305 V	102605	25	39		53		32		52	1	1	0.351
NU 6/27 EV		27		47.6		35.53	33	53	1	1		0.23
N 206 E	2206E	30	41.3		55.5		35		57	1	0.6	0.205
NJ 206 E	42206E	30	41.3	52.3		37.5	35	57	1	0.6		0.213
NU 206 E	32206E	30		52.3		37.5	35	57	1	0.6		0.207
N 206	2206	30	42.1		53.5			57	1	0.6		0.219
NU 206M	32206H1	30		49.9		38.5	34	57	1	0.6		0.239
NU 206EM		30		52.3		37.5	34	57	1	0.6		0.223
NU 206Q1PS	32206Q1	30		49.9		38.5	34	57	1	0.6		0.238
NJ 206M	42206H1	30	41.8	49.9		38.5	34	57	1	0.6		0.247
N 206 ETN1	2206EA	30	41.3		55.5			57	1	0.6		0.205
NU 206 ETN1	32206EA	30		52.3		37.5	34	57	1	0.6		0.207
NJ 206 ETN1	42206EA	30	41.3	52.3		37.5	34	57	1	0.6		0.213
NJ 206 EF1		30	41.3	52.3		37.5	34	57	1	0.6		0.31
NF 306 E	12306E	30	44.9	58.9		62.5	37	65	1	1		0.377
NU 306 EM		30		58		40.5	37	65	1	1		0.399
NJ 207 EM		35	48	60		44	39	65	1	0.6		0.337
NU 207 EM		35		60		44	39	65	1	0.6		0.328



single row

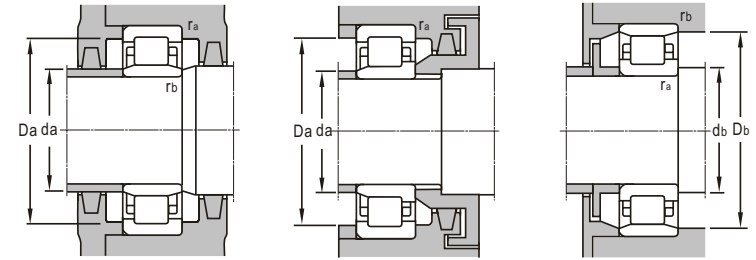
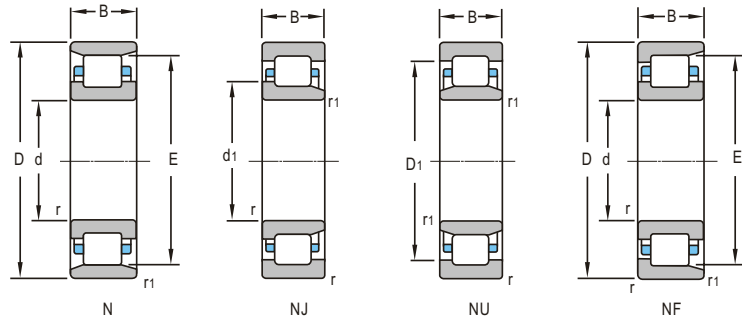

d 35~45mm

Boundary Dimensions					Basic Load Ratings		Limiting Speeds	
d	D	B	r _{min}	r _{1min}	Dynamic C	Static C ₀	Grease	Oil
mm					kN		r/min	
35	72	17	1.1	0.6	49.2	51.9	9340	11770
	80	21	1.5	1.1	50.9	48.5	7000	8500
	80	21	1.5	1.1	50.9	48.5	7000	8500
	80	21	1.5	1.1	50.9	48.5	7000	8500
	80	21	1.5	1.1	59.1	39.2	8000	9500
	80	21	1.5	1.1	70.6	66.2	7000	8500
	80	21	1.5	1.1	70.6	66.2	7000	8500
	80	21	1.5	1.1	80.2	83.3	2500	3050
	80	21	1.5	1.1	80.2	83.3	2500	3050
	80	31	1.5	1.1	64.8	66.1	7000	8500
	80	31	1.5	1.1	92.2	99.3	7000	8500
	80	31	1.5	1.1	92.2	99.3	7000	8500
	100	25	1.5	1.5	77.5	72.5	6700	8000
	40	80	18	1.1	1.1	49.1	31.9	7500
80		18	1.1	1.1	49.1	31.9	7500	9000
80		18	1.1	1.1	49.1	31.9	7500	9000
80		18	1.1	1.1	48.5	47.7	7500	9000
80		18	1.1	1.1	48.5	47.7	7500	9000
80		18	1.1	1.1	48.5	47.7	7500	9000
80		18	1.1	1.1	48.5	47.7	7500	9000
80		18	1.1	1.1	48.5	47.7	7500	9000
80		18	1.1	1.1	51.2	50.4	8330	10500
80		18	1.1	1.1	51.2	50.4	8330	10500
80		18	1.1	1.1	51.2	50.4	8330	10500
90		23	1.5	1.5	59.8	58.4	6700	8000
90		23	1.5	1.5	59.8	58.4	6700	8000
90		23	1.5	1.5	59.8	58.4	6700	8000
90		23	1.5	1.5	59.8	58.4	6700	8000
90		23	1.5	1.5	83.6	88.4	6700	8000
90		23	1.5	1.5	98.9	103	6700	8000
90		23	1.5	1.5	59.8	58.4	6700	8000
90		23	1.5	1.5	59.8	58.4	6700	8000
90		23	1.5	1.5	87.7	87.4	6500	7500
90	33	1.5	1.5	111	119	6300	7500	
110	27	2	2	106	102	6000	7000	
45	85	19	1.1	1.1	60.1	62.5	6700	8000
	85	19	1.1	1.1	64.3	68.1	6700	8000
	85	23	1.1	1.1	66.1	79.5	6700	8000

Bearing Designations		Journal	Other Dimensions				Mounting Dimensions					Mass	
Present	Original		d ₁	D ₁	E	F	d _{amin}	D _{amax}	d _{bmin}	r _{amax}	r _{0max}		
		mm						mm					kg
N 207 ETN1	2207 EA	35	48.3		64		42		67.8	1.1	0.6	0.296	
	32307H	35		63.5		46.2	43	72		1.5	1	0.546	
	NF 307	35	51.5	64	68.2		43		72	1.5	1	0.509	
	NJ 307	42307	35	50.8	63.5		46.2	43	72	1.5	1	0.505	
	NJ 307 E	42307E	35	51.1	66.3		46.2	43	72	1.5	1	0.482	
	NJ307ETN1	42307EA	35	51.1	66.3		46.2	43	72	1.5	1	0.482	
	NJ 307 EF1		35	51.1	66.3		46.2	43	72	1.5	1	0.676	
	NJ307ENV/C9		35	52.2	64.4		46.2	44	72	1.5	1	0.531	
	NJ 307 EV		35	52.2	64.4		46.2	44	72	1.5	1	0.537	
	NJ 2307	42607H	35	50.8	63.5		46.2	42	72	1.5	1	0.876	
	NJ2307EF1		35	55.1	66.3		46.2	42	72	1.5	1	0.936	
	NU2307EF1		35		66.3		46.2	42	72	1.1	1	0.917	
	NJ 407 M		35	59	78.1		53	44	92	1.5	1.5	1.14	
	NJ 208 E	42208E	40	54.2	67.6		49.5	47	73		1	1	0.395
NF 208 E		12208E	40	54.2	67.6	71.5	47		72	1	1	0.392	
NU 208 E		32208E	40		67.6		47	70		1	1	0.383	
N 208 M		2208H	40	54.6		70	47		73	1	1	0.439	
N 208		2208	40	54.6		70	47		73	1	1	0.394	
NF 208		12208	40	54.6	66	70	47	73		1	1	0.404	
NU 208M		32208H1	40		65.6		50	47	73		1	1	0.448
NJ 208M		42208H1	40	54.2	65.6		50	47	73		1	1	0.458
NU 208 ETN1		42208EA	40		67.6		49.5	47	73		1	1	0.383
NJ 208 ETN1		42208EA	40	54.2	67.6		49.5	47	73		1	1	0.395
NF 208 ETN1		12208EA	40	54.2	67.6	71.5		47	73		1	1	0.392
N 308		2308	40	58.4		77.5		48		80	1.5	1.5	0.662
NU308Q1		32308Q	40		72.1		53.5	48	82		1.5	1.5	0.761
NU 308M		32308H	40		72.1		53.5	48	82		1.5	1.5	0.760
NU308L		32308L	40		72.1		53.5	48	82		1.5	1.5	0.694
NJ 308M		42308H	40	57.6	72.1		53.5	48	82		1.5	1.5	0.750
NU 308 EPC/P5			40		75.5		52	49	82		1.5	1.5	0.638
NJ 308 EV/C9YB2			40	59.5	76		53.46	48	82		1.5	1.5	0.693
NJ308L		42308L2	40	57.5	72.1		53.5	48	82		1.5	1.5	0.684
NF 308 M			40	58.4	72.5	77.5		49		80	1.5	1.5	0.674
NF308EF1		40	57.5	75	81.3		49		80	1.5	1.5	0.876	
NJ2308E		40	57.7	75.4		52	48	82		1.5	1.5	1.17	
N408M		40	66		92		50		93	2	2	1.44	
NJ 209 EM		45	59.2	72.6		54.5	53	78		1	1	0.49	
	NJ 209EF1		45	59.2	72.6		54.5	53	78		1	1	0.623
	NU 2209 L1		45		72.4		54.5	52	78		1	1	0.567



Cylindrical Roller Bearings

single row

LYC®

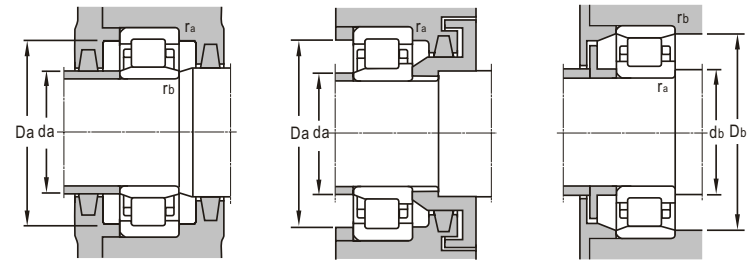
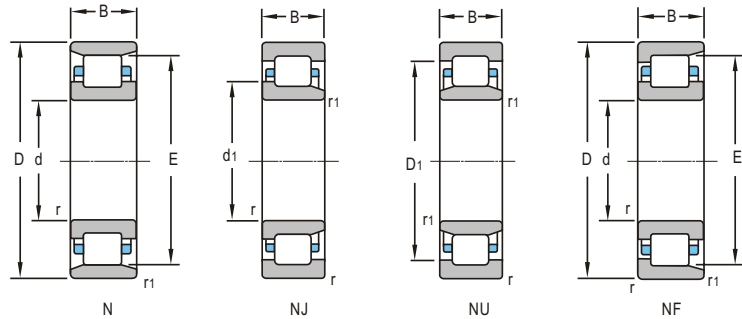

d 45~55mm

Boundary Dimensions					Basic Load Ratings		Limiting Speeds	
d	D	B	r _{min}	r _{1min}	Dynamic C	Static C ₀	Grease	Oil
mm					kN		r/min	
45	85	23	1.1	1.1	72.6	79.5	6700	8000
	85	23	1.1	1.1	72.6	79.5	6700	8000
	85	23	1.1	1.1	72.6	79.5	6700	8000
	100	25	1.5	1.5	101	103.0	6300	7500
	100	25	1.5	1.5	79.5	78.5	6300	7500
	100	25	1.5	1.5	79.5	78.5	6300	7500
	100	25	1.5	1.5	79.5	78.5	6300	7500
	100	25	1.5	1.5	79.5	78.5	6300	7500
	100	25	1.5	1.5	79.5	78.5	6300	7500
	100	31	1.5	1.5	130	149	5600	6700
	100	36	1.5	1.5	93.3	104	5600	6700
	120	29	2	2	117	115	5600	6700
50	90	20	1.1	1.1	52.3	56.8	6300	7500
	90	20	1.1	1.1	54.8	60.3	6300	7500
	90	20	1.1	1.1	54.8	60.3	6300	7500
	90	20	1.1	1.1	52.3	56.8	6300	7500
	90	20	1.1	1.1	54.8	60.3	6300	7500
	90	20	1.1	1.1	54.8	60.3	6300	7500
	90	20	1.1	1.1	59.9	63.4	6300	7500
	90	20	1.1	1.1	59.9	63.4	6300	7500
	90	23	1.1	1.1	64.1	69.1	6300	7500
	90	23	1.1	1.1	76.2	86.4	6300	7500
	110	27	2	2	90.4	90.7	5000	6000
	110	27	2	2	90.4	90.7	5000	6000
	110	27	2	2	90.4	90.7	5000	6000
	110	27	2	2	90.4	90.7	5000	6000
	110	27	2	2	90.4	90.7	5000	6000
	110	40	2	2	121	133	5000	6000
	110	40	2	2	153	172	5000	6000
	55	100	21	1.5	1.1	87	100	6000
100		21	1.5	1.1	87	100	6000	7000
100		21	1.5	1.1	87	100	6000	7000
100		21	1.5	1.1	87	100	6000	7000
120		29	2	2	110	110	4800	5600
120		29	2	2	110	110	4800	5600
120		29	2	2	110	110	4800	5600
120		29	2	2	110	110	4800	5600
120		29	2	2	110	110	4800	5600
120		29	2	2	140	146	4800	5600
120		43	2	2	148	162	4800	5600

Bearing Designations		Journal	Other Dimensions				Mounting Dimensions					Mass
Present	Original		d ₁	D ₁	E	F	d _{amin}	D _{amax}	d _{bmin}	r _{amax}	r _{0max}	
		mm	mm									kg
NJ 2209 EF1		45	59.2	72.6	54.5		52	78	1	1		0.767
NJ 2209 EM1		45	72.4	54.5			52	78	1	1		0.624
NU 2209 EM		45	72.4	54.5			52	78	1	1		0.63
NF309EF1		45	64.7	83.6	90		53	92	92	1.5	1.5	1.24
N 309	2309	45	64	86.5			53	92	89	1.5	1.5	0.876
NU 309M	32309H	45		80.2	58.5		53	92		1.5	1.5	1.01
NU 309L	32309L	45		80.2	58.5		53	92		1.5	1.5	0.9
NJ 309M	42309H	45	62.9	80.2	58.5		53	92		1.5	1.5	1.03
NJ 309L	42309L	45	62.9	80.2	58.5		53	92		1.5	1.5	0.922
NJ2309 X2V/C9		45	63.5	80.2	57.87		53	92		1.5	1.5	1.21
N 2309M	2609H	45	64	86.5			53	92	89	1.5	1.5	1.51
NJ 409 M		45	72	94	64.5		55	110	2	2		1.85
N 210	2210	50	64.6	80.4			56.5		83.5	1	1	0.513
NU 210M	32210H	50		76.25	60.4		56.5	83.5		1	1	0.564
NU 210L	32210L	50		76.25	60.4		56.5	83.5		1	1	0.51
NU 210Q1	32210Q1	50		76.25	60.4		56.5	83.5		1	1	0.546
NJ 210M	42210H	50	64	76.25	60.4		56.5	83.5		1	1	0.581
NJ 210L	42210L	50	64	76.25	60.4		56.5	83.5		1	1	0.527
NJ 210EM		50	64	77.6	59.5		56.5	83.5		1	1	0.577
NU 210EM		50		77.6	59.5		56.5	83.5		1	1	0.559
NU 2210 EM		50		77.6	59.5		56.5	83.5		1	1	0.625
NU 2210 EM1		50		78	59.5		56.5	83.5		1	1	0.648
N 310	2310	50	71	89.6	95		59		98	2	2	1.15
NU 310	32310	50		89.6	65		59	101		2	2	1.14
NU 310M	32310H	50		89.6	65		59	101		2	2	1.29
NJ 310	42310	50	70.2	89.6	65		59	101		2	2	1.17
NJ 310M	42310H	50	70.2	89.6	65		59	101		2	2	1.32
NU 2310M	32610H	50		88.1	65		59	101	101	2	2	2.01
NJ 2310 EM/C9S0		50	71	91.8	65		59	101		2	2	2.02
NJ 211 E	42211E	55	70.9	86.3	66		61.5	91		1.5	1	0.753
NJ 211 EF1		55	70.9	86.3	66		61.5	91		1.5	1	0.796
NF 211 E		55	70.9	86.5	90		61.5	91		1.5	1	0.741
NU 211 EF1		55		86.5	66		61.5	91		1.5	1	0.726
N 311	2311	55	77	104.5			64		107	2	2	1.53
N 311M	2311H	55	77	104.5			64		107	2	2	1.67
NU 311 M	32311H	55		98.5	70.5		64	111		2	2	1.71
NF 311	12311	55	77	99	104.5		64	111	107	2	2	1.54
NU 311 EPC/P5		55		100.6	70.5		64	111		2	2	1.44
NU 2311 M	32611H	55		98.5	70.5		64	111		2	2	2.77



single row

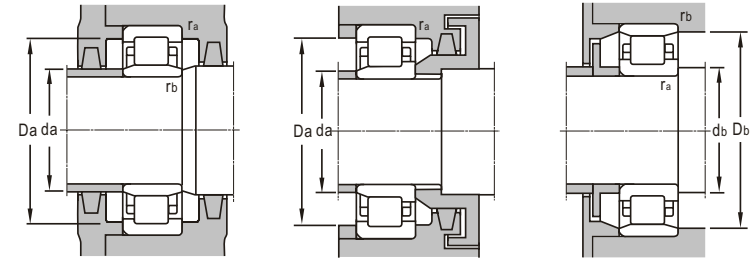
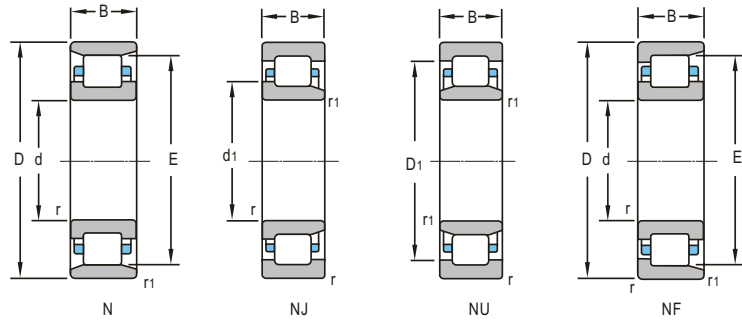

d 55~65mm

Boundary Dimensions					Basic Load Ratings		Limiting Speeds	
d	D	B	r _{min}	r _{1min}	Dynamic C	Static C ₀	Grease	Oil
mm					kN		r/min	
55	120	43	2	2	148	162	4800	5600
	120	43	2	2	202	235	4800	5600
	140	33	2.1	2.1	139	138	4800	5600
	140	33	2.1	2.1	139	138	4800	5600
60	95	18	1.1	1	48.7	62.3	6700	8000
	110	22	1.5	1.5	73.3	82	5300	6300
	110	22	1.5	1.5	98.5	108.6	5300	6300
	110	22	1.5	1.5	76	87	5300	6300
	110	22	1.5	1.5	76	87	5300	6300
	130	31	2.1	2.1	126	130	4300	5000
	130	31	2.1	2.1	135	140	4300	5000
	130	31	2.1	2.1	126	130	4300	5000
	130	31	2.1	2.1	126	130	4300	5000
	130	31	2.1	2.1	135	140	4300	5000
	130	31	2.1	2.1	126	130	4300	5000
	130	31	2.1	2.1	135	140	4300	5000
	130	31	2.1	2.1	155	164	4300	5000
	130	31	2.1	2.1	155	164	4300	5000
	130	46	2.1	2.1	222	262	4300	5000
	130	46	2.1	2.1	222	262	300	5000
	140	51	2.5	2.5	145	108	4300	5000
	150	35	2.1	2.1	167	168	4300	5000
	150	35	2.1	2.1	167	168	4300	5000
	150	35	2.1	2.1	206	220	4300	5000
65	100	18	1.1	1	41.0	51	6300	7500
	120	23	1.5	1.5	85	96.1	4800	5600
	120	23	1.5	1.5	85	96.1	4800	5600
	120	31	1.5	1.5	144	172	4800	5600
65	120	31	1.5	1.5	144	172	4800	5600
	140	33	2.1	2.1	140	146	4000	4800
	140	33	2.1	2.1	140	146	4000	4800
	140	33	2.1	2.1	140	146	4000	4800
	140	33	2.1	2.1	140	146	4000	4800
	140	33	2.1	2.1	140	146	4000	4800
	140	33	2.1	2.1	177	211	4000	4800
	140	33	2.1	2.1	177	211	4000	4800
	140	33	2.1	2.1	140	146	4000	4800
	140	33	2.1	2.1	140	146	4000	4800
	140	33	2.1	2.1	140	146	4000	4800

Bearing Designations		Journal	Other Dimensions				Mounting Dimensions					Mass	
Present	Original		d ₁	D ₁	E	F	d _{amin}	D _{amax}	d _{bmin}	r _{amax}	r _{max}		
		mm	mm					mm					kg
NJ 2311 M	42611 H	55	76	98.5	70.5		64	111	2	2		2.93	
NJ 2311EF1/C4YB		55	77.5	100	77.2		64	111	2	2		2.45	
NU 411M	32411H	55		108	77.2		66	129	2	2		3.24	
NJ 411M	42411 H	55	85	108	77.2		66	129	2	2		3.29	
NU1012 M		60		82.2	69.5		65	88.5	1	1		0.49	
N 212	2212	60	78.4		97.5		68	100	1.5	1.5		0.872	
NJ 212 E	42212E	60	77.6	95	72		68	102	1.5	1.5		0.705	
NU 212M	32212H	60		92.2	73.5		68	102	1.5	1.5		0.955	
NJ 212M	42212H	60	77.6	92.2	73.5		68	102	1.5	1.5		0.981	
N 312	2312	60	82.6		113		71		116	2	2	1.86	
N 312M	2312H	60	85.4		113		71		116	2	2	2.05	
NU 312	32312	60		106.5	77		71	120	2	2		1.86	
NU 312Q1	32312Q	60		106.5	77		71	120	2	2		2.08	
NU 312M	32312H	60		106.5	77		71	120	2	2		2.08	
NJ 312	42312	60	84.2	106.5	77		71	120	2	2		1.9	
NJ 312M	42312H	60	84.2	106.5	77		71	120	2	2		2.12	
NJ 312 EF1		60	84.3	109	77		71	120	2	2		1.95	
NU 312 EPC/P5		60		110	77		71	120	2	2		1.82	
N 2312EF1		60	84.3		115		71		116	2	2	2.9	
NJ2312EF1		60	84.3	108	77		71	120	2	2		2.99	
N 612/C9	2712 U	60	86		122		75		125	2	2	3.21	
N 412M	2412H	60	91.65		127		71		128	2	2	3.52	
NJ 412	42412	60	91	118.8	83		71	138	2	2		3.21	
NJ 412 EF1		60	91.5	121	83		72	138	2	2		3.14	
NU 1013M	32113H	65		86.6	74.5		70	93.5	1	1		0.522	
NJ 213 M		65	85	101.6	79.5		74	111	1.5	1.5		1.18	
N 213 M		65	85		105.5		74		108	1.5	1.5	1.15	
NU2213EM		65		104	78.5		74	111	1.5	1.5		1.63	
NU2213ENM		65		104	78.5		74	111	1.5	1.5		1.61	
N 313	2313	65	91		121.5		77		125	2	2	2.32	
N 313M	2313H	65	92.3		121.5		77		125	2	2	2.58	
NU 313M	32313H	65		114.9	83.5		77	129	2	2		2.51	
NU 313Q1	32313Q	65		114.9	83.5		77	129	2	2		2.53	
NJ 313M	42313H	65	91	114.9	83.5		77	129	2	2		2.57	
NJ 313 E		65	90.6	118.8	82.5		77	129	2	2		2.45	
NU 313 EF1		65		118.8	82.5		77	128	2	2		2.41	
N 313Q1/P6 S0		65	92.3		121.5		77		125	2	2	2.54	
NU 313Q1/P63 S0		65		114.9	83.5		77	129	2	2		2.53	
NJ 313Q1/P63 S0		65	90.5	114.9	83.5		77	129	2	2		2.6	



Cylindrical Roller Bearings

single row

LYC®

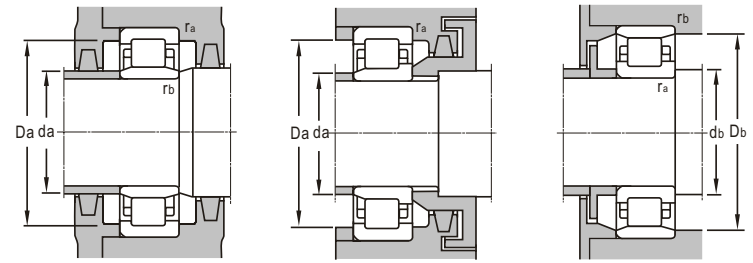
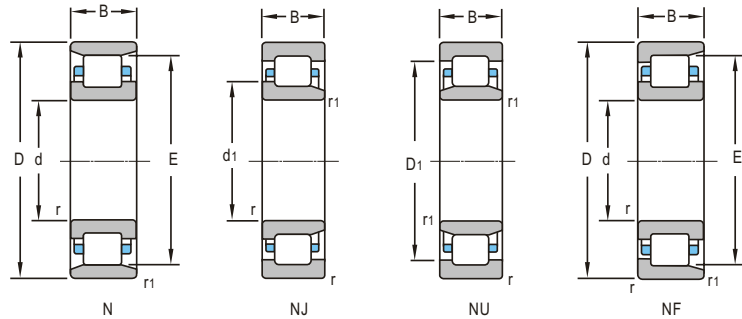

d 65~75mm

Boundary Dimensions					Basic Load Ratings		Limiting Speeds	
d	D	B	r _{min}	r _{1min}	Dynamic C	Static C ₀	Grease	Oil
mm					kN		r/min	
65	140	48	2.1	2.1	238	276	4000	4800
70	125	24	1.5	1.5	83.5	95.0	4500	5300
	125	24	1.5	1.5	83.5	95.0	4500	5300
	125	24	1.5	1.5	123	143	4500	5300
	125	24	1.5	1.5	112	126	4500	5300
	125	24	4	1.5	123	143	4500	5300
	125	24	1.5	1.5	123	143	4500	5300
	125	24	1.5	1.5	123	143	4500	5300
	125	31	1.5	1.5	145	185	4500	5300
	133	35	20.1		209	228		
	150	35	2.1	2.1	173	189	3600	4300
	150	35	2.1	2.1	173	189	3600	4300
	150	35	2.1	2.1	173	189	3600	4300
	150	35	2.1	2.1	173	189	3600	4300
	150	35	2.1	2.1	173	189	3600	4300
	150	35	2.1	2.1	209	228	3600	4300
	150	35	2.1	2.1	209	228	3600	4300
150	35	2.1	2.1	209	228	3600	4300	
150	51	2.1	2.1	274	322	3600	4300	
150	51	2.1	2.1	258	298	3600	4300	
180	42	3	3	250	266	3600	4300	
75	115	20	1.1	1	66.8	85.5	5600	6700
	130	25	1.5	1.5	123	146	4500	5300
	130	25	1.5	1.5	134	162	4500	5300
	160	37	2.1	2.1	190	205	3400	4000
	160	37	2.1	2.1	190	205	3400	4000
	160	37	2.1	2.1	190	205	3400	4000
	160	37	2.1	2.1	190	205	3400	4000
	160	37	2.1	2.1	190	205	3400	4000
	160	37	2.1	2.1	190	205	3400	4000
	160	37	2.1	2.1	217	236	3400	4000
	160	37	2.1	2.1	172	172	3400	4000
	160	37	2.1	2.1	217	236	3400	4000
	160	37	2.1	2.1	217	236	3400	4000
	160	37	2.1	2.1	217	236	3400	4000
	160	37	2.1	2.1	190	205	3400	4000
	160	37	2.1	2.1	182	200	3400	4000
	160	37	2.1	2.1	182	200	3400	4000
	190	45	3	3	301	329	3400	4000
	160	55	2.1	2.1	308	361	3400	4000

Bearing Designations		Journal	Other Dimensions				Mounting Dimensions					Mass	
Present	Original		d ₁	D ₁	E	F	d _{amin}	D _{amax}	d _{bmin}	r _{amax}	r _{0max}		
		mm	mm					mm					kg
NU 2313 EM	32613EH	65		119		82.5	77	129	2	2		3.71	
NJ 214M	42214H	70	88.6	105.1		84.5	78	117	1.5	1.5		1.36	
NU 214M	32214H	70		105.1		84.5	78	117				1.34	
N 214 EL	2214EL	70	89.6		114		78		114	1.5	1.5	1.21	
N 214 EM		70	89.6			83.5	78		114	1.5	1.5	1.33	
NF 214/C9YB2		70	89.6	109	114		78		114	3	1.5	1.25	
NJ 214 EF1		70	89.6	109		83.5	78	117		1.5	1.5	1.25	
NJ 214 EF1/YB2		70	89.6	109		83.5	78	117		1.5	1.5	1.25	
NJ2214EM	42514EH	70	89.4	10		83.5	78	117		1.5	1.5	1.93	
RN 214 EM/HE		70	98	9			80					2.16	
N 314	2314	70	97.8			130	81		134	2	2	2.73	
N 314 M	2314H	70	99.3			130	81		134	2	2	3.02	
NU 314M	32314H	70		120.5		90	81	139		2	2	3.09	
NU 314Q1	32314Q	70		120.5		90	81	139		2	2	3.12	
NJ 314M	42314H	70	98	120.5		90	81	139		2	2	3.18	
NJ 314Q1	42314Q	70	98	120.5		90	81	139	139	2	2	3.12	
NJ 314 EF1		70	97.5	126		89	81	139		2	2	2.97	
NU 314 EF1/C4YB		70		126		89	81	139		2	2	2.97	
NU 314 ENM		70		125		89	81	139		2	2	3.2	
NJ 2314 EF1		70	97.5	126		89	81	139		2	2	5.6	
NJ 2314 E		70	97.5	126		89	81	139		2	2	4.4	
N 414 M/YA1		70	110		152		81	167	2.5	2.5		6.1	
NU 1015M		75		100.6		85	80	108.5	1	1		0.728	
NJ215EQ1/P63SO		75	95	113		88.5	84	121	1.5	1.5		1.45	
N 215 EF1		75	94.6		118.5		84		120	1.5	1.5	1.8	
N315M	2315H	75	103.7		139.5		86		143	2	2	3.77	
N 315	2315	75	103.7		139.5		86		143	2	2	3.49	
NU315M	32315H	75		130.2		95.5	86	148		2	2	3.80	
NU315Q1	32315Q	75		130.2		95.5	86	148		2	2	3.68	
NU 315	32315	75		130.2		95.5	86	148		2	2	3.34	
N315EF1	2315EW1	75	104.2		143		86		143	2	2	3.56	
NJ 315	42315	75	102.2	130.2		95.5	86	148		2	2	3.959	
NU 315 E	32315E	75		136.5		95	86	148		2	2	3.71	
NU315EF1	32315EW1	75		136.5		95	86	148		2	2	3.71	
NJ 315 EF1	42315EW1	75	104.2	136.5		95	86	148		2	2	3.63	
NJ315M	42315H	75		130.2		95.5	86	148		2	2	3.96	
NJ315Q1/P63SO	3E42315QT	75	104.8	128.8		96.5	86	148		2	2	3.81	
NU315Q1/P63SO		75	102.2	128.8		96.5	86	148		2	2	3.76	
NJ 415 F1		75	116	149.8		104.5	88	177		2	2	8.73	
NU2315 EM	32615 EH	75		136		95	86	148		2	2	5.58	



Cylindrical Roller Bearings

single row

LYC®

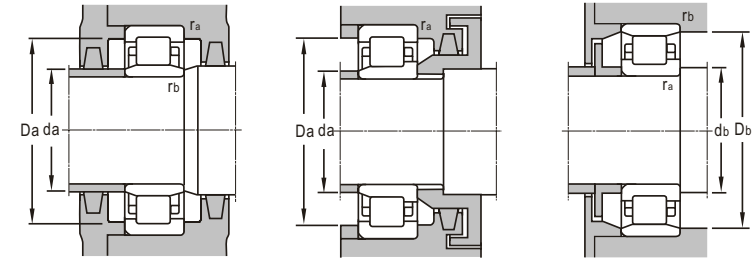
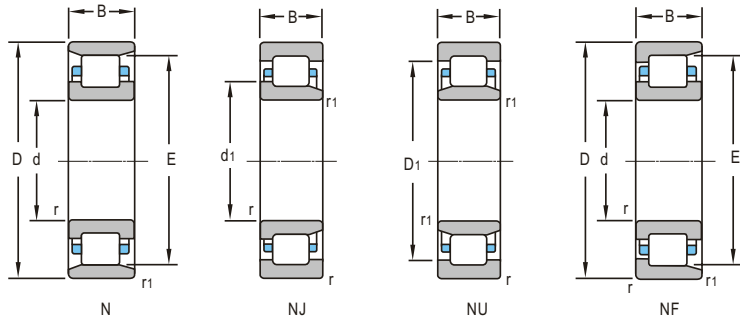

d 75~95mm

d	Boundary Dimensions				Basic Load Ratings		Limiting Speeds		
	D	B	r _{min}	r _{1min}	Dynamic C	Static C ₀	Grease	Oil	
mm									
75	160	55	2.1	2.1	308	361	3400	4000	
	160	68.3	2.1	2.1	321	306	2500	3000	
80	140	26	2	2	121	145	4000	4800	
	140	26	2	2	121	145	4000	4800	
	140	26	2	2	121	145	4000	4800	
	140	26	2	2	121	145	4000	4800	
	140	26	2	2	131	154	4000	4800	
	140	26	2	2	127	95.8	4000	4800	
	140	33	2	2	187	245	4000	4800	
	170	39	2.1	2.1	262	291	3200	3800	
	170	39	2.1	2.1	233	249	3200	3800	
	170	39	2.1	2.1	262	299	3200	3800	
	170	58	2.1	2.1	274	330	3200	3800	
	170	58	2.1	2.1	274	330	3200	3800	
85	130	22	1.1	1	74	108	5000	6000	
	180	41	3	3	242	273	3000	3600	
	180	41	3	3	242	273	3000	3600	
	180	41	3	3	242	273	3000	3600	
	180	41	3	3	298	339	3000	3600	
	180	41	3	3	250	270	3000	3600	
	180	60	3	3	315	380	3000	3600	
	180	60	3	3	380	475	3000	3600	
	180	60	3	3	315	380	3000	3600	
	180	60	3	3	380	475	3000	3600	
	180	60	3	3	380	475	3000	3600	
	90	160	30	2	2	163	195	3600	4300
160		30	2	2	163	195	3600	4300	
160		30	2	2	163	195	3600	4300	
190		43	3	3	261	297	2800	3400	
190		43	3	3	261	297	2800	3400	
190		43	3	3	322	362	2800	3400	
190		43	3	3	261	297	2800	3400	
190		43	3	3	355	362	2800	3400	
190		64	3	3	430	530	2800	3400	
190		64	3	3	430	530	2800	3400	
95		200	45	3	3	340	395	2600	3200
		200	45	3	3	340	395	2600	3200

Bearing Designations	Journal	Other Dimensions				Mounting Dimensions					Mass		
		Present	Original	d ₁	D ₁	E	F	d _{amin}	D _{amax}	d _{bmin}		r _{amax}	r _{max}
mm													
NJ 2315 EM	75			104	136	95		86	148	2	2	5.69	
NU 3315M	75	3032315H			130.2	95.5		86	148	2	2	7.39	
NJ 216	80	42216		101	118.3	95.3		89	131	2	2	1.63	
N 216M	80	2216H		102		125		89	131	2	2	1.72	
NU 216	80	32216			118.3	95.3		89	131	2	2	1.59	
NJ 216M	80	42216H		101	118.3	95.3		89	131	2	2	1.78	
NU 216 E	80	32216E			122	95.3		89	131	2	2	1.52	
NU 216 EF1	80	32216 EW1			118.3	95.3		89	131	128	2	2	1.64
NU 2216 EQ1/P63S0	80				122.5	95.3		89	131	2	2	2.32	
NU316EF1	80				144.2	101		91	159	2	2	4.23	
N316EM	80			110		151		91	151	2	2	4.34	
NU 316EM	80				144.2	101		91	159	2	2	4.35	
NU 2316L	80	32616L			139	103		91	159	2	2	6.10	
NJ 2316L	80	42616L		111	139	103		91	159	2	2	6.21	
NU1017 M1	85				114	96.5		90	123.5	1	1	1.06	
N317L	85	2317L		115.5	156			99	162	2.5	2.5	4.78	
N317L/YB2	85	2317L(Y)		115.5	156			103	162	2.5	2.5	4.7	
NJ317Q1/C63S0	85	3E42317QT		118	145.5	108.5		99	166	2.5	2.5	5.29	
N317EF1	85			117.4	160			98	162	2.5	2.5	6.51	
N 317 EM	85			117.5	160			98	162	2.5	2.5	5.02	
NU 2317M	85	32617H			147.3	108		108	108	108	108	8.00	
NU2317EM	85	32617EH			153	108		98	166	2.5	2.5	8.1	
NJ 2317M	85	42617H		114	147.3	108		98	166	2.5	2.5	8.58	
NU 2317 EF1	85	32617E			153	108		98	166	2.5	2.5	6.9	
NU 2317 EM/YA1	85	32617EHY			153	108		98	166	2.5	2.5	8.1	
N218M	90			113.6	143			100	150	2	2	2.55	
NU218M	90				134.5	107		100	150	150	2	2	2.62
NF 218M	90			113.6	136	143			150	2	2	2.42	
NU 318M	90	32318H			153.5	115		104	176	2.5	2.5	6.2	
NU 318Q1/P63S0	90	3E32318QT			153.5	115		104	176	2.5	2.5	6.2	
NU318EF1	90				161	113.5		104	176	2.5	2.5	7.7	
N 318	90	2318		125		165		104	169	2.5	2.5	5.46	
NU 318EM	90				159.3	113.5		104	176	2.5	2.5	8.87	
NU2318M	90				159.3	113.5		104	176	2.5	2.5	9.51	
NJ 2318 EM/C9S0	90			124.4	159.3	113.5		104	176	2.5	2.5	9.51	
N 319 EL	95	2319EL		132	177.5			108	178	2.5	2.5	6.44	
NU319EL1	95				170	121.5		108	186	2.5	2.5	6.52	



single row

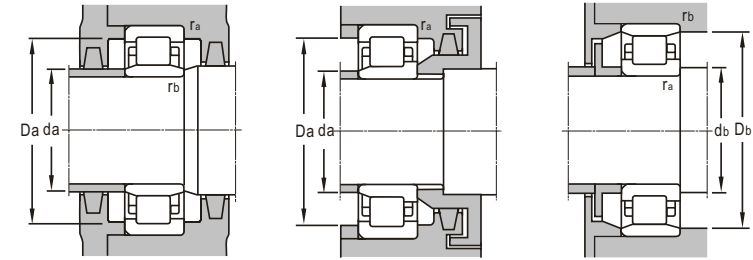
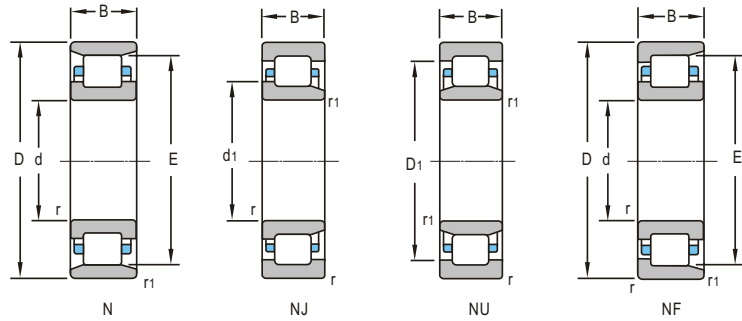

d 95~120mm

Boundary Dimensions					Basic Load Ratings		Limiting Speeds	
d	D	B	r _{min}	r _{1min}	Dynamic C	Static C ₀	Grease	Oil
mm					kN		r/min	
95	200	45	3	3	340	395	2600	3200
	200	45	3	3	340	395	2600	3200
	200	67	3	3	458	580	2600	3200
	200	67	3	3	433	538	2600	3200
	200	67	3	3	411	496		
	220	67	3	3	518	610	2400	3000
100	180	34	2.1	2.1	183	217	3200	3800
	180	34	2.1	2.1	227	270	3200	3800
	180	46	2.1	2.1	333	444	3200	3800
	180	46	2.1	2.1	335	445	3200	3800
	180	50	2.5	2.5	258	315	3200	3800
	215	47	3	3	390	440	2400	3000
	215	47	3	3	408	440	2400	3000
	215	73	3	3	524	505	2400	3000
	215	73	3	3	524	505	2400	3000
	215	73	3	3	524	505	2400	3000
	215	73	3	3	536	726	2400	3000
	215	73	3	3	536	726	2400	3000
	215	73	3	3	579	732	2400	3000
	105	160	26	2	1.1	105	142	4000
110	170	28	2	1.1	144	195	3800	4500
	200	38	2.1	2.1	266	323	2800	3400
	200	38	2.1	2.1	266	323	2800	3400
	200	38	2.1	2.1	266	323	2800	3400
	200	38	2.1	2.1	266	323	2800	3400
	200	69.85	2	4	402	655	2800	3400
	240	50	3	3	411	545	2000	2600
	240	50	3	3	411	545	2000	2600
	240	50	3	3	411	545	2000	2600
	240	50	3	3	411	545	2000	2600
	240	80	3	3	621	735	2000	2600
	240	80	3	3	621	735	2000	2600
	240	80	3	3	635	822	2000	2600
	260	92	3	3	796	971	1800	2400
280	65	4	4	555	631	2000	2600	
280	65	4	4	555	631	2000	2600	
120	215	40	2.1	2.1	282	355	2400	3000

Bearing Designations		Journal	Other Dimensions				Mounting Dimensions					Mass
Present	Original		d ₁	D ₁	E	F	d _{amin}	D _{amax}	d _{bmin}	r _{amax}	r _{0max}	
		mm	mm								kg	
N 319 EF1		95	132		177.5		108		178	2.5	2.5	8.69
NU 319 EF1		95		170		121.5	108	186		2.5	2.5	8.77
NJ 2319EF 1		95	131.5	168		121.5	108	187		2.5	2.5	13.1
NU 2319EM		95	131.5	168		121.5	108	187		2.5	2.5	10.2
NU 2319Q Y		95		164		121.5	108	187		2.5	2.5	10.5
NF 619	3-256	95	137.2	182	193		108	200		2.5	2.5	13.9
NJ 220M	42220H	100	128	151		120	111	169		2	2	3.98
N 220 EM		100	127		163		111		164	2	2	3.93
NU 2220 EM/P5		100		157		119	111	169		2	2	5
NU 2220 EM		100	127	157		119	111	169		2	2	4.9
NJ 2220 X2M	42720H	100	127.9	151		120	111	169		2	2	5.91
N320 EF1		100	139		191.5		114	202		2.5	2.5	8.08
NJ 320 EM		100	139	182		128	114	202		2.5	2.5	8.67
N 2320 EM	2620EH	100	139		191.5		114	202		2.5	2.5	14.4
NU 2320 EM	32620EH	100		182		127.5	114	202		2.5	2.5	14.3
NU 2320 EM/YA1	32620HY	100		182		127.5	114	202		2.5	2.5	14.3
NJ 2320EQ 1/P63S 0	3E42620EQT	100	140	182		127.5	114	202		2.5	2.5	13.3
NJ 2320EM /C9S 0		100	140	182		127.5	114	202		2.5	2.5	14.3
NJ 2320 ZEM		100	139	182		127.5	114	201		2.5	2.5	14.4
NF1021M	12121H	105	124.7	141	145.5			151		2	1	1.99
NU1022 M		110		149		125	116.5	161		2	1	2.34
NJ 222 EM		110	141.3	174		132.5	122	188		2	2	5.26
NU 222 EM		110		174		132.5	122	188		2	2	5.19
N222 EM		110	141.3		180.5		122		182	2	2	5.33
NU 222EQ 1/P53 SO		110		174		132.5	122	188		2	2	5.41
LY-N006		110		171		133	122	188		2	3	9
N 322 E	2322EL	110	155	198	211		124		215	2.5	2.5	10.5
NJ32 2EQ		110	154.5	198		143	124	226		2.5	2.5	12.7
N322 EM		110	154.4	198	207		124		211	2.5	2.5	12.1
NJ32 2EM		110	154.5	198		143	124	226		2.5	2.5	12.9
NU 2322 EM	32622EH	110		201		143	124	226		2.5	2.5	19.9
NJ 2322 EM/YA1	32622EAY	110		201		143	124	226		2.5	2.5	19.9
NU 2322EQ 1/P63S 0		110		201		143	124	226		2.5	2.5	19.1
NF 622	3-257	110	161.4	214	227			226		2.5	2.5	27.4
NJ 422M		110	169.5	223		155	126	264		3	3	22
NJ 422Q 1/C350		110	169.5	223		155	126	264		3	3	22
NU 224EQ 1	3D3224EQT	120		184		143.5	131	204		2	2	7.07



single row

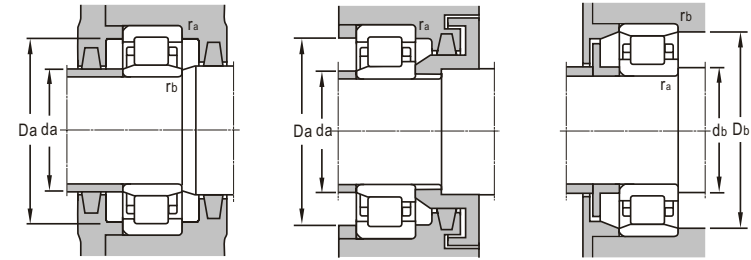
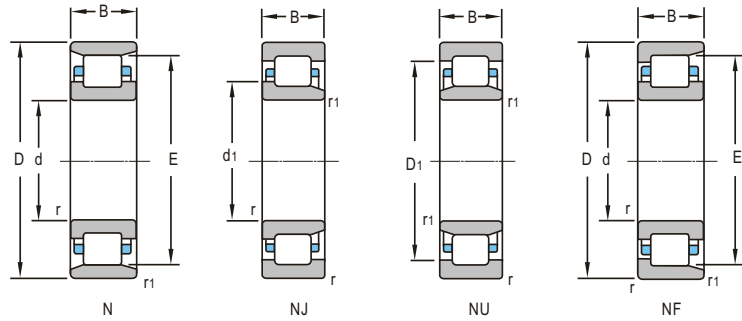

d 120~140mm

Boundary Dimensions					Basic Load Ratings		Limiting Speeds	
d	D	B	r _{min}	r _{1min}	Dynamic C	Static C ₀	Grease	Oil
mm					kN		r/min	
120	215	40	2.1	2.1	300	420	2400	3000
	215	40	2.1	2.1	300	420	2400	3000
	215	40	2.1	2.1	300	420	2400	3000
	215	40	2.1	2.1	342	433	2400	3000
	215	58	2.1	2.1	380	520	2400	3000
	217	58	2.1	2.1	380	520	2400	3000
	240	80	3	3	477	408	2400	3200
	240	80	3	3	477	408	2400	3200
	240	80	3	3	477	408	2400	3200
	260	55	3	3	537	623	1900	2400
	260	55	3	3	537	623	1900	2400
	260	86	3	3	285	1020	1900	2400
	260	86	3	3	285	1020	1900	2400
	260	86	3	3	785	1020	1900	2400
	260	86	3	3	915	1040	2800	4300
	130	200	33	2	1.1	213	315	3200
200		33	2	1.1	172	238	3200	3800
200		33	2	1.1	172	238	3200	3800
230		40	3	3	371	466	2200	2800
230		40	3	3	288	372	2200	2800
250		80	3	3	604	807	2200	3000
250		80	3	3	604	807	2200	3000
250		80	3	3	604	807	2200	3000
250		80	3	3	604	807	2200	3000
280		58	4	4	590	694	1800	2200
280		58	4	4	590	694	1800	2200
280		93	4	4	920	1230	1800	2200
280		93	4	4	920	1230	1800	2200
280		93	4	4	1060	1250	2400	3800
340		78	5	5	825	955	1500	1900
340		78	5	5	825	955	1500	1900
340	78	5	5	825	955	1500	1900	
140	210	33	2	1.1	212	317	3000	3600
	210	33	2	1.1	212	317	3000	3600
	250	42	3	3	406	536	2000	2600
	250	42	3	3	406	536	2000	2600
	250	42	3	3	389	507	2000	2600
	250	42	3	3	389	507	2000	2600
250	42	3	3	406	556	2000	2600	

Bearing Designations		Journal	Other Dimensions				Mounting Dimensions					Mass	
Present	Original		d ₁	D ₁	E	F	d _{amin}	D _{amax}	d _{bmin}	r _{amax}	r _{max}		
		mm	mm					mm					kg
N 224M	2224H	120	153.1	188	191.5		131		196	2	2	6.19	
NU 224M	32224H	120		182.3		143.5	131	204		2	2	6.47	
NJ 224M	42224H	120	151.5	182.3		143.5	131	204		2	2	6.48	
NJ 224EM		120	152.3	188		143.5	140	204		2	2	6.5	
N 2224M		120	152.3		191.5		140		204	2	2	9.4	
N 2224 MX1/CN2		120	152.3	188	195.5		140		206	2	2	9.7	
NJ 3224X3Q1/S0	42724QT	120	162	194		150	134	226		3	3	17.1	
NJ 3224X3M	42724QT	120	162	194		150	134	226		2.5	2.5	17.8	
NJ3224X3Q1	42724H	120	161	199		150	134	226		3	3	17.7	
N324EM		120	167.5		230		134		230	2.5	2.5	14.4	
NU324EM		120		219		154	134	246		2.5	2.5	14.5	
NU 2324 EM	32624EH	120		219		154	134	246		2.5	2.5	23.8	
NU2324EM/YA1	32624EHY	120		219		154	134	246		2.5	2.5	23.8	
NJ 2324EM/C9S0		120	168	216		154	134	246		2.5	2.5	23.6	
NJ 2324 ZEM		120	168	219		154	134	246		2.5	2.5	23.6	
N1026 M	32126Q	130	154	148	182		137	191	190	2	1	3.48	
NU 1026Q1	32126Q	130		174		148	136.5	191		2	1	3.83	
NU 1026M	32126H	130		174		148	136.5	191		2	1	3.84	
NU 226 EM		130		201.5		153.5	144	216		2.5	2.5	7.11	
NU 226 Q1/P53 SO		130		193.4		156	144	216		2.5	2.5	7.12	
NJ 3226x1M	42726H	130	170	208		158	144	236		2.5	2.5	18.7	
NJ 3226x1Q1/S0	42726QT	130	170.5	205		158	144	236		3	3	18.7	
NJP3226X1		130	171	205.6		158	144	236		3	3	18.5	
NJ3226X1		130	171	205.6		158	144	236		3	2.5	18.3	
N 326EM		130	181.5		247		148		247	3	3	18.2	
NU 326EM		130		235.5		167	148	262		3	3	18.3	
NU2326EM		130		236		167	148	262		3	3	28.8	
NJ 2326EM		130	181	236		167	148	262		3	3	29.5	
NJ 2326 ZEM		130	181	236		167	147	263		3	3	30.5	
NU 426M	32426H	130		265		183	150	320		4	4	41.5	
NJ 426M	42426H	130	203	265		183	150	320		4	4	41.7	
NU426Q1	32426Q	130	203	262		185	150	320		4	4	39.2	
NU 1028 M		140		184.5		158	146.5	201		2	1	4.03	
NU 1028Q1/P64		140		184.5		158	146.5	201		2	1	4.03	
NJ 228 EF1		140	179.5	217		169	154	236		2.5	2.5	11.6	
NU 228 EF1		140		217		169	154	236		2.5	2.5	10.9	
NJ 228 EM		140	179.5	217		169	154	236		2.5	2.5	9.35	
NU 228 EM		140		217		169	154	236		2.5	2.5	8.72	
NU 228 EL	32228 EL	140		217		169	154	236		2.5	2.5	8.97	

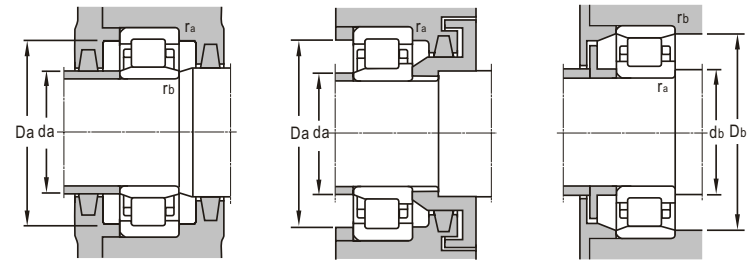
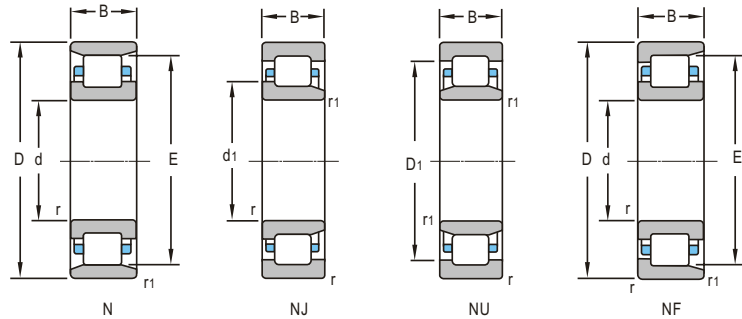

d 140~180mm

Boundary Dimensions					Basic Load Ratings		Limiting Speeds		
d	D	B	r _{min}	r _{1min}	Dynamic C	Static C ₀	Grease	Oil	
mm					kN		r/min		
140	250	68	3	3	547	787	2000	2600	
	250	68	3	3	547	787	2000	2600	
	250	68	3	3	547	787	2000	2600	
	250	68	3	3	577	843	2000	2600	
	250	82.55	3	3	661	1060	2000	2600	
	300	62	4	4	624	758	1980	2490	
	300	62	4	4	624	758	1800	2200	
	300	62	4	4	624	758	1800	2200	
	300	102	4	4	959	1320	1800	2200	
	300	102	4	4	959	1320	1800	2200	
150	270	45	3	3	419	543	1900	2400	
	270	45	3	3	419	543	1900	2400	
	270	45	3	3	419	543	2090	2640	
	320	65	4	4	720	970	1820	2300	
	320	65	4	4	720	970	1820	2300	
	320	108	4	4	1092	1472	1700	2000	
	160	290	48	3	3	493	665	1900	2300
		290	48	3	3	443	655	1800	2200
290		48	3	3	493	655	1800	2200	
290		48	3	3	493	655	2200	2600	
290		80	3	3	771	1118	1800	2200	
340		68	4	4	873	1080	1500	1800	
340		114	4	4	1138	1800	1500	1800	
170		260	42	2.1	2.1	260	380	2200	2800
	310	52	4	4	530	747	1900	2300	
	310	52	4	4	589	776	1800	2200	
	310	52	4	4	589	776	1800	2200	
	310	86	4	4	914	1315	1800	2200	
	360	72	4	4	892	1090	1400	1700	
	360	120	4	4	1154	1622	1400	1700	
	360	120	4	4	1154	1622	1400	1700	
	180	280	82.6	2.1	2.1	817	1290	2000	2600
		280	31	2	2	270	423	2000	2600
320		52	4	4	587	782	1700	2000	

Bearing Designations		Journal	Other Dimensions				Mounting Dimensions					Mass
Present	Original		d ₁	D ₁	E	F	d _{amin}	D _{amax}	d _{bmin}	r _{amax}	r _{0max}	
		mm	mm								kg	
NJ 2228 EM	42528EH	140	179	217	169	154	236	2.5	2.5	17		
	NJ 2228Q1/C4S 0	140	179	217	169	154	236	2.5	2.5	15.5		
	NU 2228 Q1/C4S0	140		217	169	154	236	2.5	2.5	15.1		
	NU 2228EM/P5	140		217	169	154	236	2.5	2.5	14.4		
	NU 3228X2M	140		213	169	154	236	2.5	2.5	18.4		
	NJ 328Q1/P64S0	4E42328EQTY	140	194	248.5	180	158	282	3	3	21.5	
	NU 328Q1/P63S0	3E32328EQT	140		248.5	180	158	282	3	3	21.6	
	N 328 EM		140	194		260	156		265	3	3	21.7
	NJ 2328EM		140	194	248.5	180	158	282	3	3	37.3	
	NU 2328EM		140		248.5	180	158	282	3	3	36.7	
	NF3328X2	3-254	140	190.4	253.4	266	156		278	3	3	43.3
	NU428M	32428H	140		279	196	160	340	4	4	48	
	NJ428M	42428H	140	217	279	196	160	340	4	4	48.7	
	NJ 230EM		150	193.5	233	182	164	256	2.5	2.5	11.7	
		NU230EM	150		233	182	164	256	2.5	2.5	11.4	
		NU230EQ1/P63S0	3E32230EQT	150		233	182	164	256	2.5	2.5	10.4
NJ330Q1/P64S0		4E42330EQTY	150	209	270	193	166	304	3	3	25.7	
NU330Q1/P63S0		3E32330EQT	150		270	193	166	304	3	3	26.6	
NU 2330 EM		32630EH	150		270	193	166	304	3	3	45.7	
NU 232EQ1/P63S0		3E32232EQT	160		250	195	174	276	2.5	2.5	14.6	
		NU232EM	160		250	195	174	276	2.5	2.5	14.7	
	NJ 232 EM	160	206.5	250	195	174	276	2.5	2.5	14.9		
	N 232EM		160		250	195	174	276	2.5	2.5	14.6	
	NU 2232 EM	32532EH	160		245	193	174	276	2.5	2.5	24.5	
	NU 332 EQ1/P64S0	4E32332EQT	160		285	204	178	322	3	3	31.1	
NU2332E.M1		160		284.6	204	178	322	3	3	52		
NU 1034M	32134H	170		227	193	181	249	2	2	8.31		
	NJ 234Q1/P63S0	3E32234QT	170		263	208	188	292	3	3	17.8	
	NJ234M		170	220	268.5	207	188	292	3	3	17.9	
	NU234M		170		268.5	207	188	292	3	3	17.7	
	NU 2234 EM	32534EH	170		270	205	188	292	3	3	30	
	NU334EM		170		300.6	218	188	344	3	3	36.3	
	NU 2334M	32634H	170		289	220	188	344	3	3	62.3	
	NJ 2334M	42634H	170	237	289	220	188	344	3	3	63.6	
	NU 3036X2M	32836H	180		246	204	191	269	3	3	19.6	
		N 036M	180	219		250	191		257	2	2	7.97
NU 236 M		180		278.5	217	198	302	3	3	18.6		



single row

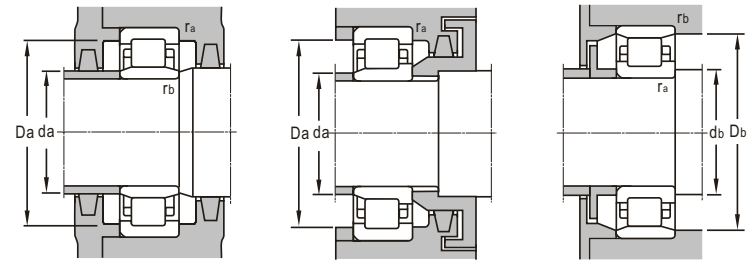
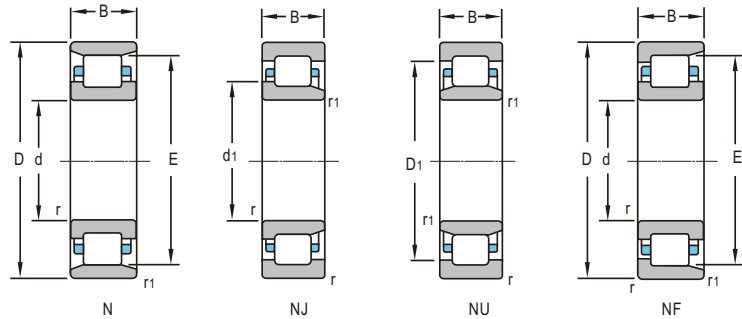

d 180~240mm

Boundary Dimensions					Basic Load Ratings		Limiting Speeds	
d	D	B	r _{min}	r _{1min}	Dynamic C	Static C ₀	Grease	Oil
mm					kN		r/min	
180	320	52	4	4	587	782	1700	2000
	320	86	4	4	954	1408	1700	2000
	380	126	4	4	1554	2212	1300	1600
	380	126	4	4	1860	2610	1600	2800
	380	252	4	4	3190	5220	1300	1600
190	260	42	2	2	239	216	2000	2800
	290	46	2.1	2.1	384	575	2000	2600
	340	55	4	4	649	871	1600	1900
	340	92	3	3	1220	1600	1600	1900
	200	310	34	2	2	280	300	1900
310		34	2	2	280	300	1900	2400
310		51	2.1	2.1	388	580	1900	2400
310		51	2.1	2.1	388	580	1900	2400
310		51	2.1	2.1	448	695	1900	2400
310		51	2.1	2.1	450	700	3000	3400
320		88.9	2.5	2.5	946	1346	1800	2300
340		50	4	4	421	603	1700	2200
360		58	4	4	745	1020	1500	1800
360		58	4	4	745	1020	1500	1800
220		340	56	3	3	470	750	1800
	340	56	3	3	470	750	1800	2200
	350	98.42	3	3	1150	1792	1600	2000
	400	65	4	4	769	1100	1500	1800
	400	65	4	4	769	1100	1500	1800
	460	88	5	5	1130	1020	1200	1500
230	370	80	4	4	844	1371	1400	1800
	370	80	4	4	844	1371	1400	1800
240	360	37	2.1	2.1	388	392	1700	2000
	360	56	3	3	497	820	1700	2000
	360	56	3	3	530	850	1700	2000
	360	56	3	3	497	820	1700	2000
	360	92	3	3	855	938	1600	1900
	390	108	4	4	1370	2310	1500	1800
	440	72	4	4	997	1450	1300	1600
	440	72	4	4	997	1450	1300	1600
	440	72	4	4	997	1450	1300	1600
	500	95	5	5	1390	1610	1000	1300

Bearing Designations		Journal	Other Dimensions				Mounting Dimensions					Mass	
Present	Original		d ₁	D ₁	E	F	d _{amin}	D _{amax}	d _{bmin}	r _{amax}	r _{0max}		
		mm	mm					mm					kg
NJ 236 M		180	230	278.5	217		198	302	3	3		18.9	
NU 2236 EM	32536EH	180	280	215		198	302	3	3		30.8		
NJ 2336 EM	42636EH	180	246	320	231		198	362	3	3		77.9	
FD-NUP2336VH		180	245	315	211.69		200	360	3	3		69.9	
FD-NJ2336VH-DF		180	245	315	211.71		200	360	3	3		137	
NU 2938Q1	2032938Q	190		235	207		201	249	2	2		6.45	
NU 1038 M		190		254	215		201	279	2	2		10.8	
NJ 238 EM		190	244	295.2	230		206	324	3	3		22.4	
NU 2238MA		190		297	206		210	324	2	2		39	
N040H	7002140W	200	243		277		211		283	2	2	10.2	
NFP 040H	7022140W	200	243	269	277		211	299	2	2		10.5	
NU 1040	32140	200		269		229	211	299	2	2		14.3	
NU 1040 NQ1	232140Q	200		269		229	211	299	2	2		14.3	
NJ 1040M		200	239	269		224	211	249	2	2		14.9	
N 1040M		200	242		282		211	299	284	2	2	14.3	
NU 640M	32840H	200		286.3		228	212	308		3		26.5	
N 640M	2740H	200	250		303		218		322	3	3	18.6	
NJ 240 EM		200	258	310		243	218	342		3	3	27.8	
NU 240 EM		200		310		243	218	342		3		27.3	
NU 1044	32144	220		297		250	233	327		2.5	2.5	19.3	
NU 1044 NQ	232144Q	220		297		250	233	327		2.5	2.5	18.9	
NU 644M	32844H	220		313		245	234	336		2.5	3	37.5	
NJ 244M		220	286	336.6		270	236	384		3	3	39.2	
NU 244M		220		336.6		270	236	384		3	4	38.4	
NU 344M	32344H	220		370.2		284	240	438		4		75.6	
N 646	2746H	230				334	246	354		3		37	
N 048F1	7002148W	240	287		325		251		348	2	2	14.7	
NU 1048M	32148H	240		318		270	253	347		2.5	2.5	20.4	
NU 1048Q	32148Q	240		318		270	253	347		2.5	2.5	20.4	
NJ 1048M	42148H	240	279	318		270	253	347		2.5	2.5	20.8	
NU3048EM	3032148EH	240		316.2		270	253	347		2.5	3	35.5	
NU 2148X3M/C9		240		340		275	258	372		3	3	53.7	
NU248		240		367.3		295	258	372		3	3	50	
NJ 248		240	313	367.3		295	258	422		3	4	50.7	
NU 348M	32348H	240		402.7		310	262	478		4		97.7	

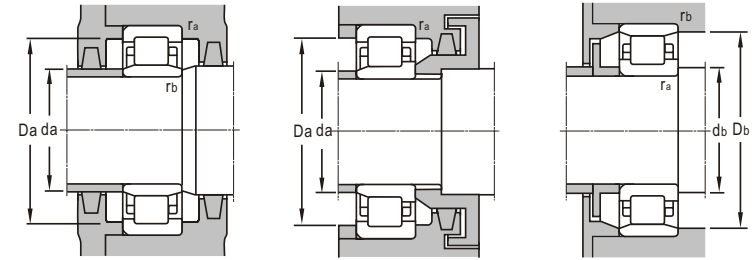
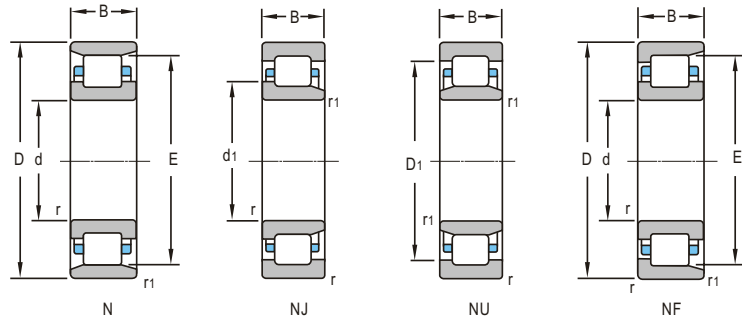

d 250~380mm

Boundary Dimensions					Basic Load Ratings		Limiting Speeds	
d	D	B	r _{min}	r _{1min}	Dynamic C	Static C ₀	Grease	Oil
mm					kN		r/min	
250	380	50	5	2.1	660	643	1300	1700
260	400	44	3	3	552	603	1500	1800
	400	65	4	4	659	1030	1500	1800
	400	65	4	4	659	1030	1500	1800
	400	65	4	4	659	1030	1500	1800
	400	65	4	4	659	1030	1500	1800
	400	65	4	4	659	1030	1500	1800
	480	80	5	5	1170	1700	1200	1500
280	420	65	4	4	693	1120		
	420	65	4	4	693	1120	1400	1700
	580	108	6	6	1642	2523	850	1000
300	460	74	4	4	1000	1660	1200	1500
	460	74	4	4	1000	1660	1200	1500
	460	74	3	3	885	1400	1300	1500
	460	74	4	4	893	1420	1200	1500
	460	118	4	4	1650	3050	1000	1300
	540	85	5	5	1420	2100	1000	1300
305	460	65	4	4	800	878	1200	1500
	460	65	4	4	800	878	1200	1500
320	480	74	4	4	1021	1727	1100	1400
	480	74	4	4	941	1549	1100	1400
	480	74	4	4	1021	1727	1100	1400
	480	74	4	4	941	1549	1100	1400
	670	200	7.5	7.5	3810	5700		
340	520	57	4	4	1035	1800	1000	1300
	520	57	4	4	957	1420	1000	1300
	530	133	5	5	1660	3320	900	1100
360	650	170	6	6	3000	5080	800	950
	750	224	7.5	7.5	5200	8300	630	750
368.1	558.8	114	5	5			900	1100
380	480	60	2.1	2.1	668	1437	1000	1300
	680	240	6	6	5450	10000	850	1300

Bearing Designations		Journal	Other Dimensions				Mounting Dimensions					Mass
Present	Original		d ₁	D ₁	E	F	d _{amin}	D _{amax}	d _{bmin}	r _{amax}	r _{0max}	
		mm	mm									kg
N 650L	2750L	250	298		347		272	368	4	2		19.8
N 052F1	7002152W	260	314		360		274	367	2.5	2.5		22.7
N 1052F1	2152W	260	312		364		276	367	3	3		30.8
NUP 1052F1		260		348		296	276	384	3	3		32.3
NU 1052F2		260		348		296	276	384	3	3		30.5
NU 1052F1		260		348		296	276	384	3	3		30.5
NU 1052M		260		348		296	276	384	3	3		31.4
Nu252 EMA		260		397		320	280	460	4	4		67.6
NJ 1056M		280	329	368		396	298	404	3	3		34.5
NU 1056M	32156H	280		368		316	298	404	3	3		33.4
NU 356M		280		469		362	308	552	5	5		139
NU 1060	32160	300		407		340	318	442	3	3		44.4
N 1060		300	353	407	420		318	442	3	3		44
NU 1060MA		300		402		340	316	444	2	2		44
NJ 1060M		300	356	407		340	318	442	3	3		44.3
NU 3060	3032160	300		407		340	316	442	3	3		72
NU 260	32260	300		450		365	322	520	4	4		87.2
N 661L	2761L	305	362		420.5		325	423	2.5	2.5		35.2
N 661	3-208	305	362		420.5		325	423	2.5	2.5		39.7
NU 1064	32164	320		427		360	338	462	3	3		47
NU 1064M		320		423		360	338	462	3	3		46.6
NU 1064 K	332164	320		427		360	338	462	3	3		46.1
NJ 1064M		320	376	423		360	338	462	3	3		47.7
NU 2364M		320		556		410	348	642	6	6		368
N 068	7002168	340	408		470		358	483	4	3		45.5
NJ 068 M		340	405	459		390	358	500	4	3		46.8
N 668 M	2768H	340	405		476		362	490	4	4		117
NU2272EM	32572EH	360		542		437	386	624	5	5		263
NU 2372	32672	360		610		455	395	715	6	6		485
N6/368.3	3-245	368.1	437		510		386	530	4	4		101
N 2876	2002876K	380	417		455		392	468	2	2		24.6
NU 3276/HCC 3 YA		380		581		451	410	650	5	5		384

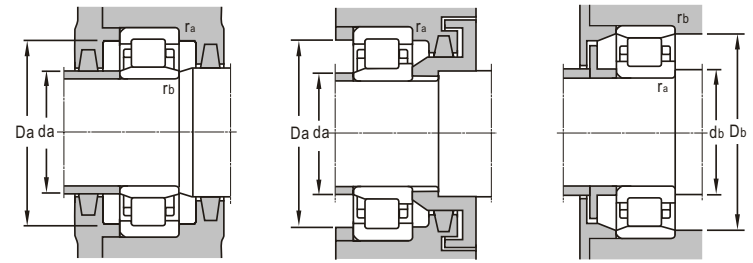
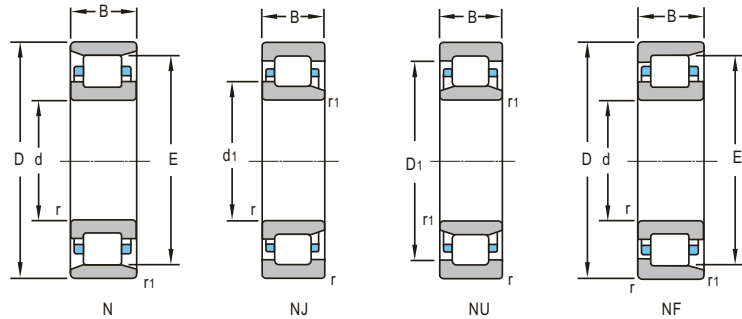

d 400~530mm

Boundary Dimensions					Basic Load Ratings		Limiting Speeds		
d	D	B	r _{min}	r _{1min}	Dynamic C	Static C ₀	Grease	Oil	
mm					kN		r/min		
400	540	65	4	4	965	1831	950	1150	
	600	90	5	5	1627	2806	900	1100	
	600	90	5	5	1627	1627	900	1100	
	600	148	5	5	2530	4950	800	980	
	650	145	6	6	2907	5429	750	900	
420	560	65	4	4	825	1650	900	1100	
	560	82	4	4	1440	3240	400	480	
	560	82	4	4	1240	2660	850	1100	
	700	224	6	6	5260	9730	630	800	
434	540	46	2.5	1.5	423	918	900	1100	
440	546	46	2.5	1.5	423	918	850	1000	
	720	122	6	6	2423	4052	800	950	
460	620	95	4	4	1769	3883	750	900	
	620	95	4	4	1700	3380	750	900	
	620	95	4	4	1769	3883	750	900	
	620	95	4	4	1870	4180	350	450	
	680	100	6	6	2000	3700	800	950	
	760	240	7.5	7.5	5600	10500	560	670	
	760	240	7.5	7.5	5880	11200	560	670	
	820	200	7.5	7.5	4900	8510	510	610	
	470	870	210	7.5	7.5	5100	8720	530	630
		870	210	7.5	7.5	5100	8720	530	630
480	650	78	5	5	1136	2213	850	950	
	790	248	7.5	7.5	6230	12100	530	630	
500	620	56	3	3	847	1790	800	950	
	670	100	5	5	2000	4510	750	900	
	720	100	6	6	2300	4510	750	900	
	720	6	6	6	9270	27100	900	1200	
	830	264	7.5	7.5	7100	13500	500	600	
	900	210	7.5	7.5	6590	11500	440	550	
	900	210	7.5	4.5	6590	11500	670	950	
530	650	72	3	3	1190	2820	750	900	
	710	106	4.5	4.5	2170	5200	700	850	
	870	272	7.5	7.5	7690	15100	440	550	

Bearing Designations		Journal	Other Dimensions				Mounting Dimensions					Mass
Present	Original		d ₁	D ₁	E	F	d _{amin}	D _{amax}	d _{bmin}	r _{amax}	r _{0max}	
		mm	mm									kg
NU 1980	1032980	400		490	434		418	522	3	3		42.7
NU 1080	32180	400		528	448		420	580	4	4		88.8
NU 1080K	332180	400		528	448		420	580	4	4		88.8
NU 3080	3032180	400		528	448		420	580	4	4		145
N 2180	2002780	400	492		585		428		612	5	5	190
NF1984/C9YA1		420	470.8	509.2	522		438	542	3	3		41.6
NCF 2984V		420	469	509	524		438	542	3	3		52.5
NU 2984M		470		727		575	490	850	6	6		595
NU 3184		420		613		485	444	676	5	5		348
NU 16/434	32987	434		502		468	445	525	2	1.5		26.2
NU 188X1	32788	440		502		468	454	534	2	1.5		26.5
N 1188	1002788	440	543		648		466		680	5	5	191
N 2992	2002992	460	516		580		480		588	3	3	82.4
NJ 2992EM		460	510	570		495	479	601	3	3		85.1
NU 2992	2032992	460		562		500	480	596	3	3		84
NCF 2992V		460	516	562	580		480	596	3	3		82.3
NU 1092M		460		600		516	484	656	5	5		130
NU 3192MA/4HC		460		662		529	489	731	6	6		647
NU 3192		460		659		529.3	496	724	6	6		435
NU 692/HC YA		460		697		550	489	791	6	6		465
NU 694M		470		727		575	490	850	6	6		595
NU1996-2		480		592		525	500	6300	4	4		76
NU 3196		480		701		556	516	754	6	6		489
NF 18/500EM		500	542	584	530		514	606	2	2		37.1
NU 29/500	20329/500	500		610		543	522	648	4	4		99.5
NU 10/500		500		648		556	528	692	5	5		135
500RV7211		500		648		560	525	700	6	6		730
NU 31/500		500		728		576	536	794	6	6		563
NU 6/500/HC		500		767		599	529	871	6	6		603
NU 6/500/HCC 3 YA		500		767		599	520	880	6	6		603
NU 28/530 EMA		530		614		561	544	636	2.1	2.1		52
NU 29/530	20329/530	530		644		575	555	685	4	4		123
NU 31/530/HC		530		764		612	559	841	6	6		649

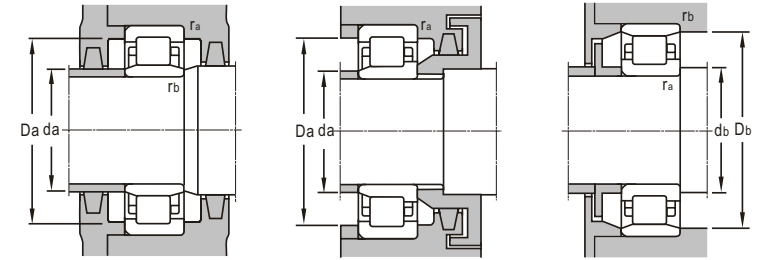
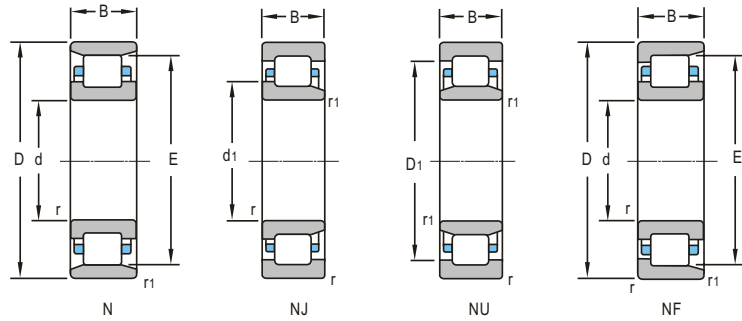

d 560~1250mm

Boundary Dimensions					Basic Load Ratings		Limiting Speeds	
d	D	B	r _{min}	r _{1min}	Dynamic C	Static C ₀	Grease	Oil
mm					kN		r/min	
560	680	56	3	3	908	2130	700	850
	680	72	3	3	1100	2720	680	820
	920	128	7.5	7.5	3540	6370	500	600
	920	128	7.5	7.5	3540	6370	900	1000
	920	128	6	6	3710	6210	900	1000
	920	128	7.5	7.5	3630	5820	900	1000
600	1090	155	9.5	9.5	4930	8390	480	850
630	850	100	6	6	2230	4633	600	700
	850	128	6	6	3158	7244	600	700
666.75	838.2	114.3	4	4	2890	6860	560	670
670	820	69	4	4	1208	2870	560	670
	820	112	4	4	2500	6760	560	670
	900	103	6	6	2640	5860	530	630
700	930	160	6	6	3450	8400	500	600
710	870	74	4	4	1370	3180	520	620
	950	106	6	6	2610	5530	500	600
	950	106	6	6	2610	5530	500	600
750	920	120	5	5	2530	6870	500	600
800	980	82	5	5	1804	4320	450	530
840	1040	125	4	4	3315	9729	430	500
950	1250	224	7.5	7.5	6549	17838	340	400
	1250	175	7.5	7.5	5317	13932	340	400
1060	1400	150	7.5	7.5	5768	15570	280	340
1120	1360	106	6	6	3430	8660	121	151
	1360	112	6	6	3720	10100	220	280
	1360	112	6	6	3720	10100		
1200	1520	185	7.5	7.5	5277	10223	200	260
1250	1630	170	7.5	7.5	5830	14000	195	250

Bearing Designations		Journal	Other Dimensions				Mounting Dimensions					Mass	
Present	Original		d ₁	D ₁	E	F	d _{amin}	D _{amax}	d _{bmin}	r _{amax}	r _{0max}		
		mm	mm					mm					kg
N 18/560		560	601		650		574		650	2.5	2.5	43.3	
NF 28/560M		560	601	640	650		574	666	650	2.5	2.5	55.8	
NU 1/560		560		797		660	596	884		6	6	381	
NU1/560X2+HJ1/560X		560		797		660	580	900		6	9	381	
NU 1/560+HJ1/560		560		797		660	580	900		6	6	381	
NU1/560+HJ1/560X		560		807		653	580	900		3	3	373	
NU2/600X+HJ2/600X		600		916		748	620	1070		8	8	727	
N 19/630		630	710		795		658		822	5	5	160	
NU 29/630	10029/630 20329/630	630		770		685	658	822		5	5	206	
NFP6/666.75Q1/C9	3-235U	666.75	724	785	803.3		685	820		3	3	146	
NJ 18/670M		670	726	769.5		712	688	802		3	3	78.9	
NJ 38/670Q1		670	718	774		706	688	802		3	3	123	
NU 19/670		670		825.5		731	698	872		5	5	188	
NU 6/700	327/700	700		845		760	728	902		5	5	295	
N 18/710/H/C/P6		710	765		830		726		845	3	3	95.2	
N 19/710		710	797		890		738		912	5	5	205	
NU 19/710	10029/710 10329/710	710		863		770	738	922		5	5	207	
N 38/750X2M		750	809		878		772		890	4	4	178	
NJ 18/800M		800	868	921		849	822	958		4	4	120	
N 6/840	27/840	840	912		985		858		1022	3	3	240	
N 39/950		950	1062		1170		986		1214	6	6	745	
NU 29/950	30029/950 20329/950	950		1137		1032	986	1214		6	6	563	
NU 19/1060M	10329/1060H	1060		1270		1162	1096	1364		6	6	683	
NJ 18/1120/YA		1120	1202	1290		1182	1150	1330		5	5	311	
NU 18/1120X2		1120		1282		1180	1148	1332		5	5	333	
NU 18/1120X2/H/C		1120		1290		1182	1146	1334		5	5	333	
NU 6/1200	329/1200	1200		1410		1280	1236	1484		6	6	815	
NU 19/1250		1250	1498	1350								977	

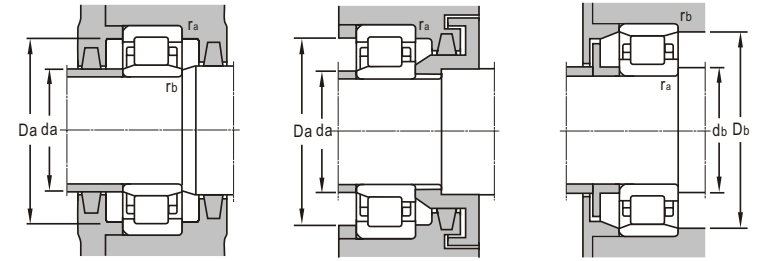
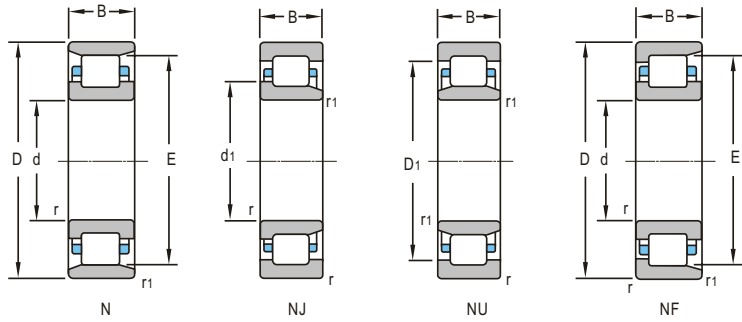

d 1320~1600mm

Boundary Dimensions					Basic Load Ratings		Limiting Speeds	
<i>d</i>	<i>D</i>	<i>B</i>	<i>r_{min}</i>	<i>r_{1min}</i>	Dynamic <i>C</i>	Static <i>C₀</i>	Grease	Oil
mm					kN		r/min	
1320	1720	175	7.5	7.5	4482	11034	190	240
	1720	175	7.5	7.5	4482	11034	190	240
1400	1700	175	7.5	7.5	7590	22100	70	90
1500	1800	150	7.5	7.5	5320	16790	170	200
	1820	140	7.5	7.5	5090	13900	60	80
1600	1950	155	7.5	7.5	6174	17694	150	180

Bearing Designations		Journal	Other Dimensions				Mounting Dimensions					Mass	
Present	Original		<i>d₁</i>	<i>D₁</i>	<i>E</i>	<i>F</i>	<i>d_{amin}</i>	<i>D_{amax}</i>	<i>d_{bmin}</i>	<i>r_{amax}</i>	<i>r_{max}</i>		
		mm						mm					kg
NU 19/1320	10329/1320	1320		1565	1440		1356	1684	6	6		1148	
NU 19/1320M	10329/1320H	1320		1565	1440		1356	1684	6	6		1164	
N 28/1400		1400	1506		1637		1370		1647	6	6	812	
NU 6/1500/YA	3-248	1500		1688.4	1586		1536	1764	6	6		805	
NU 18/1500C3		1500		1706	1585		1530	1790	6	6		758	
NU 18/1600	10328/1600	1600		1818	1695		1636	1914	6	6		1059	

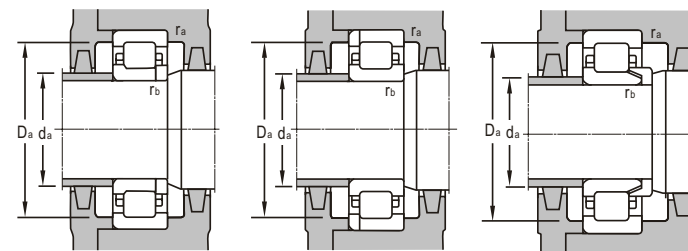
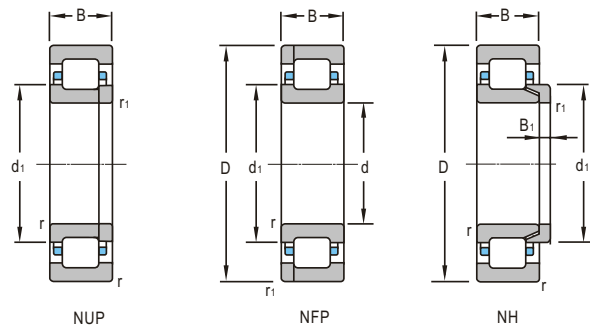

d 25~65mm

Boundary Dimensions					Basic Load Ratings		Limiting Speeds	
d	D	B	r _{min}	r _{1min}	Dynamic C	Static C ₀	Grease	Oil
mm					kN		r/min	
25	52	15	1	0.6	30.6	29.3	11000	14000
	62	17	1.1	1.1	36.6	33.0	9500	12000
	80	24	1.1	1.1	46.4	40.0	8500	10000
30	72	19	1.1	1.1	43.2	43.3	9000	11000
	72	27	1.1	1.1	61.5	64.1	8000	9500
32.5	62	16	1	1	21.9	13.5	10000	13000
35	80	21	1.5	1.1	64.2	39.2	8700	10960
	80	21	1.5	1.1	64.2	39.2	8700	10960
	80	21	1.5	1.1	80.2	83.3	2200	2750
	80	21	1.5	1.1	80.2	83.3	2200	2750
	80	21	1.5	1.1	70.6	66.2	7000	8500
	80	31	1.5	1.1	91.5	98.0	7000	8500
40	90	23	1.5	1.1	91.4	95.9	8000	10080
	80	18	1.1	1.1	49.1	43.0	7500	9000
	80	18	1.1	1.1	49.1	43.0	7500	9000
	90	23	1.5	1.5	83.6	88.4	6700	8000
45	100	25	1.5	1.5	101	103	6300	7500
	100	25	1.5	1.5	115	145	3000	3500
	100	25	1.5	1.5	115	145	3000	3500
50	90	20	1.1	1.1	59.5	63.4	6300	7500
	110	27	2	2	90.4	90.7	5000	6000
	110	27	2	2	108	125	5000	6000
55	100	21	1.5	1.1	87	100	6000	7000
	120	29	2	2	140	146	4800	5600
	120	43	2	2	148	162	4800	5600
60	110	22	1.5	1.5	76	87	5300	6300
	130	31	2.1	2.1	135	141	4300	5000
	130	31	2.1	2.1	146	151	4300	5000
	150	35	2.1	2.1	167	168	4300	5000
65	140	33	2.1	2.1	140	146	4000	4800

Bearing Designations		Journal	Other Dimensions				Mounting Dimensions				Mass
Present	Original		d ₁	D ₁	B ₁	B ₂	d _{amin}	D _{amax}	r _{amax}	r _{0max}	
		mm	mm				mm				kg
NUP 205ETN1	92205EA	25	34.7	43.5			29	47	1	0.6	0.14
NUP 305 ENTN1	192305EA	25	38.1	50.4			31	55	1	1	0.253
NH 405 X2M	62705H	25	39	48.7	4	8.83	32	72	1	1	0.853
NUP 306 EM		30	45	58			37	65	1	1	0.418
NUP 2306M		30	46	58.4			37	65	1	1	0.603
NUP 6/32.5	3-250	32.5	41.8	49.9			37	57	1	1	0.24
NUP307M	92307H	35	50.8	63.5			43	72	1.5	1	0.575
NUP307NM	192307HK	35	50.8	63.5			43	72	1.5	1	0.569
NUP 307EV/C9		35	52.2	64.4			44	71	1.5	1	0.552
NUP 307ENV/C9		35	52.2	64.4			44	71	1.5	1	0.546
NUP 307EF1		35	51.1	66.3			44	72	1.5	1	0.687
NUP 2307M	92607H	35	50.8	63.5			42	71	1.5	1	0.902
NUP2207X1V/C9YB2		35	55.2	70			53	81	1.5	1	0.812
NUP 208 ETN1	92208EA	40	54.2	65.6			47	73	1	1	0.396
NUP 208 M	92208H	40	54.2	65.6			47	73	1	1	0.468
NUP 308 EN	192308E	40	57.5	75			49	81	1.5	1.5	0.693
NUP 308 M		40	57.5	72.1			49	81	1.5	1.5	0.786
NUP 309 EF1		45	64.7	83.6			54	91	1.5	1.5	1.27
NUP 309 ENV		45	63.5	80.2			54	91	1.5	1.5	0.978
NUP 309 EV		45	63.5	80.2			54	91	1.5	1.5	0.988
NH 210EM		50	64	77.6	5	9.2	56.5	83.5	1.1	1.1	0.643
NH 310M	62310H	50	70.2	89.6	8	13.81	59	101	2	2	1.46
NH 310 EF1		50	71.2	91.7	8	12.81	59	101	2	2	1.72
NUP 211 EF1		55	70.9	86.3			61.5	91	1.5	1	0.757
NUP 311 EF1		55	100.6				64	111	2	2	1.69
NUP 2311M	92611H	55	76	98.5			64	111	2	2	2.89
NUP 212 M	92212H	60	77.6	92.2			68	102	1.5	1.5	1.09
NUP 312 M		60	84	106.5			71	120	2	2	2.16
NH312E/C9		60	84.3	110	9	14.29	71	120	2	2	2.29
NUP 412	92412	60	91	118.8			72	138	2	2	3.42
NUP 313M	92313H	65	91	114.9			77	129	2	2	2.65

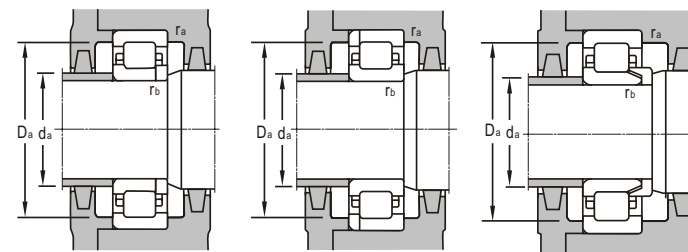
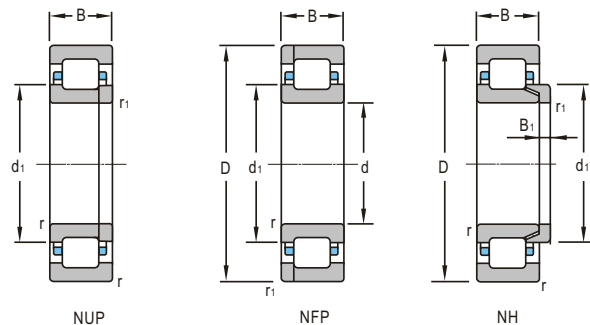

d 70~360mm

d	Boundary Dimensions				Basic Load Ratings		Limiting Speeds	
	D	B	r _{min}	r _{1min}	Dynamic C	Static C ₀	Grease	Oil
mm								
					kN		r/min	
70	110	20	1.1	1	64.9	80.9	6000	7000
	125	24	1.5	1.5	123	143	4500	5300
	125	31	1.5	1.5	145	185	4500	5300
	150	35	2.1	2.1	209	228	3600	4300
	150	35	2.1	2.1	173	190	3600	4300
75	130	25	1.5	1.5	122	144	4500	5300
80	140	33	2	2	187	245	4000	4800
85	210	52	4	4	357	386	3180	4010
100	180	50	2.1	2.1	335	445	3200	3800
	215	47	3	3	365	406	2400	3000
	215	47	3	3	390	440	2400	3000
120	215	40	2.1	2.1	250	299	2400	3000
	240	80	3	4	477	408	2520	3180
130	250	80	3	4	547	473	2360	2980
	250	80	3	3				
	250	80	3	4	604	807	2360	2980
	280	58	4	4	566	679	1800	2200
140	250	68	4	3	547	787	2000	2600
	310	108	4	4	1280	1800	1000	1300
150	225	35	2.1	2.1	216	320	2600	3200
190	340	92	4	4	1046	1555	1600	1900
240	500	95	5	5	1390	1610	1000	1300
260	400	65	4	4	659	1030	1500	1800
	400	65	4	4	659	1030	1500	1800
305	460	65	4	4	800	878	1200	1500
320	580	92	5	5	1825	2839	950	1200
360	520	82	5	5	1160	2100	1000	1300

Bearing Designations		Journal	Other Dimensions				Mounting Dimensions				Mass
Present	Original		d ₁	D ₁	B ₁	B ₂	d _{amin}	D _{amax}	r _{amax}	r _{0max}	
		mm	mm				mm				kg
NUP1014M		70	84	95.6			75	103.5	1	1	0.74
NUP 214 E		70	89.6	109			78	117	1.5	1.5	1.32
NUP 2214 M	92514EH	70	89.4	114.9			78	117	1.5	1.5	1.9
NUP 314ENM/C3 YA4		70	98	125			81	139	2	2	3.32
NUP 314NM		70	98	120.5			81	139	2	2	3.16
NUP 215EM		75	94.5	114			95	121	1.5	1.5	1.46
NUP 2216 EQ1/P63S0		80	101	122.5			89	131	2	2	2.38
NUP417Q1/C9S0	8G92417QT	85	127	170.5			105	190	3	3	9.7
NJP 2220X2M	152720H	100	127.9	151.3			111	169	2	2	5.9
NUP 320 EM		100	139	182.3			114	202	2.5	2.5	8.78
NH 320		100	139.1	182.3	13	20.23	114	201	2.5	2.5	9.74
NUP 224M	92224H	120	151.1	182.3			131	204	2	2	6.51
NJP 624Q/SO	152724QT	120	162	194			150	218	3	3	17.2
NJP626Q/SO	152726QT	130	170.5	205			152	228	4	4	18.7
NJP626M	152726H	130	170	205			152	228	4	4	18.7
NJP3226X1		130	171	206			152	228	4	4	18.5
NH326E/P64		130	182	227			148	262	3	3	20.5
NJP 2228Q1/C4S0		140	179	216			154	236	2.5	2.5	15.5
NH 2328X3V		140	203.5	261.5	16	31.2	158	292	3	3	42.8
NUP 1030Q1/P64		150	176	199			161	214	2	1.5	5.09
NH 2238EM	62538EH	190	240.8	296.8	13	26.12	208	322	3	3	44.1
NUP348M	92348H	240	329.2	402.7			262	478	4	4	111
NUP 1052		260	309.2	348.4			276	384	3	3	32.3
NUP 1052F1		260	309.2	348.4			276	384	3	3	32.3
NFP 661	22761	305	362				325	442	2.5	2.5	41.1
NH264	52264	320		415			340	560	4	4	125
NUP 1072X1M		360	416	463			382	498	4	4	61.3

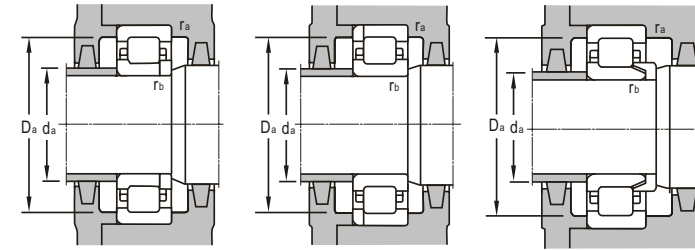
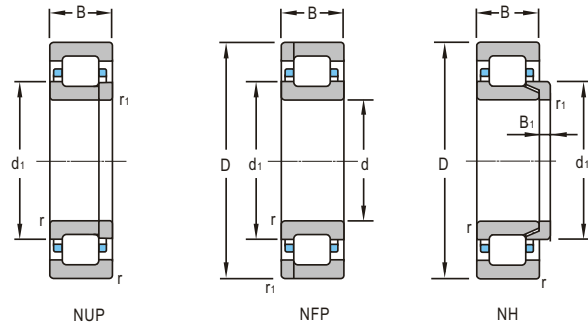

d 360~950mm

Boundary Dimensions					Basic Load Ratings		Limiting Speeds	
<i>d</i>	<i>D</i>	<i>B</i>	<i>r_{min}</i>	<i>r_{1min}</i>	Dynamic <i>C</i>	Static <i>C₀</i>	Grease	Oil
mm					kN		r/min	
360	540	106	5	5	1750	3240	900	1100
380	480	60	2.1	2.1	668	1437	1000	1300
419.1	558.8	76.2	4	4	1240	2550	950	1200
460	620	95	4	4	1769	3883	750	900
	680	100	6	6	2000	3700	800	950
500	670	100	5	5	2000	4510	750	900
508	622.3	95.25	3	3	1627	3858	800	950
530	710	106	5	5	2170	5200	700	850
558.8	685.8	100	3	3	1936	4560	700	850
560	920	128	7.5	7.5	3540	6370	500	600
600	730	90	3	3	1800	4240	670	800
630	780	112	4	4	2000	4800	560	670
650	900	170	6	6	4497	10875	480	560
660.4	812.8	107.95	6	6	2286	6000	600	700
670	820	112	3.5	3.5	2135	5700	500	600
700	930	160	6	6	3450	8400	500	600
710	950	106	6	6	2610	5530	500	600
723.795	908.05	120.65	5	5	3060	7620	500	600
750	1000	112	6	6	3070	6960	480	560
950	1250	175	7.5	7.5	5317	13932	340	400

Bearing Designations		Journal	Other Dimensions				Mounting Dimensions				Mass
Present	Original		<i>d₁</i>	<i>D₁</i>	<i>B₁</i>	<i>B₂</i>	<i>d_{amin}</i>	<i>D_{amax}</i>	<i>r_{amax}</i>	<i>r_{bmax}</i>	
		mm	mm				mm				kg
NJP2072 EM	2152172	360	423	475		405	380	520	4	4	96
NUP 2876/Y A	2092876K	380	417	444			392	468	2	2	26.4
NUP 6/419.1Q1/C9	92984Q U	419.1	465	515			437	540	3	3	55.4
NUP 2992 LY-N024	2092992	460	516	562			480	596	3	3	87
		460	537.6	600	25	40.49	488	652	5	5	144
NUP 29/500		500	560	610			522	648	4	4	105
NUP 6/508Q 1/C9	928/508 QU	508	544.6	586.6			520	611	2.5	2.5	64.7
NUP 29/530	20929/530	530	592	644			555	685	4	4	127
NUP 6/558.8	929/558.8 QU	558.8	599	646.5			570	674	2.5	2.5	84.2
NU1/560X2 +HJ1/560		560	693	797	25	48.4	592	888	6	6	381
NFP6/600M	228/600H	600	636	694			613	717	2.5	2.5	89.1
NFP6/630M	30228/630	630	678	731.5			648	762	3	3	119
NUP 6/650	927/650	650	739	808			678	872	5	5	349
NUP 6/660.4	929/660.4	660.4	709.4	763.8			688	784	5	5	131
NFP6/670M	30228/670H	670	724	769			684	805	3	3	142
NUP 6/700	927/700	700	781	845			728	902	5	5	308
NUP 19/710	10929/710	710	797	863			738	922	5	5	220
NFP6/723.795Q 1		725.795	784.2	852.8			700	932	4	4	198
NUP 19/750		750	840	917			778	972	5	5	255
NUP 29/950	20929/950	950	1058	1137			986	1214	6	6	612

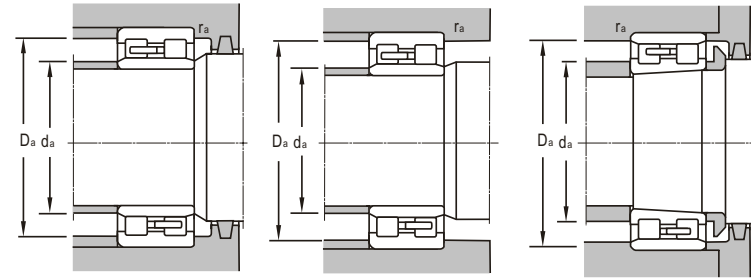
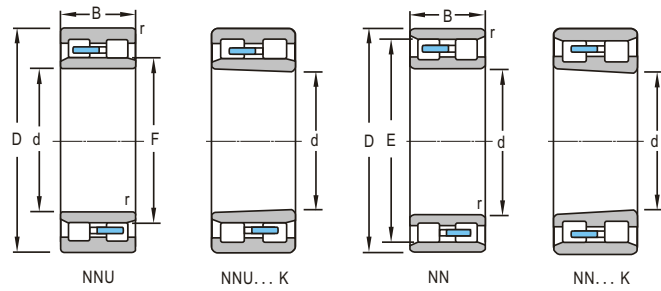

d 40~140mm

d	Boundary Dimensions			Basic Load Ratings		Limiting Speeds	
	D	B	r _{min}	Dynamic C	Static C ₀	Grease	Oil
mm				kN		r/min	
40	68	37	0.6	82.1	121	2000	
	68	38	0.6	100	142	2000	
	68	38	1.5	99.6	141	4800	6000
50	80	23	1	53	73.2	8000	9400
55	90	45	0.6	144	228	1500	
60	95	26	1.1	70.2	105	8500	10000
	95	26	1.1	70.2	105	8500	10000
70	110	30	1.1	95.8	145	7000	8500
	110	30	1.1	95.8	145	7000	8500
75	115	30	1.1	101	158	6700	8000
	115	30	1.1	101	158	6700	8000
80	125	34	1.1	123	194	6300	7500
	125	34	1.1	123	194	6300	7500
	125	34	1.1	123	194	6300	7500
85	130	34	1.1	122	195	6000	7000
90	140	37	1.5	142	226	5600	6700
	140	66	0.6	297	560	900	
100	150	37	1.5	161	274	5300	6000
	150	66	1.5	320	585	850	
105	160	41	2	201	328	4800	5600
110	170	80	1.8	389	711	570	750
	200	69.8	2.1	372	592	3100	3900
120	180	46	2	235	397	4300	5000
	180	79	1.8	406	765	530	700
130	200	52	2	294	498	4000	4500
	200	52	2	294	498	4000	4500
140	210	53	2	308	539	3800	4300

Bearing Designations		Journal	Other Dimensions		Mounting Dimensions					Mass
Present	Original		F	E	d _{amin}	d _{amax}	D _{amax}	D _{amin}	r _{amax}	
		mm	mm		mm					kg
NNF5008-2LSNV		40	47	61	44	50	65	63	0.6	0.535
NNF5008DA.V_C4.S3		40	46	62	44	50	65	63	0.6	0.524
NNCF5008V/P54 S3		40		61.74	44.6	45.9	63.4	68	1	0.545
NN 3010 K	3182110	50		72.5	55		75	74	1	0.421
NNF5011-2LS		55	63.5	81.5	60	67	85	83	0.6	1.16
NN 3012K		60		85.5	66.5		88.5	87	1	0.707
NN 3012		60		85.5	66.5		88.5	87	1	0.708
NN 3014K		70		100	76.5		103.5	101		0.963
NN3014K/ P4W 33		70		100	76.5		103.5	101	1	1.04
NN 3015K		75		105	81.5		108.5	106	1	1.12
NN 3015		75		105	81.5		108.5	106	1	1.13
NN 3016K		80		113	86.5		118.5	114	1	1.54
Nn3016		80		113	86.5		118.5	114	1	1.6
NN 3016K/ P4W 33		80		113	86.5		118.5	114	1	1.5
NN 3017K		85		118	91.5		123.5	119	1	1.59
NN 3018K		90		127	98		132	129	1.5	2.12
NNF5018-2LSNV		90	103.5	127.5	96	106	135	130	0.6	3.24
NN 3020 K		100		137	108		142	139	1.5	2.31
NNF5020-2LSV/Y A1		100	113	139	105	117	146	141	1.5	3.98
NN 3021K	3282222	105		146	115		150	148	2	2.99
NNF5022-2LSNV		110		154.5	117	125	165	160	1	5.37
NN 3222		110		178.5	139		182	180	2	9.52
NN 3024K		120		165	130		170	167	2	3.99
NNF5024-2LSNV		120		164	127	134	175	170	1	6.81
NN 3026K		130		182	140		190	183	2	5.76
NN 3026K/ W33		130		182	140		190	183	2	5.76
NN 3028 K		140		192	150		200	194	2	6.43

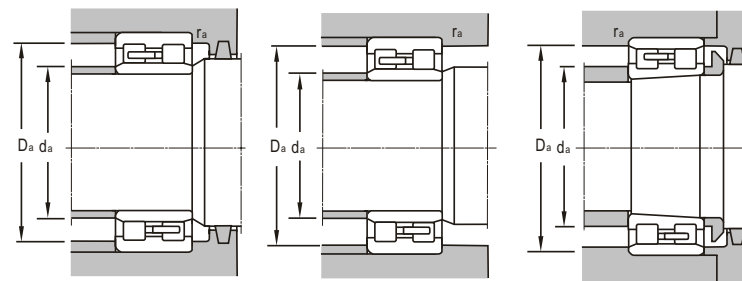
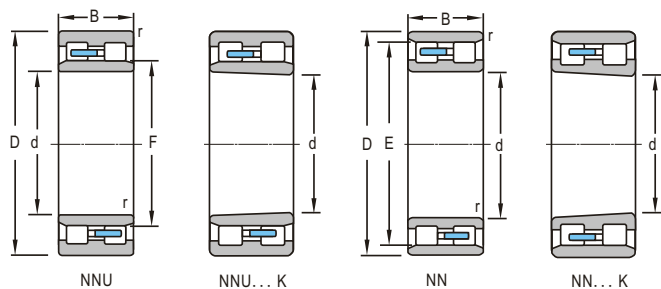

d 140~280mm

Boundary Dimensions				Basic Load Ratings		Limiting Speeds	
<i>d</i>	<i>D</i>	<i>B</i>	<i>r_{min}</i>	Dynamic <i>C</i>	Static <i>C₀</i>	Grease	Oil
mm				kN		r/min	
140	210	53	2	308	539	3800	4300
150	225	56	2.1	335	587	3600	4000
160	240	60	2.1	446	776	3400	3800
	240	60	2.1	446	776	3400	3800
	262	108	2	784	1600	380	500
170	260	67	2.1	450	805	3000	3400
180	260	84	2.1	567	1130	2000	2600
	270	120	2.1	815	1570	2000	2600
190	260	69	2	485	1060	1900	2400
	260	69	2	485	1060	2000	2600
200	280	80	2.1	480	1040	1900	2400
	280	80	2.1	480	1040	1900	2400
	310	82	2.1	653	1170	2400	2800
	310	82	2.1	653	1170	2400	2800
220	340	90	3	815	1480	2200	2600
	340	90	3	815	1480	2200	2600
	340	90	3	815	1480	2200	2600
240	300	60	2	446	1180	1100	1400
	320	80	2.1	546	1270	1700	2000
	360	92	3	892	1610	1600	1900
	360	92	3	892	1610	1600	1900
	400	160	4	1900	3600	1600	1400
260	360	100	2.1	785	1800	1400	1700
	360	100	2.1	785	1800	1400	1700
	360	100	2.1	785	1800	1400	1700
	400	104	4	1030	1920	1500	1700
	400	104	4	1030	1920	1500	1700
	400	189	1.1	2400	4720	330	
	400	189	1.1	2400	4720	330	
	440	180	5	2370	4270	1000	1300
280	380	100	2.1	760	1800	1300	1600

Bearing Designations		Journal	Other Dimensions		Mounting Dimensions					Mass
Present	Original		<i>F</i>	<i>E</i>	<i>d_{amin}</i>	<i>d_{amax}</i>	<i>D_{amax}</i>	<i>D_{amin}</i>	<i>r_{amax}</i>	
		mm	mm		mm					kg
NN 3028		140		192	150		200	194	2	6.56
NN3030K		150		206	161		214	208	2	7.87
NN3032K		160		223	171		229	221	2	9.25
NN3032K/ W33		160		223	171		229	221	2	9.18
NNF5032-2LSNRV		160		222.6	167	184	235	229	2	17.2
NN3034K		170		236	180		249	238	2	12.8
NNU4936X3/ W33		180	202		190		249	238	2	15
NNU4136X3		180	202		190	199	259	248	2	24
NNU 4938 K	438293 8	190	211		200	209	250	246	2	10.96
NNU4938K/P5W33YA		190	211.5		199	211	251	242	2	10.9
NN 4940K	418294 0	200		259	211	222	269	264	2	14.1
NN 4940 K/W33	418294 0Y	200		259	211	222	269	264	2	14.1
NN3040K		200		282	211		299	285	2	22.6
NN3040K/ W33		200		282	211		299	285	2	22.6
NN3044		220		310	230		327	313	2	30.1
NN3044K/ W33		220		310	230		327	313	2	29.1
NNU3044K/ W33		220	254		230		327	313	2	29.2
NNC4848V	448274 8H	240	253.5	279.5	247.5	255	290	287		
NNU4948		240	265		251	262	309		2	18.1
NN 3048		240		330	253		347	333	2.5	32.3
NN 3048K/ W33		240		330	253		347	333	2.5	32
NNU 4148M		240	282		256	278	384		3	81.8
NN 4952 K		260		334	271	288	349		2	30.2
NNU 4952/ C4W 33-1		260	292		271	288	349		2	31.7
NNU4952/ C3W 33-1		260	292		272	288	349		2	31.7
NN 3052 K	318215 2	260		364	276		384	367	3	44.3
NN 3052	328215 2	260		364	276		384	367	3	47.1
NNF5052- 2LSNV /W33		260	292.5	372.5	276	298	385	368	3	80.2
NNF5052- 2LSNV /C9W 33		260	292.5	372.5	276	298	385	368	1.1	80.2
NNU4152/W33		260	306		276	300	424	407	3	112
NNU4956		280	312		291	308	369		2	33.6

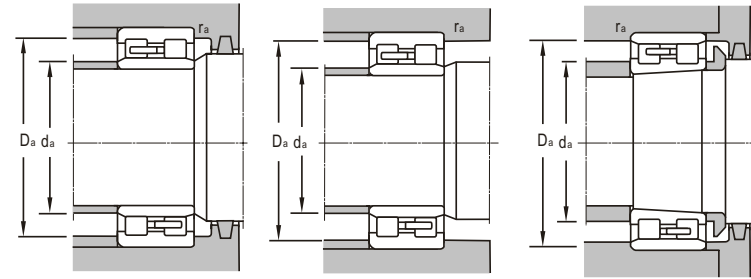
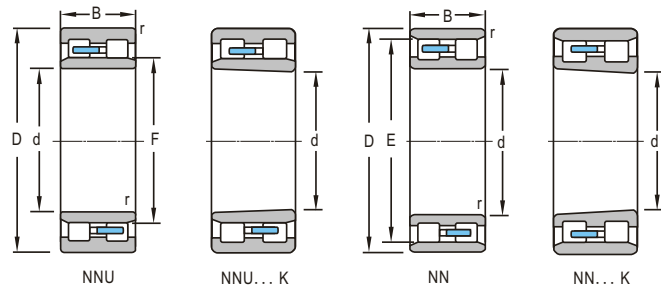

d 280~400mm

d	Boundary Dimensions			Basic Load Ratings		Limiting Speeds	
	D	B	r _{min}	Dynamic C	Static C ₀	Grease	Oil
	mm			kN		r/min	
280	420	106	4	1110	2160	1800	2000
	420	106	4	1110	2160	1800	2000
	420	106	4	1110	2160	1800	2000
	460	180	5	2400	4250	950	1200
300	460	118	4	1280	2430	1700	1900
	460	118	4	1280	2430	1700	1900
	460	118	4	1280	2430	1700	1900
	460	118	4	1280	2430	1700	1900
	460	118	4	1580	3200	320	600
	460	118	4	1580	3200	320	600
320	440	118	3	1110	2640	1100	1400
	440	118	3	1110	2640	1100	1400
	440	118	3	1110	2640	1100	1400
	480	121	4	1300	2600	1600	1800
	480	121	4	1570	2970	920	1200
340	460	118	3	1270	3250	1100	1300
	520	133	5	1670	3300	1100	1300
	520	133	5	1670	3300	1100	1300
	520	133	5	1912	4084	550	610
360	480	118	3	1270	3250	1100	1300
	540	134	5	1630	3240	1000	1200
380	540	180	4	2500	5690	900	1050
	540	180	4	2880	6630	900	1050
	560	135	5	1690	3450	940	1100
	560	135	5	1690	3450	940	1100
	560	135	5	1690	3450	940	1100
	620	194	5	2700	5800	500	700
400	540	106	4	1240	2400	780	980
	540	106	4	1240	2400	780	980
	540	106	4	1240	2400	780	980
	600	148	5	2140	4420	1200	1400
	600	148	5	2140	4420	1200	1400
	600	148	5	2140	4420	1200	1400
	600	148	5	2140	4420	1200	1400
	600	148	5	2140	4420	1200	1400
	650	250	6	4610	8970	710	890

Bearing Designations		Journal	Other Dimensions		Mounting Dimensions					Mass
Present	Original		F	E	d _{amin}	d _{amax}	D _{amax}	D _{amin}	r _{amax}	
		mm	mm		mm					kg
NN 3056 K		280	384		296		404	387	3	49.1
NN 3056		280	384		296		404	387	3	49.9
NN3056K/ W33		280	384		296		404	387	3	48.9
NNU4156		280	326		300	318	440		4	120
NN 3060		300	418		316		444	421	3	71.5
NN 3060/ W33		300	418		316		444	421	3	71.1
NN 3060 K		300	418		316		444	421	3	69.8
NN3060K/ W33		300	418		316		444	421	3	69.4
NNF3060V/ W33		300	346	418	316		444	421	3	69.8
NNCF3060V		300	346	418	316		444	421	3	69.8
NN 4964 K/ W33	4182 964Y	320		409	334	355	427		2.5	52
NNU 4964 K/ W33		320	359		334	355	427		2.5	54.7
NNU 4964 K/ P5W33		320	359		334	355	427		2.5	54.7
NN 3064 K	3182 164	320		438	336		464	442	3	77.9
NNU3064/ W33		320	366		336	343	464	400	3	76.4
NN 4968 K/ W33	4182 968Y	340		433	353	375	447		2.5	53.8
NN 3068 K	3182 168	340		473	360		500	477	4	101
NN 3068	3282 168	340		473	360		500	477	4	104
NN3068V	3682 168U	340		473	360		500	477	4	100
NNU4972K		360	396		374	395	466		2.5	57.8
NN 3072 K	3182 172	360		493	380		520	497	4	106
NNU4076X1/ W33XYA3		380	420		400	418	520		4	132
LY-N025		380	420		400	418	520		4	132
NN 3076		380		515	400		540	516	3.5	114
NN3076K		380		515	400		540	516	4	110
NN3076K/ W33X		380		515	400		540	516	4	110
NN 3176 V	3202 776	380		560	458		560	534	4	221
NN3980K	3182 980	400		505	430		510	486	3	71.3
NN 3980 K/ W33	3182 980Y	400		505	430		510	486	3	71.3
NN 3980 K/ W33	3282 980	400		505	430		510	486	3	73.6
NN 3080 K		400		549	420		580	533	4	149
NN3080K/ W33		400		549	420		580	533	4	149
NN 3080		400		549	420		580	533	4	150
NN3080/ W33		400		549	420		580	533	4	150
NNU 4180 M/ HC/ C3		400	463		424	455	626		5	319

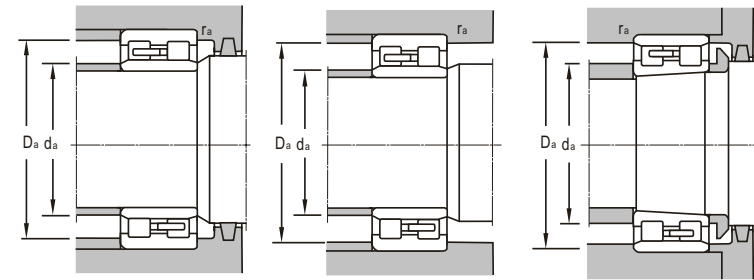
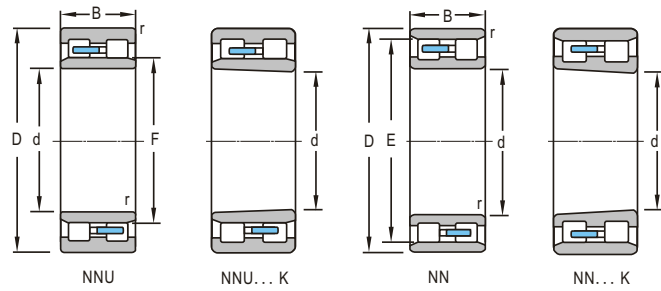

d 420--600mm

d	Boundary Dimensions			Basic Load Ratings		Limiting Speeds		
	D	B	r _{min}	Dynamic C	Static C ₀	Grease	Oil	
mm								
420	620	150	5	2170	4560	1000	1300	
	620	200	5	3230	6850	740	920	
	760	280	7.5	6000	11300	510	640	
440	640	230	5	4340	9180	700	850	
460	620	160	4	2230	5210	800	950	
	620	160	4	2230	5210	800	950	
	680	163	6	2590	5470	750	890	
	680	163	6	2590	5470	750	890	
	680	163	6	2590	5470	750	890	
800	250	7.5	5830	11200	560	700		
480	700	165	6	2642	5680	700	850	
500	670	170	5	2360	6200	700	850	
	670	170	5	2570	6440	700	850	
	720	167	6	2840	6140	950	1100	
	830	325	7.5	7090	14400	460	600	
530	710	136	5	2270	5130	670	800	
	710	180	5	2820	7690	670	800	
	760	260	6	5353	12834	600	700	
	870	335	7.5	7800	15900	510	640	
560	735	170	5	3030	7560	560	730	
	750	140	5	2370	4860	670	800	
	750	140	5	2450	5780	800	1000	
	750	190	5	3480	8660	670	800	
	780	180	6	3600	8270	600	700	
	780	180	5	3600	8270	600	700	
	820	195	6	3620	7890	560	670	
	820	195	6	3620	7890	560	670	
	820	195	6	3620	7890	560	670	
	600	800	200	5	3350	9320	700	900
		800	200	5	3580	10200	560	670
820		287.5	5	6080	16600	530	630	
870		270	6	6450	15500	500	600	
980		375	7.5	9950	21000	370	480	

Bearing Designations		Journal	Other Dimensions		Mounting Dimensions					Mass
Present	Original		F	E	d _{amin}	d _{amax}	D _{amax}	D _{amin}	r _{amax}	
mm										
NN3084K		420		569	440	477	600	588	4	151
NNU 4084/W33/C3		420	469		440	463	601		4	204
NNU 4184 X1/HC/P6		420	508		448	499	732		6	587
NNU6/400/HC		440	482		466	475	614		5	250
NNU 4992/W33		460	504		476	504	604		3	
NNU 4992K/W33		460	504		476	504	604		3	
NN 3092 K		460		623	484		656	627	5	204
NN 3092		460		623	484		656	627	5	204
NN3092/W33		460		623	484		656	627	5	204
NNU 3192 X3/HC W33		460	554		489	554	771		6	550
NN3096K/W33		480		643	506		674	648	5	214
NNU 49/500/YA	44829/500	500	548		520	548	650		4	166
NNU 49/500K/W33		500	551		520	548	650		4	169
NN30/500K/W33		500		664	526		694	668		223
NNU41/500/HC		500	582		533	568	587	797	6	710
NN39/530K		530		663	550	582	690		4	149
NN 49/530 K/P4W33		530			549	580	691	673	4	203
NNU6/530/W33XYA3		530	587		550		740		5	387
NNU 41/530 M/HC W33		530	618		580	608	842		6	781
NNU19/560X1/HCW33		560	603		580	590	715	695	5	190
NN 39/560	32829/560	560		705	576		735	711	4	188
NN39/560K		560		705	590	623	725	715	5	172
NNU 49/560/SPC3W33X		560	617		580	644	730		4	234
NN 6/560	2827/560	560		725	580		765	732	5	266
NN6/560KW/W33		560		725	580		765	732	4	257
NN 30/560 KF1	31821/560 W	560		755	600		794	765	5	341
NN30/560KF1/W33		560		755	600		794	765	5	336
NN30/560F1/W33		560		755	600		794	765	5	347
NN49/600K		600		750	630	662.8	770	760	5	281
NN 49/600 K	41829/600	600		755	620	662	780		4	257
NNU6/600/HC		600	660		620	651	805		5	470
NNU40/600X2		600	672		626	653	844		6	559
NNU41/600M/W33		600	699		633	682	947	898	6	1117

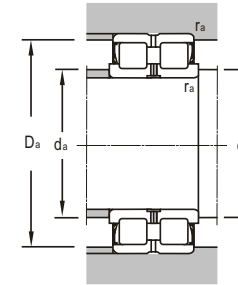
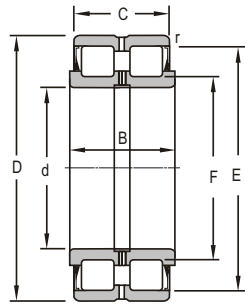

d 40~260mm

Boundary Dimensions					Basic Load Ratings		Limiting Speeds		Mass
<i>d</i>	<i>D</i>	<i>B</i>	<i>C</i>	<i>r_{min}</i>	Dynamic <i>C</i>	Static <i>C₀</i>	Grease	Oil	
mm					kN		r/min		
40	68	37	38	0.6	82.1	121	2000		0.535
	68	38	38	0.6	100	142	2000		
55	90	45	46	0.6	144	228	1500		1.16
85	130	59		0.6	248	459	930		2.79
90	140	66	67	0.6	297	560	900		3.24
	140	66		0.6	319	580	900		
100	150	66	67	1.5	320	585	850		3.98
110	170	79		0.6	389	711	800		7
120	180	79		0.6	406	765	750		7.5
140	210	94		0.6	608	1150	650		12.1
160	240	108	109	0.6	800	1590	500		17.3
170	230	80		1	544	1147	450		9.09
260	400	189	190	1.1	2400	4720	330		80.2
	400	189	190	1.1	2400	4720	330		

Bearing Designations		Journal	Other Dimensions								Mass
Present	Original		<i>F</i>	<i>E</i>	<i>d_{amin}</i>	<i>d_{amax}</i>	<i>d_{bmin}</i>	<i>D_{amax}</i>	<i>D_{amin}</i>	<i>r_{amax}</i>	
		mm	mm								kg
NNF5008-2LSNV		40	47	61	44	50	60	65	63	0.6	0.535
NNF5008DA.V.C4.S3		40	46	62	44	50	60	65	63	0.6	0.524
NNF5011-2LS		55	63.5	81.5	60	67	77	85	83	0.6	1.16
NNF5017-2LSNRV		85	98.2	120.2	91	102	125	123	0.6		2.79
NNF5018-2LSNV		90	103.5	127.5	96	106	124	135	130	0.6	3.24
NNF5018-2LSNRV		90	103.5	127.5	96	106	135	130	0.6		3.71
NNF5020-2LSV/YA1		100	113	139	105	117	130	146	141	1.5	3.98
NNF5022-2LSNRV		110	124.5	154.5	116	129	165	158	0.6		7
NNF5024-2LSNRV		120	134	164	126	138	175	168	0.6		7.5
NNF5028-2LSNRV		140	157.5	195.5	146	163	205	199	0.6		12.1
NNF5032-2LSNV/W33		160	180.6	222.6	165	189	210	234	226	0.6	17.3
NNF170-2RV		170	184	218	176	185	225	221	1		9.09
NNF5052-2LSNV/W33		260	292.5	372.5	276	298	305	385	368	3	80.2
NNF5052-2LSNV/C9W33		260	292.5	372.5	276	298	305	385	368	1.1	80.2

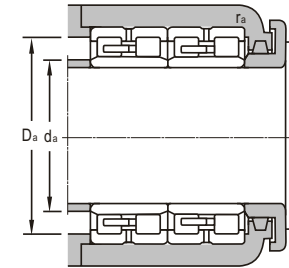
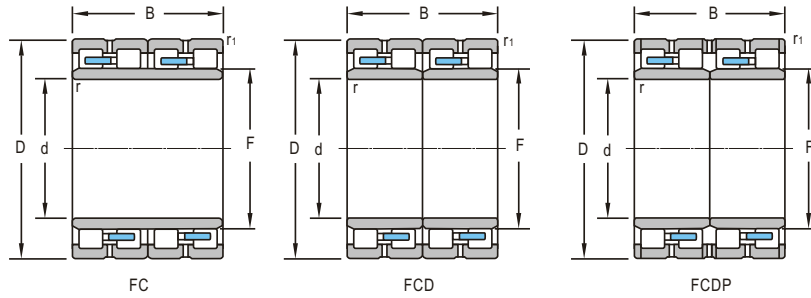

d 90~280mm

Boundary Dimensions						Basic Load Ratings	
<i>d</i>	<i>D</i>	<i>B</i>	<i>F</i>	<i>r_{min}</i>	<i>r_{1min}</i>	Dynamic <i>C</i>	Static <i>C₀</i>
mm						kN	
90	140	70	105	1.5	1.1	219	423
100	140	104	111	1.5	1.1	333	793
131	196.85	128	148	2.1	2.1	604	1200
140	210	125	158	2	2	622	1270
	210	155	158	2	2	786	1710
150	225	120	169	2	2	658	1289
160	230	130	180	2	2	703	1560
170	230	160	185.6	2.1	2.1	894	2220
180	260	168	202	2.1	2.1	1152	2250
	260	168	202	2.1	2.1	1152	2250
	260	168	202.1	2.1	2.1	1152	2250
190	260	168	212	2.1	2.1	870	2340
	270	200	212	2.1	2.1	1359	3020
	270	200	212.3	2.1	2.1	1359	3020
200	290	192	226	2.1	2.1	1386	2880
	290	192	226	2.1	2.1	1330	3160
210	300	210	234	2.1	2.1	1520	3170
220	310	192	246	2.1	2.1	1512	3285
230	330	206	260	2.1	2.1	1683	3600
250	340	230	176	2.1	2.1	1720	4680
260	370	220	292	3	3	1944	4460
	370	220	292	3	3	1944	4460
	370	220	292	3	3	2012	4620
270	380	275	300	2.1	2.1	2620	6990
280	390	220	312	3	3	2016	4760

Bearing Designations		Other Dimensions				Mass
Present	Original	<i>d_{amin}</i>	<i>D_{amin}</i>	<i>D_{amax}</i>	<i>r_{amax}</i>	
		mm				kg
FC182870		98	126	132	1	4.08
FC2028104		108	129	135	1	5.18
BFC 2639128 X3/P5		142	181	186	1.5	13.4
FC2842125		151	192	199	1.5	15.6
FC2842155		151	192	199	1.5	18.9
FC3045120		161	207	216	1.5	15.9
FC3246130		171	214	219	1.5	19.8
BFCD3446160/YA		178	218	220	6.5	18.8
FC3652168		191	240	248	1.5	30
FC3652168/YA		191	240	248	1.5	30
FC3652168-1		191	240	248	1.5	30
FC3852168/c4		203	243	249	1.5	38.3
FC3854200		215	252	259	1.5	38.3
FC3854200-1		215	252	259	1.5	37.1
FC4058192		212	268	278	2	42.8
FC4058192F/P54 S0		212	268	278	2	43.1
FC4260210		223	278	287	2	47.5
FC4462192		233	286	298	2	47.1
FC466206/S0		243	306	317	2	59.3
FC5068230/HC/P64	6672164Y	263	318	329	1.5	19.2
FC5274220		274	342	356	2.5	77.3
FC5274220A	672764Y	274	342	356	2.5	77.3
FC5274220/YA		274	342	356	2.5	80.8
FCD 5476275 WB/P69	972768Y	283	352	369	1.5	100
FC5678220		294	362	376	2.5	83.4

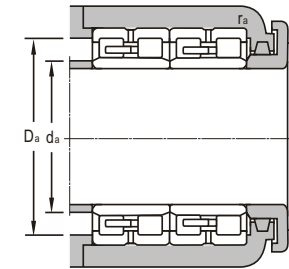
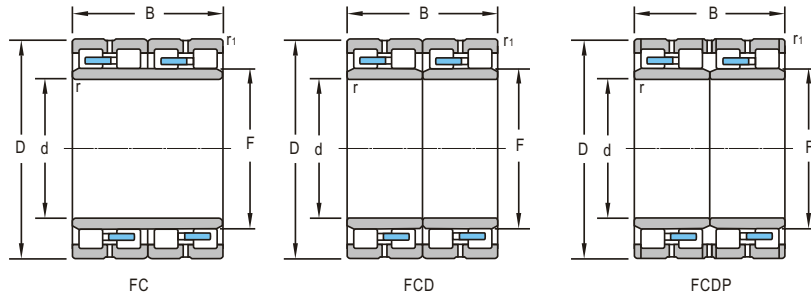

d 280~460mm

Boundary Dimensions						Basic Load Ratings	
<i>d</i>	<i>D</i>	<i>B</i>	<i>F</i>	<i>r_{min}</i>	<i>r_{1min}</i>	Dynamic <i>C</i>	Static <i>C₀</i>
mm						kN	
280	390	275	312	3	3	2472	6190
	390	275	308	3	3	2530	6720
290	410	240	320	4	4	2150	5260
	410	240	320	4	4	2220	5450
300	420	240	332	4	4	2060	5020
	420	300	332	3	3	3366	7920
	420	300	332	3	3	3366	7920
310	420	300	338	4	4	2800	7520
320	480	290	364	4	4	3474	8847
	480	350	364	4	4	4455	9720
	480	350	364	4	4	4455	9720
	480	350	364	4	4	5779	13000
340	480	350	378	4	4	3790	10334
	480	350	378	4	4	3790	10334
360	510	370	397	8X20	4	4330	11300
370	520	380	409	4	4	4438	11815
	530	400	413	5	5	4650	12600
380	540	400	422	4	4	5148	12600
400	560	410	445	5	5	6330	15800
	560	410	445	5	5	4680	13500
	560	410	445	12X20	4	5590	16400
410	600	440	460		5	6640	17700
420	620	90	470	5	5	1500	2620
440	620	485	487	12.5X20	4	7090	20200
447.295	635.176	463.55	495	6	3	8250	20000
460	650	470	509	5	5	7920	20160

Bearing Designations		Other Dimensions				Mass
Present	Original	<i>d_{amin}</i>	<i>D_{amin}</i>	<i>D_{amax}</i>	<i>r_{amax}</i>	
		mm				kg
FCDP5678275/HCYB		293	362	377	2.5	105
FC5678275		293	363	377	2	101
FC5882240		304	380	396	3	97.5
FC5882240/YA		304	380	396	3	91.9
FC6084240		314	392	406	3	98.3
FCD6084300		314	392	406	2.5	128
FCDP6084300		314	392	406	2.5	133
FCD 6284300 HC/P64		328	391	402	3	117
FCDP6496290		346	462	466	3	186
FC6496350		346	462	466	3	225
FCD6496350		346	462	466	3	225
FCDP6496350		346	462	466	3	225
FCD6896350		355	446	465	2.5	230
FCDP6896350		355	446	465	2.5	230
FCDP72102370/HC		377	470	493	3	234
FCDP74104380		389	481	500	3	244
FCDP 74106400/HC/C4		382	456	510	4	313
FCD76108400		397	502	523	3	291
FCDP80112410		419	525	547	4	320
FCDP 80112410		419	525	547	4	320
FCDP80112410-1		419	525	547	2	322
FCDP 82120440 HC/C4		423	550	580	4	423
NU1084 (NU 1084 M)		440	590	600	4	90.1
FCDP88124450WB1		480	570	595	2	444
LY-N040						490
FCDP92130470M/HC		484	609	626	4	500



Cylindrical Roller Bearings

four-row

LYC®

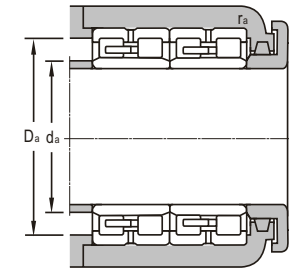
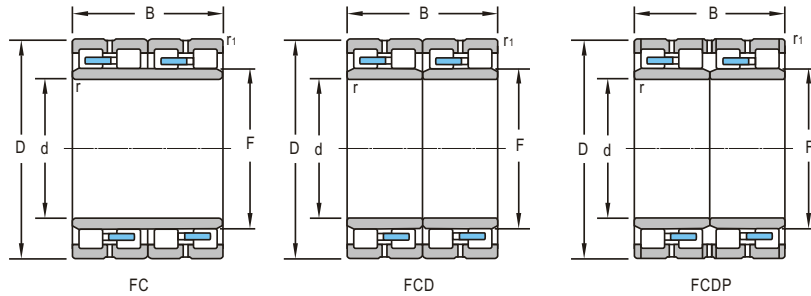

d 480~748mm

Boundary Dimensions						Basic Load Ratings	
<i>d</i>	<i>D</i>	<i>B</i>	<i>F</i>	<i>r_{min}</i>	<i>r_{1min}</i>	Dynamic <i>C</i>	Static <i>C₀</i>
mm						kN	
480	650	450	525	6	6	7425	19080
	650	450	525	6	6	7425	19080
	680	500	532	6	6	8217	19800
	700	400	538	5	5	8568	21600
500	670	450	540	6	6	9800	20200
	720	530	568	6	6	10000	28000
520	735	535	574.5	6	6	9620	27600
530	760	520	587	12X20	5	11800	27900
560	820	600	625	6	4	12780	35600
	820	630	625	6	6	14000	35800
570	815	594	628	6	6	12080	30180
600	870	640	672	6	6	14900	26100
	870	640	669	6	6	15000	37700
	870	640	669	6	6	15000	37700
	870	640	669	6	6	15000	37700
610	870	660	680	6	6	14500	44600
	870	660	680	6	6	14500	44600
650	900	650	704	7.5	7.5	14200	42100
	900	650	704	20X11.20'	7.5	14200	42100
	920	690	723	18X20	6	14500	46300
	920	670	723	8X20	7.5	14000	41900
	920	670	723	17X20	7.5	14000	41900
658	1075	650	766	6	6	18450	38700
680	980	640	760	18X20	4	15300	46000
690	980	715	767.5	6	4	17820	55330
	980	750	766	7.5	7.5	17000	52000
	980	750	766	20X20	7.5	17000	52000
	980	750	766	20X20	7.5	17000	52000
748	1135	690	851	6	4	19800	45900

Bearing Designations		Other Dimensions				Mass
Present	Original	<i>d_{amin}</i>	<i>D_{amin}</i>	<i>D_{amax}</i>	<i>r_{amax}</i>	
		mm				kg
FCD96130450		500	610	630	4	453
FCDP96130500		500	610	630	4	448
FCDP96136500		500	632	660	4	607
FCDP96140400	672796Y	500	648	680	4	508
FCDP100134450	6728/500Y	520	629	650	4	441
FCDP100144530		520	629	650	4	248
FCD104147535/HC		541	680.5	714	4	721
BFCDP106152520/YB		548	705	735	5	804
FCDP112164600		577	757	803	4	1071
FCD112164630		577	757	803	4	1134
FCD114163594	9727/570Y	595	757	730	4	1066
FCDP120174640K		625	808	845	4	1286
FCDP120174640K1		621	809	849	4	1294
FCDP120174640K2		621	809	849	4	1294
FCDP120174640K2		621	809	849	4	1294
BFCDP 120174640/HC/P64YA		623	791	845	4	1303
BFCDP 120164575/HC P64		618	760	805	2.5	920
BFCDP 122174660/P5		625	799	845	6	1316
FCDP130180650HC/P64		662	830	872	5	1270
BFCDP130180650/HC		690	830	850	6	1270
BFCDP130184690		680	856	890	6	1510
BFCDP130184670-2		680	855	890	6	1492
BFCDP130184670-3		680	855	890	6	1492
FCDP132215650X3	6729/658	621	809	872	5	2400
BFCDP136196640/HC		748	895	915	3	1633
FCDP138196715		720	911.5	950	4	1862
BFCDP 138196750-4/P5		771	896	950	5	1894
BFCDP138196750-4		720	910	954	5	1894
BFCDP138196750-5/HC		720	910	954	5	1900
FCDP150227690X3	6729/748	777	1038	1100	4	2570

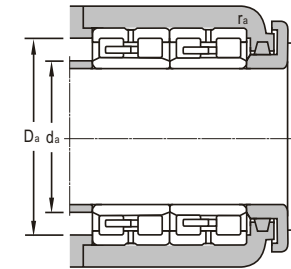
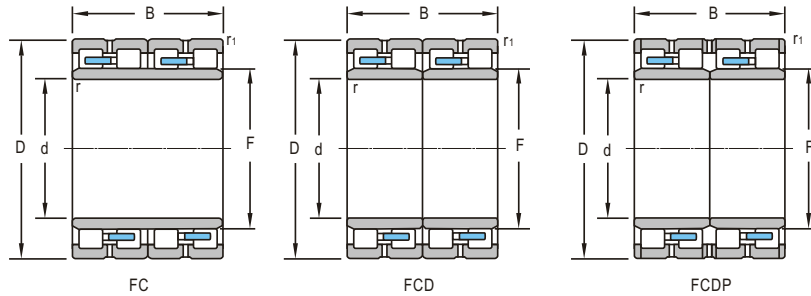

d 780~950mm

Boundary Dimensions						Basic Load Ratings	
<i>d</i>	<i>D</i>	<i>B</i>	<i>F</i>	<i>r_{min}</i>	<i>r_{1min}</i>	Dynamic <i>C</i>	Static <i>C₀</i>
mm						kN	
780	1070	780	849	17X20	7.5	19600	64500
800	1080	700	870	7.5	3	19000	57000
	1080	700	878	7.5	3	17850	53650
820	1080	700	891	15X20	3	16900	58800
	1130	800	903		6	21700	67000
850	1150	840	928	7.5	7.5	30500	67500
900	1220	840	989	7.5	7.5	23600	72000
	1220	840	989	7.5	7.5	27000	81200
950	1300	850	1044	7.5	7.5	29000	92000

Bearing Designations		Other Dimensions				Mass
Present	Original	<i>d_{amin}</i>	<i>D_{amin}</i>	<i>D_{amax}</i>	<i>r_{amax}</i>	
		mm				kg
BFCDP156214780/HC Yb1		870	1009	1039	6	2159
FCDP160216700		827	1010	1050	5	1912
BFCDP160216700/YA		827	1010	1050	5	1981
BFCDP160216700-2/P6		827	1010	1050	5	1981
BFCDP164226800-1/P6		835	1040	1100	4	2533
FCDP170230840		875	1088	1130	5	2529
FCDP180244840		931	1145	1190	5	3010
BFCDP180244840/YA/P64		923	1130	1190	5	2984
FCDP190260850	6727/950Y	980	1210	1270	5	3523

Spherical Roller Bearings

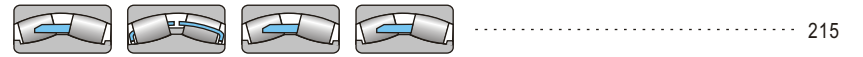

Spherical Roller Bearings



Split Bearings

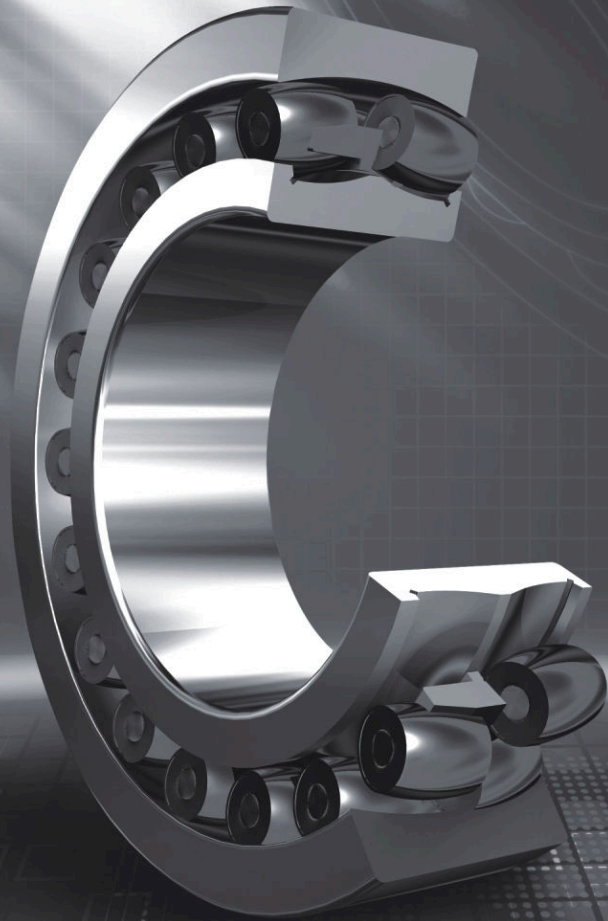



Spherical Roller Bearings

LYC's spherical roller bearing consists of an outer ring with spherical raceway and an inner ring with double-raceway, one or two cages, and one group of spherical rollers. Due to the center of spherical raceway of outer ring which is coinciding with the center of bearing, this makes it have a self-aligning property. This kind of bearing can adjust angular error or deflection caused by the angle of the axle and bearing housing or axle bend.

LYC's spherical roller bearing has a high load carrying capacity for radial load and axle load in two directions. It is especially suitable for carrying heavy loads and impact loads, but this type of bearing permits a lower limiting speed.

The permissible aligning angle of the spherical roller bearing working in normal conditions is 1° ~2.5°. If bearings of this type have seals, then this function would be reduced.

The relevant data for aligning angle of different dimensions can be referred to the catalogue "bearing type selection".

Type C

The bearings of type C are flangeless on two sides of the inner ring, two cages, and movable flange between two rows of spherical rollers. When the bearing is rotating, the middle flange can move in the axial direction. When the bearing is carrying an axial load, the load on the two rows can be adjusted. It makes the load distribution equal in order to avoid stress concentrated and single row roller loaded.

Type CA

The bearings of type CA have flanges on two sides of the inner ring, one cage, and movable spacer in the middle of two rows of the spherical rollers. When the bearing is rotating, the middle spacer can move in the axial direction. When the bearing is carrying axial load, the load on the two rows can be adjusted. The load is distributed equally to avoid stress concentration. If there is no movable flange, the cage will have this function.

Spherical Roller Bearings with Fixed Flange

Spherical roller bearings with fixed flange have flanges on the both sides of inner ring. In the middle, there is a fixed middle flange at the two sides of inner ring, and two cages. The rollers are spherical type which is the same with type C, CA, but the roller length in axial direction is not symmetrical. When the bearing rotates, the middle flange ring can not move in the axial direction, but,

can allow the rollers work properly. When the bearing is carrying axial direction load, it can not adjust the load on the two rows of rollers, because this will make the single row of rollers loaded or stress concentrated. Although this kind of bearing tends to be used by type C and CA, but, in some working condition, it still has advantages like occasions where axial load is not big, and vibration load is relative heavier.

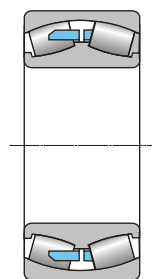

Sealed Bearings

LYC's spherical roller bearings are generally open style. Closed types with seals at both sides are also provided. This can be divided into contact and non-contact style (low friction).

The bearings with seals on double sides are filled with grease before leaving factory. The quantity of grease occupies 25%-35% of the effective space of bearing. If customers have a special requirement, other brands of grease can be supplied, or the filled quantity can be adjusted. When installing, they are not allowed to be cleaned or heated over 80°C, otherwise it is easy to damage bearings or make grease deteriorate and loss. Under the ambient temperature 30°C ~100°C, the bearings could work in good condition. In normal working conditions, spherical roller bearings with seals do not need to be replenished with lubrication grease. However, under heavy load and high speed, or temperature over +70°C, the bearings need to be refilled with grease. The aligning function would be reduced when spherical roller bearings are sealed.

Vibrating Machine Bearing

When spherical roller bearings are applied to vibrating machine such as vibration sieve, crusher etc., it will make the roller and cage have higher acceleration. Accordingly when designing, we need to take special account to satisfy the working condition. LYC can provide special designed spherical roller bearings in these applications.

Split Bearing

The inner ring and outer ring advantage of LYC's split spherical roller bearing are vertically split into two parts with some angle. This kind of bearing will have almost the same performance compared with bearings with common structures, and have a large load carrying capability. This bearing is suitable for the applications where bearings cannot be axially mounted. But, due to inner and outer ring raceway having a split face, then the rotating speeds are relatively lower.

Other Design Tapered Bore

LYC's spherical roller bearing bore normally is cylindrical. But for some parts of the dimensions and specifications, tapered hole can also be provided with the taper 1:12 or 1:30 (suitable for 241, 240 dimension series). In this case, the original code should be added by K or K30 behind the bearing type. Through using the adapter sleeve to fix the bearing on the shaft, it will be very convenient to be mounted and dismounted.

Lubrication Groove and Hole

In order to lubricate easily, LYC can provide the bearing with groove and holes on outer ring, in this case, W33 should be added behind the original bearing code. If the outer ring has only one lubrication hole, W20 will be added behind. LYC can design spherical roller bearings with other structures, such as bearings with snap ring groove on the outer ring, a single row spherical roller bearing (angle error can be 4°), and many other types etc. If customers require, then please consult LYC technical department.

LYC can also design and manufacture spherical roller bearings with special structures according to customer's requirements.

Cage

In the LYC spherical roller bearings, the cages of type C are normally pressed steel cages, fiber glass reinforced ployimide or other engineering plastics. CA type adopts a brass solid cage. Different kinds of material have different codes. See "cap" chapter.

Axial Load Carrying Capacity

Due to the special structure of the spherical roller bearing, it can take pure radial load, even pure axial load.

The spherical roller bearing with an adapter sleeve will normally be fixed to a plain shaft without a shoulder. The value of the axial load will depend upon the friction between the shaft and the adapter sleeve. If the bearing is mounted in

the right way, the permissible axial load can be calculated from

$$F_a = 0.003Bd$$

where

B-Bearing width, mm
d-Bearing inner diameter, mm

Minimum Load

In order to keep bearings working in a good condition, a minimum load must be imposed on the bearings, particularly on bearings working at high speeds, high accelerations, or with load direction changing frequently, because under these working conditions, inertial force of balls and cage and lubricant friction will have bad influence on the rotation of bearings, and detrimental sliding movement may be caused.

The minimum load of a spherical roller bearing can be obtained from

$$F_{min}=0.01C_0$$

where

C₀- Basic static load rating

When bearings are started at low ambient temperatures or in the condition that the viscosity of lubricant is very high, larger a minimum load is probably needed. Usually, the weight of bearing supporting parts plus the load on the bearing have been enough to over the minimum load. If the weight cannot be up to the minimum load, then extra radial load must be imposed on this type of bearing in order to meet the requirement of minimum load.

Dimension, Tolerance, Clearance

LYC's standard spherical roller bearing dimension are according to GB/T273.3 <Rolling Bearing, Radial Bearing, and Boundary Dimension General Specification>, GB/T288 <Rolling Bearing, Spherical Roller Bearing, and Boundary Dimension> etc.

LYC's standard spherical roller bearing tolerance is according to GB/T307.1 <Rolling Bearing, Radial Bearing, and Tolerance>.

LYC's standard spherical roller bearing clearance is according to GB/T4604 <Rolling Bearing, and Radial Clearance >.

The dimension tolerance of LYC's standard spherical roller bearing is the normal grade P0 and the clearance is group 0. If customers have other special requirements on dimension, tolerance, and clearance, LYC have the ability to supply the corresponding products, including non-standard products.



Equivalent Dynamic Load

The equivalent dynamic load of the spherical roller bearing can be calculated from.

when $F_a/F_r \leq e$ $P = F_r + Y_1 F_a$

when $F_a/F_r > e$ $P = 0.67 F_r + Y_2 F_a$

where

P - Equivalent dynamic load, N

Y_1, Y_2 - Axial dynamic load coefficient, have already been listed in bearing dimension table.

Equivalent Static Load

The equivalent static load of spherical roller bearing can be calculated from

$$P_0 = F_r + Y_0 F_a$$

where

P_0 - Equivalent static load, N

Y_0 - Axial load static coefficient

Coefficient e , Y_0 , Y_1 and Y_2 are listed in bearing dimension table.

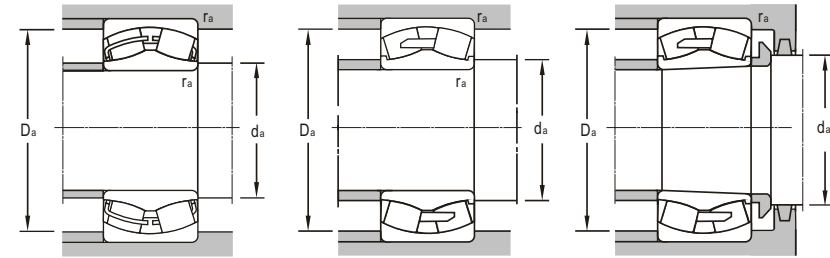
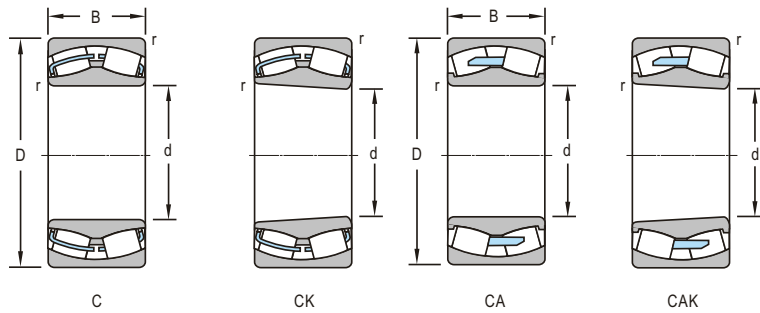

d 25~70mm

Boundary Dimensions				Basic Load Ratings		Limiting Speeds	
<i>d</i>	<i>D</i>	<i>B</i>	<i>r_{min}</i>	Dynamic <i>C</i>	Static <i>C₀</i>	Grease	Oil
mm				kN		r/min	
25	52	18	1	36.1	36.6	8500	11000
30	62	20	1	51.7	55	7500	9500
	68	20	1	51.7	55	7400	9400
35	72	23	1.1	68.9	72.5	6300	8000
40	80	23	1.1	86.9	93.9	6000	7500
	90	33	1.5	123	133	4500	5600
	90	33	1.5	121	129	4400	5500
45	85	23	1.1	86.7	101	5300	6700
	85	23	1.1	78.6	91.9	5200	6600
	100	36	1.5	141	154	3800	4800
50	90	23	1.1	90.3	97	5000	6300
	90	23	1.1	81.5	95.4	5000	6300
	110	40	2	176	193	3400	4300
	110	40	2	175	192	3300	4200
55	100	25	1.5	109	130	4500	5600
	100	25	1.5	109	130	4500	5600
	120	43	2	210	243	3200	4000
60	110	28	1.5	129	157	4000	5000
	130	46	2.1	246	288	2900	3800
	130	46	2.1	233	260	2900	3800
	130	46	2.1	233	274	2900	3800
65	120	31	1.5	144	178	3800	4800
	120	31	1.5	156	195	3800	4800
	140	33	2.1	203	242	3800	3600
	140	48	2.1	285	315	2600	3400
	140	48	2.1	285	315	2600	3400
70	125	31	1.5	163	207	3600	4500
	125	31	1.5	156	199	3500	4400
	150	35	2.1	216	276	2600	3400
	150	51	2.1	306	370	2400	3200
	150	51	2.1	311	352	2000	2800
	150	51	2.1	293	351	2000	2800

Bearing Designations				Mounting Dimensions			Calculation Factors				Mass
Cylindrical Bore	Present		Original Cylindrical Bore	<i>d_{amin}</i>	<i>D_{amax}</i>	<i>r_{amax}</i>	<i>e</i>	<i>Y₁</i>	<i>Y₂</i>	<i>Y₀</i>	kg
	Tapered Bore	Tapered Bore									
mm											
22205CA/W33	22205CAK/W33			31	46	1	0.36	1.9	2.8	1.8	0.178
22206C/W33	22206CK/W33			36	56	1	0.33	2	3	2	0.281
22206X1CN	22206X1CNK			36	62	1	0.33	2	3	2	0.369
22207/W33	22207K/W33	3507Y	113507Y	42	65	1	0.35	1.9	2.9	1.8	0.477
22208C/W33	22208CK/W33	35308Y	153508Y	47	73	1	0.28	2.4	3.6	2.5	0.575
22308C/W33	22308CK/W33	3509Y	113509Y	49	81	1.5	0.37	1.8	2.7	1.8	1.02
22308/W33	22308K/W33	3608Y	113608Y	49	81	1.5	0.42	1.6	2.4	1.6	1.05
22209C/W33	22209CK/W33	35309Y	153509Y	52	78	1	0.27	2.5	3.7	2.5	0.618
22209/W33	22209K/W33	3509Y	113509Y	52	78	1	0.3	2.3	3.4	2.2	0.617
22309C/W33	22309CK/W33			54	91	1.5	0.37	1.8	2.7	1.8	1.37
22210C/W33	22210CK/W33	35310Y	153510Y	57	83	1	0.25	2.7	4	2.7	0.65
22210CA/W33	22210CAK/W33			57	83	1	0.25	2.7	4	2.7	0.614
22310C/W33	22310CK/W33			64	91	2	0.38	1.7	2.6	1.7	1.83
22310/W33	22310K/W33	3610Y	113610Y	64	91	2	0.38	1.7	2.6	1.7	1.8
22211C/W33	22211CK/W33	35311Y	153511Y	66	88	1.5	0.25	2.7	4	2.7	0.88
22211CA/W33	22211CAK/W33			66	88	1.5	0.25	2.7	4	2.7	0.82
22311C/W33	22311CK/W33			66	109	2	0.37	1.8	2.7	1.8	2.38
22212C/W33	22212CK/W33	35312Y	153512Y	69	101	1.5	0.25	2.7	4	2.7	1.22
22312C/W33	22312CK/W33			72	118	2	0.36	1.9	2.8	1.8	2.95
22312/W33	22312K/W33	3612Y	113612Y	72	118	2	0.4	1.7	2.5	1.6	2.88
22312CA/W33	22312CAK/W33			72	118	2	0.37	1.8	2.7	1.8	2.96
22213C/W33	22213CK/W33	35313Y	153513Y	74	111	1.5	0.26	2.6	3.9	2.5	1.58
22213CA/W33	22213CAK/W33	35313HY	153513HY	74	111	1.5	0.27	2.5	3.7	2.5	1.52
21313		3313		77	128	2	0.25	2.7	4	2.7	2.58
22313/W33	22313K/W33			77	128	2	0.35	1.9	2.9	1.8	1.6
22313CA/W33	22313CAK/W33			77	128	2	0.35	1.9	2.9	1.8	3.54
22214C/W33	22214CK/W33	35314Y	153514Y	79	116	1.5	0.24	2.8	4.2	2.8	1.69
22214/W33	22214K/W33	3514Y	113514Y	79	116	1.5	0.27	2.5	3.7	2.5	1.64
21314		3314		82	138	2	0.25	2.7	4	2.7	3.01
22314C/W33	22314CK/W33	3614Y	153614Y	82	138	2	0.35	1.9	2.9	1.8	4.4
22314/W33	22314K/W33			82	138	2	0.37	1.8	2.7	1.8	4.21
22314CA/W33	22314CAK/W33			82	138	2	0.36	1.9	2.8	1.8	4.22

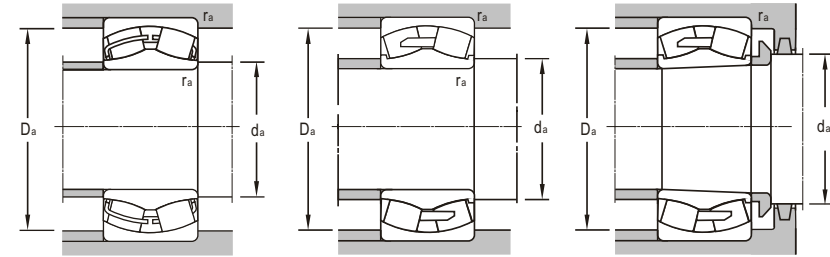
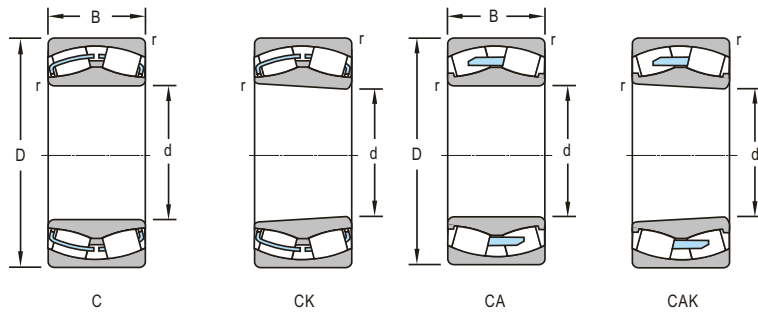

d 75~110mm

Boundary Dimensions				Basic Load Ratings		Limiting Speeds	
<i>d</i>	<i>D</i>	<i>B</i>	<i>r_{min}</i>	Dynamic <i>C</i>	Static <i>C₀</i>	Grease	Oil
mm				kN		r/min	
75	130	31	1.5	162	212	3400	4300
	130	31	1.5	155	211	3400	4300
	160	55	2.1	350	427	2200	3000
80	140	33	2	187	248	3200	4000
	140	33	2	186	252	3200	4000
	170	58	2.1	400	504	2000	2800
	170	58	2.1	388	446	2000	2800
85	150	36	2	204	262	3000	3800
	150	36	2	192	250	3000	3800
	180	60	3	392	498	1900	2600
	180	60	3	426	512	1900	2600
90	140	50	1.5	265	440	2700	3500
	160	40	2	257	340	2600	3400
	160	40	2	250	334	2600	3400
	160	52.4	2	305	434	1900	2600
	190	64	3	494	636	1800	2400
90	190	64	3	483	594	1800	2400
	190	64	3	475	583	1800	2400
	190	64	3	475	583	1800	2400
95	170	43	2.1	284	380	2400	3200
	200	67	3	509	637	1700	2200
	200	67	3	509	637	1700	2200
	200	67	3	517	617	1600	2100
100	180	46	2.1	331	441	2200	3000
	180	46	2.1	331	441	2100	2900
	180	46	2.1	314	416	2100	2900
	180	60.3	2.1	420	605	1700	2200
	215	73	3	543	698	1600	2100
	215	73	3	623	792	1700	2200
	215	73	3	614	785	1600	2100
	215	73	3	614	785	1600	2100
105	175	56	2	351	564	1900	2600
	175	56	2	351	564	1900	2600
110	170	45	2	293	465	2200	3000
	170	45	2	293	465	2200	3000

Bearing Designations				Mounting Dimensions			Calculation Factors				Mass
Present		Original		<i>d_{amin}</i>	<i>D_{amax}</i>	<i>r_{amax}</i>	<i>e</i>	<i>Y₁</i>	<i>Y₂</i>	<i>Y₀</i>	kg
Cylindrical Bore	Tapered Bore	Cylindrical Bore	Tapered Bore								
22215C/W33	22215 CK/W	53515Y	153515Y	84	121	1.5	0.22	3	4.5	2.9	1.73
22215/W33	22215K/W33	3515Y	113515Y	84	121	1.5	0.26	2.6	3.9	2.5	1.75
22315C/W33	22315CK/W33			87	148	2	0.35	1.9	2.9	1.8	5.4
22216C/W33	22216CK/W33	53516Y	15316Y	90	130	2	0.22	3	4.5	2.9	2.23
22216/W33	22216K/W33	3516Y	113516Y	90	130	2	0.25	2.7	4	2.7	2.23
22316C/W33	22316CK/W33	53616Y	153616Y	92	158	2	0.34	2	2.9	1.9	6.59
22316/W33	22316K/W33	3616Y	113616Y	92	158	2	0.37	1.8	2.7	1.8	6.19
22217C/W33	22217CK/W33	53517Y	153517Y	95	140	2	0.23	2.9	4.4	2.8	2.8
22217/W33	22217K/W33	3517Y	113517Y	95	140	2	0.26	2.6	3.9	2.5	2.79
22317MA/W33/C4				99	166	2.5	0.33	2	3	2	7.59
22317/W33	22317K/W33	3617Y	113617Y	99	166	2.5	0.37	1.8	2.7	1.8	7.07
24018C	24018CK			100	130	1.5	0.32	2.1	3.1	2	2.97
22218C/W33	22218CK/W33	53518Y	153518Y	101	149	2	0.23	2.9	4.4	2.8	3.24
22218/W33	22218K/W33	3518Y	113518Y	101	149	2	0.27	2.5	3.7	2.5	3.11
23218C/W33	23218CK/W33	3053218Y	3153218Y	101	149	2	0.31	2.2	3.3	2.2	4.61
22318C/W33	22318CK/W33	53618Y	153618Y	104	176	2.5	0.34	2	2.9	1.9	9.12
22318CA/W33	22318CAK/W33	53618HY	153618HY	104	176	2.5	0.35	1.9	2.9	1.8	8.72
22318/W33	22318K/W33	3618Y	113618Y	104	176	2.5	0.37	1.8	2.7	1.8	8.6
22219C/W33	22219CK/W33			107	158	2	0.24	2.8	4.2	2.8	4.2
22319CA/W33	22319CAK/W33			109	186	2.5	0.35	1.9	2.9	1.8	9.95
22319ZMA/W33/C4				109	186	2.5	0.33	2	3	2	10.3
22319/W33	22319K/W33	3619Y	113619Y	109	186	2.5	0.38	1.7	2.6	1.7	9.93
22220C/W33	22220CK/W33	53520Y	153520Y	112	168	2	0.24	2.8	4.2	2.8	4.95
22220CA/W33	22220CAK/W33			112	168	2	0.24	2.8	4.2	2.8	4.97
22220/W33	22220K/W33	3520Y	113520Y	112	168	2	0.27	2.5	3.7	2.5	5.03
23220C/W33	23220CK/W33	3053220Y	3153220Y	112	168	2	0.33	2	3	2	6.71
22320CA/W33				114	201	2.5	0.35	2.9	1.8	1.8	13.2
22320C/W33	22320CK/W33	53620Y	153620Y	114	201	2.5	0.36	1.9	2.8	1.8	13.6
22320CA/W33	22320CAK/W33	53620HY	153620HY	114	201	2.5	0.35	1.9	2.9	1.8	12.4
22320/W33	22320K/W33	3620Y	113620Y	114	201	2.5	0.37	1.8	2.7	1.8	13
23121/W33	23121K/W33	3003721Y	3113721Y	115	165	2	0.32	2.1	3.1	2	6.64
23121N		3203721		115	165	2	0.32	2.1	3.1	2	6.59
23022/W33	23022 K/W33	3003122 Y	3113122 Y	120	160	2	0.26	2.6	3.9	2.5	4.2
23022N		3203122		120	160	2	0.26	2.6	3.9	2.5	4.18

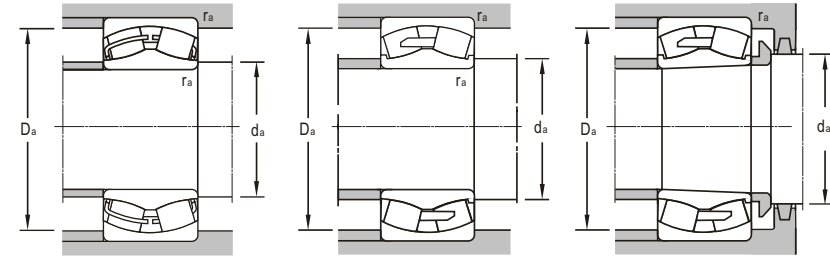
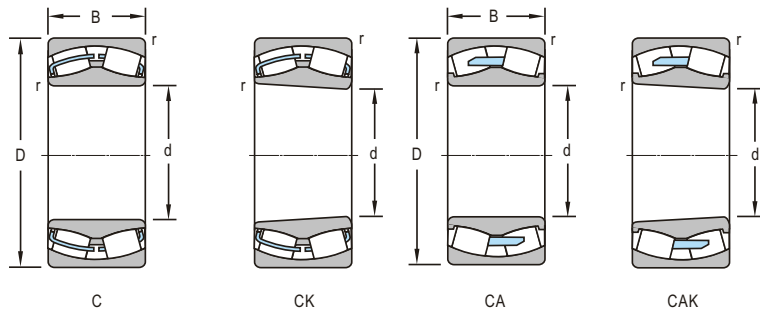

d 110~130mm

Boundary Dimensions				Basic Load Ratings		Limiting Speeds		
d	D	B	r _{min}	Dynamic C	Static C ₀	Grease	Oil	
mm				kN		r/min		
110	170	60	2	359	605	1700	2500	
	170	60	2	359	605	1700	2500	
	180	56	2	365	562	1900	2600	
	180	56	2	365	562	1900	2600	
	180	69	2	483	754	1600	2000	
	180	69	2	435	721	1500	1800	
	200	53	2.1	426	588	2000	2800	
	200	53	2.1	366	531	1900	2700	
	200	69.8	2.1	515	760	1600	2000	
	240	80	3	629	795	1600	2000	
	240	80	3	728	963	1600	2000	
	240	80	3	739	982	1600	2000	
	240	80	3	750	915	1500	1900	
	240	92.1	3	799	998	1400	1700	
120	180	46	2	315	527	1800	2500	
	180	46	2	315	527	1800	2500	
	180	60	2	395	686	1500	2000	
	180	60	2	395	686	1600	2000	
	200	62	2	410	660	1700	2300	
	200	62	2	410	660	1700	2300	
	200	80	2	561	919	1300	1700	
	200	80	3	561	919	1300	1700	
	200	80	2	589	949	1400	1800	
	215	58	2.1	495	689	1900	2600	
	215	58	2.1	489	656	1800	2500	
	215	76	2.1	595	910	1500	1900	
	260	86	3	746	954	1400	1800	
	260	86	3	842	1110	1400	1800	
	130	200	52	2	400	655	1700	2300
		200	52	2	400	655	1700	2300
210		64	2	499	777	1600	2200	
210		80	2	581	982	1300	1700	
210		80	2	581	982	1300	1700	
210		80	2	633	1070	1300	1700	
230		64	3	582	830	1800	2400	
230		64	3	552	786	1700	2300	
230		64	3	564	800	1700	2300	
230		80	3	700	1080	1300	1700	
280		93	4	930	1250	1300	1700	

Bearing Designations				Mounting Dimensions			Calculation Factors				Mass
Cylindrical Bore	Present	Tapered Bore	Original	D _{amin}	D _{amax}	r _{amax}	e	Y ₁	Y ₂	Y ₀	kg
	Cylindrical Bore		Tapered Bore								
24022CG/W33CA52				119	161	2	0.33	2	3	2	5.14
24022C	24022CK30			120	160	2	0.32	2.1	3.1	2	5.18
23122/W33	23122 K/W33	3003722Y	3113722Y	120	170	2	0.32	2.1	3.1	2	6.25
23122N		4053722Y	4453722Y	120	170	2	0.32	2.1	3.1	2	6.2
24122C/W33	24122K30/W33	4053722Y	4453722Y	120	170	2	0.35	1.9	2.9	1.8	6.88
24122CA/W33	24122CAK30/W33			120	170	2	0.36	1.9	2.8	1.8	6.86
22222C/W33	22222CK/W33	53522Y	153522Y	122	188	2	0.25	2.7	4	2.7	7.25
22222/W33	22222K/W33	3522Y	113522Y	122	188	2	0.28	2.4	3.6	2.5	7.37
23222C/W33	23222 CK/W33	3053222Y	3153222Y	122	188	2	0.35	1.9	2.9	1.8	9.66
22322 ZMA/W33				124	226	2.5	0.33	2	3	2	18
22322CA/C3W33YA				124	226	2.5	0.35		2.9	1.8	17.7
22322CA/W33	22322CAK/W33	53622HY	153622HY	124	226	2.5	0.35	1.9	2.9	1.8	17.5
22322/W33	22322K/W33	3622Y	113622Y	124	226	2.5	0.37	1.8	2.7	1.8	18
23322/W33	23322K/W33	3003322Y	3113322Y	124	226	2.5	0.44	1.5	2.3	1.5	23.6
23024/W33	23024K/W33	3003124Y	4453124HY	130	170	2	0.25	2.7	4	2.7	4.63
23024N		3203124		130	170	2	0.25	2.7	4	2.7	4.61
24024CA/W33	24024CAK30/W33			130	170	2	0.3	2.3	3.4	2.2	5.41
24024C/W33		4053124Y		130	170	2	0.3	2.3	3.4	2.2	5.41
23124/W33	23124K/W33	3003724Y	3113724Y	130	190	2	0.32	2.1	3.1	2	7.61
23124N		3203724		130	190	2	0.32	2.1	3.1	2	7.57
24124CA/W33	24124CAK30/W33			130	190	2	0.38	1.7	2.6	1.7	10
24124CA/C3/YB				131	189	2	0.37	1.8	2.7	1.8	10
24124C/W33	24124CK30/W33	4053724Y	4453724Y	130	190	2	0.38	1.7	2.6	1.7	10
22224C/W33	22224CK/W33	53524Y	153524Y	132	203	2	0.25	2.7	4	2.7	9.08
22224/W33	22224K/W33	3524Y	113524Y	132	203	2	0.28	2.4	3.6	2.5	9.13
23224C/W33	23224CK/W33	3053224Y	3153224Y	132	203	2	0.35	1.9	2.9	1.8	12
22324 ZMA/W33				134	246	2.5	0.35	1.9	2.9	1.8	22.6
22324C/W33	22324CK/W33	53624Y	53624HY	134	246	2.5	0.4	1.7	2.5	1.6	22.7
23026/W33	23026K/W33	3003126Y	3113126Y	140	190	2	0.26	2.6	3.9	2.5	6.8
23026N		3203126		140	190	2	0.26	2.6	3.9	2.5	6.72
23126CA/W33	23126CAK30/W33			140	200	2	0.36	1.9	2.8	1.8	9.55
24126 CA/C3W33				141	199	2	0.35		2.9	1.8	10.8
24126 CA/W33				141	199	2	0.35		2.9	1.8	10.8
24126C/W33	24126CAK30/W34	4053726Y	4453726Y	140	200	2	0.36	1.9	2.8	1.8	10.9
22226C/W33	22226CK/W33	53526Y	153626Y	144	216	2.5	0.35	1.9	2.9	1.8	11.7
22226CA/W33	22226CAK/W33			144	216	2.5	0.27	2.5	3.7	2.5	11.4
22226/W33	22226K/W33	3526Y	113526Y	144	216	2.5	0.29	2.4	3.5	2.3	11.1
23226C/W33	23226K/W33	3053226Y	3153226Y	144	216	2.5	0.33	2	3	2	14.4
22326CA/W33	22326CAK/W33	53626HY	153626HY	148	262	3	0.35	1.9	2.9	1.8	27.1

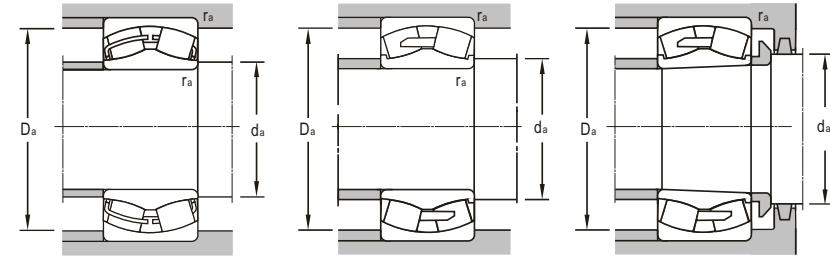
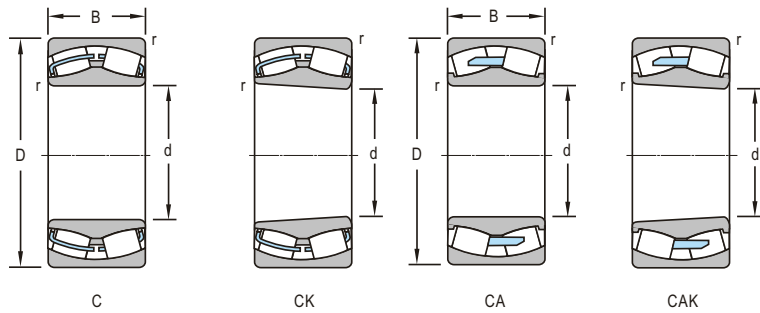

d 130~160mm

Boundary Dimensions				Basic Load Ratings		Limiting Speeds	
<i>d</i>	<i>D</i>	<i>B</i>	<i>r_{min}</i>	Dynamic <i>C</i>	Static <i>C₀</i>	Grease	Oil
mm				kN		r/min	
130	280	93	4	836	1090	1200	1600
	280	93	4	836	1090	1300	1700
140	210	53	2	395	705	1600	2100
	210	53	2	395	705	1600	2100
	210	69	2	530	910	1400	1800
	225	68	2.1	560	925	1500	1800
	225	85	2.1	620	1060	1100	1500
	225	85	2.1	649	1120	1100	1500
	250	68	3	642	931	1700	2200
	250	68	3	636	897	1500	1900
	250	68	3	662	905	1500	1900
	250	88	3	835	1300	1200	1600
	300	102	4	978	1290	1100	1500
	300	102	4	1120	1550	1100	1500
300	102	4	1100	1420	1100	1500	
150	225	56	2.1	407	725	1500	1900
	225	75	2.1	580	1060	1450	1850
	250	80	2.1	683	1170	1300	1600
	250	100	2.1	951	1570	1000	1400
	250	100	2.1	861	1420	900	1300
	270	73	3	749	1050	1600	2000
	270	73	3	736	1030	1500	1900
	270	96	3	907	1350	1100	1500
	320	108	4	1140	1580	1000	1400
	320	108	4	1210	1660	1000	1400
	320	108	4	1210	1660	1000	1400
	320	108	4	1220	1680	1000	1400
160	240	60	2.1	495	875	1500	1900
	240	60	2.1	495	875	1500	1900
	240	80	2.1	660	1220	1100	1500
	240	80	2.1	628	1140	1100	1500
	270	86	2.1	820	1200	1200	1600
	270	86	2.1	833	1290	1200	1600
	270	109	2.1	1070	1750	950	1300
	270	109	2.1	958	1590	900	1200
	290	80	3	850	1230	1400	1800
	290	80	3	876	1230	1350	1700
	290	104	3	1020	1550	900	1300

Bearing Designations				Mounting Dimensions			Calculation Factors				Mass
Cylindrical Bore	Present Tapered Bore	Original Cylindrical Bore	Tapered Bore	<i>d_{amin}</i>	<i>D_{amax}</i>	<i>r_{amax}</i>	<i>e</i>	<i>Y₁</i>	<i>Y₂</i>	<i>Y₀</i>	kg
22326ZMB				148	262	3	0.35	1.9	2.9	1.8	28.6
22326 ZMA/W33				147	263	3	0.35	1.9	2.9	1.8	29.1
23028/W33	23028K/W33	3003128Y	3113128Y	150	200	2	0.24	2.8	4.2	2.8	7.65
23028H		3203128		150	200	2	0.24	2.8	4.2	2.8	7.64
24028C/W33	24028CK30/W33	4053128Y	4153128Y	150	200	2	0.28	2.4	3.6	2.5	8.09
23128CA/W33	23128CAK/W33	3053728HY	3153728HY	152	213	2	0.28	2.4	3.6	2.5	10.4
24128CA/W33	24128CAK30/W33			152	213	2	0.35	1.9	2.9	1.8	12.9
24128 CC/W33/C4				152	213	2	0.35	1.9	2.9	1.8	13
22228C/W33	22228CK/W33	53528Y	153528Y	154	236	2.5	0.26	2.6	3.9	2.5	14.2
22228CA/W33	22228CAK/W33	53528HY	153528HY	154	236	2.5	0.26	2.6	3.9	2.5	14.1
22228/W33	22228K/W33	3528Y	113528Y	154	236	2.5	0.29	2.4	3.5	2.3	14.5
23228C/W33	23228CK/W33	3053228Y	3153228Y	154	236	2.5	0.35	1.9	2.9	1.8	18.8
22328 ZMA/W33				157	283	3	0.35	1.9	2.9	1.8	36.3
22328CA/W33	22328CAK/W33	53628HY	153628HY	158	282	3	0.35	1.9	2.9	1.8	35.9
22328/W33	22328K/W33	3628Y	113628Y	158	282	3	0.38	1.7	2.6	1.7	36.9
23030/W33	23030K/W33	3003130Y	3113130Y	162	213	2	0.25	2.7	4	2.7	8.85
24030CC/W33C4S2				161	214	2	0.3	2.3	3.4	2.2	10.4
23130CA/W33	23130CAK/W33	3053730HY	3153730HY	162	238	2	0.3	2.3	3.4	2.2	18.2
24130C/W33	24130CK30/W33	4053730Y	4453730Y	162	238	2	0.37	1.8	2.7	1.8	20.3
24130CA/W33	24130CAK30/W33			162	238	2	0.38	1.7	2.6	1.7	19.5
22230C/W33	22230CK/W33	53530Y	153530Y	164	256	2.5	0.27	2.5	3.7	2.5	17.9
22230/W33	22230K/W33	3530Y	113530Y	164	256	2.5	0.29	2.4	3.5	2.3	17.5
23230C/W33	23230CK/W33	3053230Y	3153230Y	164	256	2.5	0.35	1.9	2.9	1.8	24.3
22330 ZMA/W33				167	303	3	0.35	1.9	2.9	1.8	44.5
22330CA/C3W33YA				167	303	3	0.35	1.9	2.9	1.8	42.5
22330/W33	22330K/W33	3630Y	113630Y	168	302	3	0.38	1.7	2.6	1.7	42
22330CA/W33	22330CAK/W33	53630HY	153630HY	168	302	3	0.35	1.9	2.9	1.8	41.7
23032N		3203132		172	228	2	0.25	2.7	4	2.7	13.4
23032/W33	23032K/W33	3003132Y	3113132Y	172	228	2	0.25	2.7	4	2.7	13.4
24032C/W33	24032CK30/W33	4053132Y	4453132Y	172	228	2	0.3	2.3	3.4	2.2	12.8
24032 CA/W33				171	229	2	0.3	2.3	3.4	2.2	12.8
23132	23132K			172	258	2	0.32	2.1	3.1	2	20.8
23132CA/W33	23132CAK/W33	3053732HY	3153732HY	172	258	2	0.31	2.2	3.3	2.2	20.3
24132C/W33	24132CK30/W33	4053732Y	4453732HY	172	258	2	0.38	1.7	2.6	1.7	19.5
24132CA/W33				172	258	2	0.38	1.7	2.6	1.7	25.3
22232CA/W33	22232CAK/W33	53532HY	153532HY	174	276	2.5	0.27	2.5	3.7	2.5	22.6
22232/W33	22232K/W33	3532Y	113532Y	174	276	2.5	0.3	2.3	3.4	2.2	22.3
23232CA	23232CAK			174	276	2.5	0.35	1.9	2.9	1.8	29.8

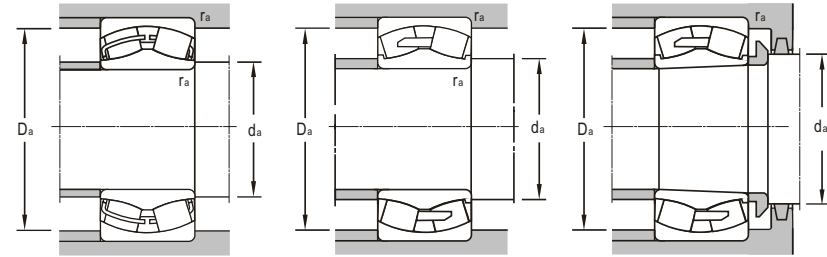
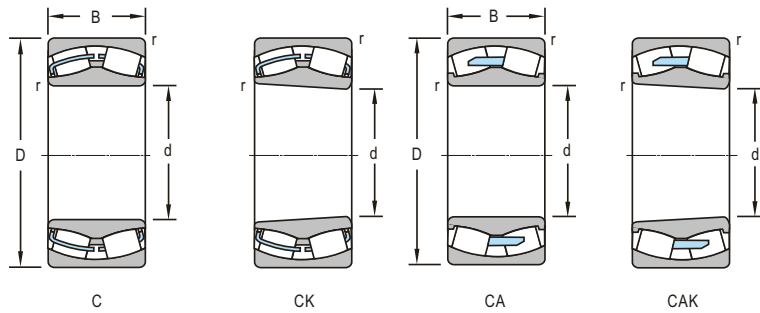

d 160~200mm

Boundary Dimensions				Basic Load Ratings		Limiting Speeds		
<i>d</i>	<i>D</i>	<i>B</i>	<i>r_{min}</i>	Dynamic <i>C</i>	Static <i>C₀</i>	Grease	Oil	
mm				kN		r/min		
160	340	114	4	1340	1840	930	1200	
	340	114	4	1140	1580	930	1200	
170	260	67	2.1	640	1040	1400	1800	
	260	67	2.1	640	1040	1400	1800	
	260	90	2.1	778	1310	1000	1400	
	310	86	4	981	1390	1200	1600	
	310	110	4	1200	1900	950	1300	
	360	120	4	1500	2140	930	1200	
180	280	74	2.1	710	1210	1300	1600	
	280	100	2.1	930	1610	900	1200	
	280	100	2.1	917	1710	900	1200	
	300	96	3	1060	1800	1100	1500	
	300	96	3	987	1720	1000	1400	
	300	96	3	987	1720	1000	1400	
	300	96	3	987	1720	1000	1400	
	300	118	3	1170	1930	900	1200	
	320	86	4	995	1510	1200	1600	
	320	112	4	1310	2090	900	1200	
	320	112	4	1310	2090	900	1200	
	380	126	4	1650	2330	900	1200	
	190	280	67	2.1	633	1120	1200	1500
		290	75	2.1	800	1500	1200	1500
290		100	2.1	938	1690	950	1300	
320		104	3	1050	1760	950	1300	
320		104	3	1140	1960	950	1300	
320		128	3	1290	2250	850	1100	
340		92	4	1140	1730	1000	1600	
340		92	4	1090	1640	1200	1600	
340		120	4	1490	2380	850	1100	
400		132	5	1850	2590	850	1100	
200		310	82	2.1	870	1510	1100	1400
		340	112	3	1230	2240	850	1200
	340	140	3	1530	2620	800	1000	
	340	140	3	1530	2620	800	1000	
	340	140	3	1660	2810	800	1000	
	360	98	4	1210	1870	1100	1500	
	360	128	4	1490	2370	800	1000	

Bearing Designations				Mounting Dimensions			Calculation Factors				Mass	
Cylindrical Bore	Present	Tapered Bore	Original	<i>d_{amin}</i>	<i>D_{amax}</i>	<i>r_{amax}</i>	<i>e</i>	<i>Y₁</i>	<i>Y₂</i>	<i>Y₀</i>	kg	
	Cylindrical Bore		Tapered Bore									
22332/W33		22332K/W33	3632Y	113632Y	178	322	3	0.38	1.7	2.6	1.7	50.3
22332MA/W33/CA					177	323	3	0.35	1.9	2.9	1.8	53.3
23034N			3203134		182	248	2	0.26	2.6	3.9	2.5	14.6
23034/W33		23034 K/W33	3003134 Y	3113134	182	248	2	0.26	2.6	3.9	2.5	14.6
24034C/W33		24034CK30/W33	4003134Y	4113134Y	182	248	2	0.33	2	3	2	19.3
22234/W33		22234K/W33	3534Y	113534Y	188	292	3	0.3	2.3	3.4	2.2	27.6
23234CA/W33		23234CAK/W33	3053234HY	3153234HY	188	292	3	0.35	1.9	2.9	1.8	37.1
22334/W33		22334K/W33	3634Y	113634Y	188	342	3	0.37	1.8	2.7	1.8	59.3
23036/W33		23036K/W33	3003136Y	3113136Y	192	268	2	0.26	2.6	3.9	2.5	19.3
24036/W33		24036K30/W33	4003136Y	4403136Y	192	268	2	0.35	1.9	2.9	1.8	22.3
24036CP69 W33					191	269	2	0.33	2	3	2	22.7
23136C/W33		23136CK/W33			194	286	2.5	0.3	2.3	3.4	2.2	27.2
23136/W33		23136K/W33	3003736 Y	3113736Y	194	286	2.5	0.32	2.1	3.1	2	26.8
23136/W33YA2			3003736KY		194	286	2.5	0.32	2.1	3.1	2	26.8
23136 N			3203736		194	286	2.5	0.32	2.1	3.1	2	26.4
24136/W33		24136K30/W33			194	286	2.5	0.38	1.7	2.6	1.7	33.7
22236/W33		22236K/W33	3536Y	113536Y	198	302	3	0.28	2.4	3.6	2.5	29.3
23236CA/W33		23236CAK/W33	3053236HY	3153236HY	198	302	3	0.35	1.9	2.9	1.8	39.5
23236CA/W33YA2			3053236HKY		198	302	3	0.35	1.9	2.9	1.8	39.4
22336/W33		22336K/W33	3636Y	113636Y	198	362	3	0.35	1.9	2.9	1.8	80.7
2638			3738		202	270	2	0.23	2.9	4.4	2.8	13.7
23038/W33		23038 K/W33	3003138 Y	3113138Y	202	278	2	0.26	2.6	3.9	2.5	20.3
24038C/W33		24038CK30/W33	4003138Y	4113138Y	202	278	2	0.31	2.2	3.3	2.2	23.9
23138/W33		23138K/W33			204	306	2.5	0.33	2	3	2	35.1
23138CA/W33		23138CAK/W33			204	306	2.5	0.31	2.2	3.3	2.2	45
24138CA		24138CAK30/W33			204	306	2.5	0.4	1.7	2.5	1.6	43.8
22238CA/W33		22238 CAK/W33	53538HY	153538HY	208	322	3	0.26	2.6	3.9	2.5	35.5
22238/W33		22238K/W33	3538Y	113538Y	208	322	3	0.29	2.4	3.5	2.3	35.5
23238CA/W33		23238CAK/W33	3053238HY	3153238HY	208	322	3	0.35	1.9	2.9	1.8	51
22338/W33		22338K/W33	3638Y	113638Y	210	380	4	0.25	2.7	4	2.7	79.7
23040/W33		23040 K/W33	3003140Y	3113140Y	212	298	2	0.26	2.6	3.9	2.5	26
23140/W33		23140 K/W33	3003740Y	3113740Y	214	326	2.5	0.34	2	2.9	1.9	50.5
24140CA/W33					214	326	2.5	0.4	2.5	1.6		52.3
24140CA/C3/W33					214	326	2.5	0.4	2.5	1.6		52.3
24140C/W33		24140CK30/W33	4053740Y	4453740Y	214	326	2.5	0.4	1.7	2.5	1.6	51.9
22240/W33		22240K/W33	3540Y	113540Y	218	342	3	0.29	2.4	3.5	2.3	44.7
23240/W33		23240K/W33			218	342	3	0.36	1.9	2.8	1.8	56.8

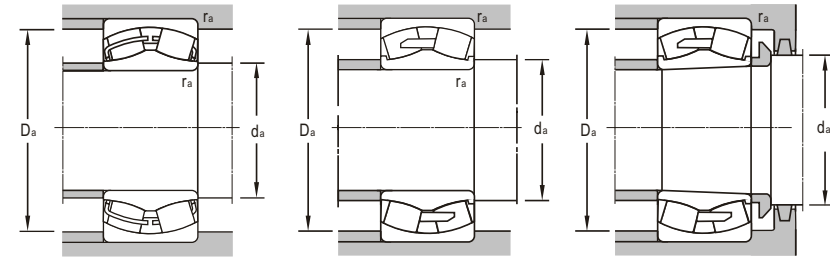
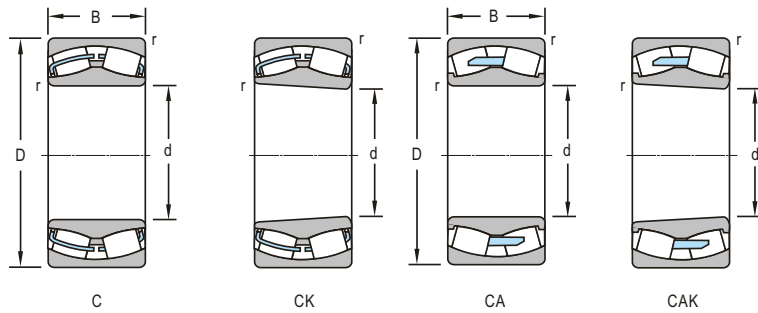

d 200 ~ 280mm

Boundary Dimensions				Basic Load Ratings		Limiting Speeds	
<i>d</i>	<i>D</i>	<i>B</i>	<i>r_{min}</i>	Dynamic <i>C</i>	Static <i>C₀</i>	Grease	Oil
mm				kN		r/min	
200	420	138	5	1900	2800	850	1100
220	320	76	3	758	1280	1000	1300
	340	90	3	1100	1750	1100	1500
	370	120	4	1530	2640	900	1200
	370	120	4	1540	2650	850	1100
	370	150	4	1870	3350	750	950
	400	108	4	1570	2430	950	1300
	400	108	4	1570	2430	950	1300
	400	144	4	1860	3100	750	950
460	145	5	2130	3170	750	950	
240	320	60	2.1	579	1220	1000	1400
	360	92	3	1160	1870	1000	1400
	360	118	3	1320	2610	800	1000
	400	128	4	1870	3000	850	1100
	400	128	4	1800	2950	850	1100
	400	160	4	1980	3710	670	850
	440	120	4	1720	2700	900	1200
	440	160	4	2280	3870	670	850
500	155	5	2400	3600	670	850	
250	365	87	3	956	1870	880	1100
260	360	75	2.1	883	1760	1000	1300
	400	104	4	1440	2570	900	1200
	400	140	4	1700	3260	700	900
	400	140	4	1700	3260	700	900
	440	144	4	2290	3510	800	1000
	440	144	4	2550	3900	800	1000
	440	180	4	2500	4560	720	900
	440	180	4	2470	4320	600	750
	440	180	4	2350	4320	600	750
	480	130	5	2160	3100	850	1100
	480	174	5	2800	4100	560	720
490	153	4	2420	3940	760	1050	
540	165	6	2860	4430	560	720	
280	380	75	2.1	911	1860	900	1200
	420	106	4	1560	2560	850	1100
	420	106	4	1540	2950	800	1000

Bearing Designations				Mounting Dimensions			Calculation Factors				Mass
Cylindrical Bore	Present Tapered Bore	Original Cylindrical Bore	Original Tapered Bore	<i>d_{amin}</i>	<i>D_{amax}</i>	<i>r_{amax}</i>	<i>e</i>	<i>Y₁</i>	<i>Y₂</i>	<i>Y₀</i>	kg
22340/W33	22340K/W33	3640Y	113640Y	222	398	4	0.37	1.8	2.7	1.8	93.5
2644		3844		232	308	2.5	0.23	2.9	4.4	2.8	21.6
23044/W33	23044K/W33	3003744Y	3113744Y	233	327	2.5	0.26	2.6	3.9	2.5	30.8
23144/W33	23144K/W33	3003744Y	3113744Y	237	353	3	0.32	2.1	3.1	2	53.5
23144CA/W33	23144CAK/W33	4053744Y	4453744Y	237	353	3	0.32	2.1	3.1	2	54.2
24144/W33	24144CK30/W33	3544Y	113544Y	237	353	3	0.4	1.7	2.5	1.6	66.1
22244/W33	22244K/W33	3544Y	113544Y	237	383	3	0.29	2.4	3.5	2.3	62.4
22244CA/W33	22244CAK/W33	3644Y	113644Y	237	383	3	0.27	2.5	3.7	2.5	62.4
23244/W33	23244 K/W33	3003244Y	3113244Y	237	383	3	0.38	1.8	2.6	1.7	94.2
22344/W33	22344K/W33	3644Y	113644Y	240	440	4	0.35	1.9	2.9	1.8	130
23948CA/W33				251	309	2	0.15	4.5	6.7	4.5	13.4
23048/W33	23048 K/W33	3003148Y	3113148Y	253	347	2.5	0.25	2.7	4	2.7	37.4
24048CA/W33	24048CAK30/W33	3003148Y	3113148Y	253	347	2.5	0.3	2.3	3.4	2.2	42.4
23148/W33	23148K/W33	3003748Y	3113748Y	257	383	3	0.33	2	3	2	75.2
23148CA/W33	23148CAK/W33	3003748Y	3113748Y	257	383	3	0.3	2.3	3.4	2.2	65
24148/W33	24148K30/W33	4003748Y	4403748Y	257	383	3	0.41	1.7	2.5	1.6	81.6
22248/W33	22248K/W33	3548Y	113548Y	257	423	3	0.29	2.4	3.5	2.3	85
23248/W33	23248K/W33	3003248Y	3113248Y	257	423	3	0.37	1.8	2.7	1.8	109
22348/W33	22348K/W33	3648Y	113648Y	260	480	4	0.35	1.9	2.9	1.8	154
2650		3750		264	351	2.5	0.22	3	4.5	2.9	32.2
23952CA/W33				271	349	2	0.18	3.8	5.6	3.6	23.7
23052/W33	23052K/W33	3003152Y	3113152Y	275	385	3	0.26	2.6	3.9	2.5	51.2
24052CA/W33	24052CAK30/W33	3003152Y	3113152Y	275	385	3	0.33	2	3	2	63.4
24052CA/C9W33		3003752Y	3113752Y	275	385	3	0.33	2	3	2	63.3
23152/W33	23152K/W33	3003752Y	3113752Y	277	423	3	0.33	2	3	2	96
23152/S1				277	423	3	0.31	2.2	2.3	2.2	96
24152/W33	24152K30/W33	4053752Y	4453752Y	277	423	3	0.42	1.6	2.4	1.6	112
24152CA/W33	24152CAK30/W33	4053752Y	4453752Y	277	423	3	0.4	1.7	2.5	1.6	108
24152C/W33	24152CK30/W33	53552HY	153552HY	277	423	3	0.4	1.7	2.5	1.6	113
22252CA/W33	22252CAK/W33	53552HY	153552HY	280	460	4	0.27	2.5	3.7	2.5	105
23252CA/W33	23252CAK/W33	3053252HY	3153252HY	280	460	4	0.37	1.8	2.7	1.8	151
2652		3752		280	460	4	0.33	2	3	2	140
22352/W33	22352K/W33	3652Y	113652Y	286	514	5	0.34	2	2.9	1.9	193
23956CA/W33				291	369	2	0.16	4.2	6.3	4	25
23056/W33	23056K/W33	3003156Y	3113156Y	295	405	3	0.25	2.7	4	2.7	61.5
23056CA/W33	23056CAK/W33	3003156Y	3113156Y	295	405	3	0.23	2.9	4.4	2.8	51.7

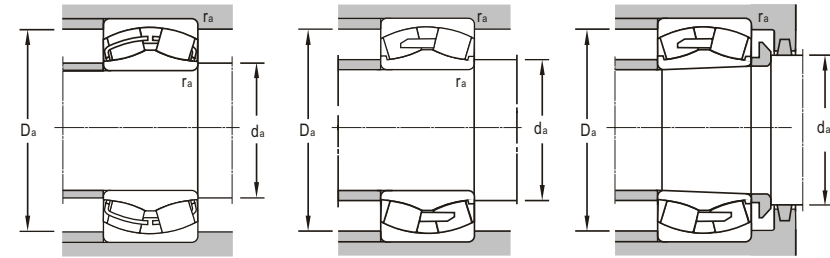
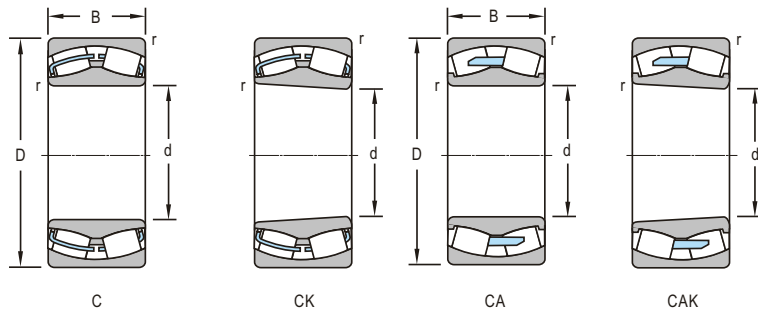

d 280~360mm

Boundary Dimensions				Basic Load Ratings		Limiting Speeds	
d	D	B	r _{min}	Dynamic C	Static C ₀	Grease	Oil
mm				kN		r/min	
280	420	140	4	1780	3500	670	850
	460	146	5	2070	3960	750	950
	460	146	5	2380	3880	750	950
	460	180	5	2360	4420	560	700
	460	180	5	2400	4500	560	700
	460	180	5	2400	4590	560	700
	500	130	5	2110	3370	800	1000
	500	176	5	2560	4350	600	750
	500	180	5	2360	4420	600	750
	580	175	6	3180	4970	600	750
300	420	90	3	1260	2460	950	1300
	460	118	4	1910	3170	720	920
	460	118	4	2090	3370	800	1000
	460	160	4	2430	4490	600	750
	500	160	5	2580	4590	670	850
	500	160	5	2700	4920	650	850
	500	160	5	2880	4640	670	850
	500	200	5	3380	5940	530	670
	500	200	5	3120	5650	500	600
	500	200	5	3180	6100	450	550
	540	140	5	2480	3820	700	900
	320	440	90	3	1290	2430	900
480		121	4	1850	3450	720	900
480		121	4	2020	3580	800	1000
480		160	4	2570	5060	680	850
540		176	5	3390	5538	630	800
540		218	5	3470	6430	480	600
580		208	5	3500	6360	500	630
580		218	5	3470	6430	460	580
340	460	90	3	1310	2520	880	1180
	520	133	5	2430	4350	680	880
	520	180	5	2920	5580	510	650
	520	180	5	3110	5710	520	660
	580	190	5	3830	6240	600	750
	580	243	5	4180	7720	450	560
360	480	90	3	1330	2710	850	1100
	540	134	5	2480	4500	670	850

Bearing Designations				Mounting Dimensions			Calculation Factors				Mass
Cylindrical Bore	Present	Tapered Bore	Original	d _{amin}	D _{amax}	r _{amax}	e	Y ₁	Y ₂	Y ₀	kg
	Cylindrical Bore		Tapered Bore								
24056CA/W33		24056CAK30/W33		295	405	3	0.3	2.3	3.4	2.2	71.3
23156/W33		23156K/W33	3003756Y	300	440	4	0.32	2.1	3.1	2	95
23156CA/W33		23156CAK/W33		300	440	4	0.31	2.2	3.3	2.2	96.2
24156 CA				300	440	4	0.37	1.8	2.7	1.8	119
24156 CA/YA				300	440	4	0.37	1.8	2.7	1.8	157
24156/W33		24156K30/W33		300	440	4	0.37	1.8	2.7	1.8	119
22256/W33		22256K/W33	3556Y	300	480	4	0.28	2.4	3.6	2.5	124
23256/W33		23256 K/W33	3003256Y	300	480	4	0.37	1.8	2.7	1.8	152
24156/W33/YA1				300	480	4	0.37	1.8	2.7	1.8	158
22356/W33		22356K/W33	3656Y	306	554	5	0.34	2	2.9	1.9	238
23960C/W33		23960CK/W33		313	407	2.5	0.19	3.6	5.3	3.5	39.5
23060/W33		23060K/W33	3003160Y	315	445	3	0.26	2.6	3.9	2.5	74.6
23060CA/W33		23060CAK/W33		315	445	3	0.24	2.8	4.2	2.8	76.6
24060CA/W33		24060CAK30/W33	4053160Y	315	445	3	0.32	2.1	3.1	2	101
23160/W33		23160K/W33	3003760Y	320	480	4	0.32	2.1	3.1	2	133
23160CC/C3/W33				320	480	4	0.3	2.3	3.4	2.2	127
23160CA/W33		23160CAK/W33		320	480	4	0.31	2.2	3.3	2.2	127
24160C/W33		24160CK30/W33	4053760Y	320	480	4	0.37	1.8	2.7	1.8	159
24160CA/W33		24160CAK30/W33		320	480	4	0.36	1.9	2.8	1.8	160
24160/W33		24160K30/W33	3003264Y	320	480	4	0.39	1.7	2.6	1.7	159
22260/W33		22260K/W33	3560Y	320	520	4	0.28	2.4	3.6	2.5	143
23964/W33		23964K/W33	3003964Y	333	427	2.5	0.19	3.6	5.3	3.5	45.1
23064/W33		23064K/W33	3003164Y	335	465	3	0.26	2.6	3.9	2.5	80.9
23064CA/W33		23064CAK/W33		335	465	3	0.24	2.8	4.2	2.8	77.4
24064/W33		24064K30/W33	4003164Y	335	465	3	0.32	2.1	3.1	2	103
23164CA/W33		23164CAK/W33		340	520	4	0.31	2.2	3.3	2.2	169
24164/W33		24164K30/W33	4003764Y	340	520	4	0.42	1.6	2.4	1.6	251
23264/W33		23264K/W33	3003264Y	340	560	4	0.37	1.8	2.7	1.8	259
24164/W33/YA				340	560	4	0.37	1.8	2.7	1.8	262
23968/W33		23968K/W33	3003968Y	353	447	2.5	0.18	3.8	5.6	3.7	50.5
23068/W33		23068K/W33	3003168Y	358	502	4	0.25	2.7	4	2.7	109
24068/W33		24068K30/W33	4003168Y	358	502	4	0.33	2	3	2	160
24068CA/W33		24068CAK30/W33		358	502	4	0.33	2	3	2	140
23168CA/W33		23168CAK/W33		360	560	4	0.31	2.2	3.3	2.2	209
24168CA/W33		24168CAK30/W33		360	560	4	0.39	1.7	2.6	1.7	280
23972/W33		23972K/W33	3003972Y	373	467	2.5	0.17	4	5.9	3.9	49.1
23072/W33		23072K/W33	3003172 Y	378	522	4	0.25	2.7	4	2.7	114

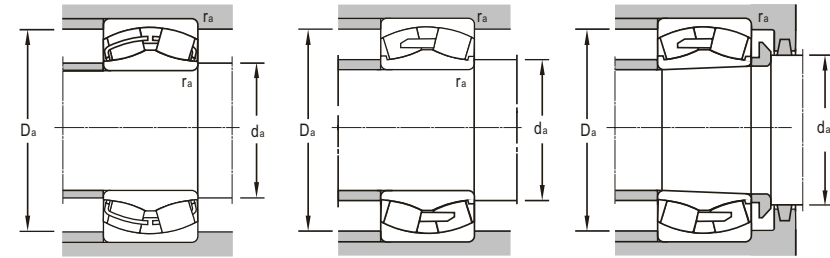
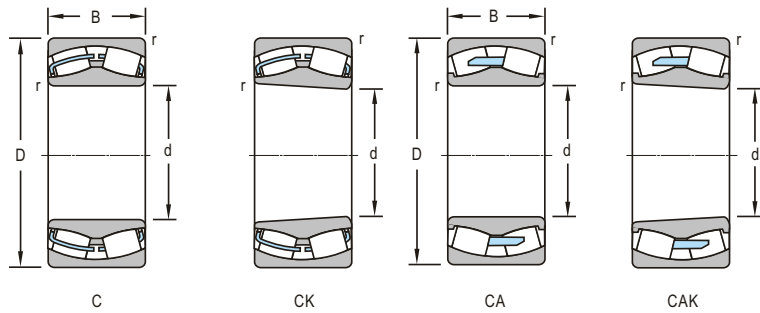

d 360~460mm

Boundary Dimensions				Basic Load Ratings		Limiting Speeds		
<i>d</i>	<i>D</i>	<i>B</i>	<i>r_{min}</i>	Dynamic <i>C</i>	Static <i>C₀</i>	Grease	Oil	
mm				kN		r/min		
360	540	134	5	2390	4700	600	760	
	540	180	5	3460	6350	500	630	
	540	180	5	3200	6160	480	620	
	600	192	5	3400	6700	560	700	
	600	243	5	4400	8370	430	530	
	600	243	5	4300	8210	430	530	
	600	243	5	4670	9040	430	530	
	650	232	6	4520	7930	420	510	
750	224	7.5	4900	7500	450	550		
380	520	106	4	1760	3420	800	1000	
	560	135	5	2280	4550	630	800	
	560	135	5	2480	5050	630	800	
	560	135	5	2610	4850	630	800	
	560	180	5	3240	6460	480	600	
	620	194	5	3450	6800	400	500	
	620	194	5	3700	7000	400	500	
	780	230	7.5	5340	8390	340	430	
400	590	142	5	2300	5000	700	900	
	600	148	5	2520	5450	540	670	
	600	148	5	2850	5610	540	670	
	650	200	6	3850	7540	380	480	
	720	256	6	5300	10100	340	430	
	720	315	6	6620	10400	310	390	
	820	243	7.5	5900	9360	360	450	
	401	720	256	6	5300	10100	340	430
420		620	150	5	2690	5750	450	560
		700	224	6	4850	9300	360	450
		700	280	6	5700	11300	300	380
	760	272	7.5	6450	11700	320	400	
440	600	118	4	2120	4570	550	700	
	650	157	6	2900	6050	430	530	
	720	226	6	4910	9600	340	430	
	720	280	6	5900	11900	280	360	
	720	280	6	6150	12300	300	380	
460	680	163	6	3150	6860	400	500	
	760	240	7.5	5450	10800	320	400	
	760	300	7.5	6660	13100	260	340	

Bearing Designations				Mounting Dimensions			Calculation Factors				Mass
Cylindrical Bore	Present		Original Cylindrical Bore	<i>d_{amin}</i>	<i>D_{amax}</i>	<i>r_{amax}</i>	<i>e</i>	<i>Y₁</i>	<i>Y₂</i>	<i>Y₀</i>	kg
	Tapered Bore	Tapered Bore									
23072CA/W33	23072CAK/W33	3053172HY	3153172HY	378	522	4	0.25	2.7	4	2.7	113
24072C/W33	24072CAK/W33	4053172Y	4453172Y	378	522	4	0.31	2.2	3.3	2.2	148
24072CA/W33	24072CAK/W33			378	522	4	0.31	2.2	3.3	2.2	148
23172W33	23172K/W33	3003772Y	3113772Y	380	580	4	0.32	2.1	3.1	2	221
24172W33	24172K30/W33	4003772Y	4113772Y	380	580	4	0.42	1.6	2.4	1.6	273
24172 CAK30/W33				380	580	4	0.42	1.6	2.4	1.6	271
24172C				380	580	4	0.4	1.7	2.5	1.6	269
23272 CAK30/W33				386	624	5	0.35	1.9	2.9	1.8	332
22372W33	22372K/W33			390	724	5	0.31	2.2	3.3	2.2	489
23976W33	23976K/W33	3003976Y	3113976Y	395	505	3	0.19	3.6	5.3	3.5	73.5
23076W33	23076 K/W33	3003176Y	3113176 Y	398	542	4	0.24	2.8	4.2	2.8	122
23076C				398	542	4	0.22	3	4.6	2.8	116
23076CA/W33	23076CAK/W33			398	542	4	0.22	3	4.5	2.9	114
24076W33	24076K30/W33			398	542	4	0.3	2.3	3.4	2.2	152
23176W33	23176 K/W33	3003776 Y	3113776 Y	400	600	4	0.34	2	2.9	1.9	243
23176CAQ1/W33	23176CAKQ1/W33			400	600	4	0.3	2.3	3.4	2.2	230
22376W33	22376K/W33			400	760	6	0.31	2.2	3.3	2.2	538
2680W33	2680K/W33			418	572	4	0.23	2.9	4.4	2.8	145
23080W33	23080K/W33	3003180 Y	3113180Y	420	582	4	0.25	2.7	4	2.7	165
23080CA/C3W33				418	582	4	0.23	4.4	2.8	150	
23180W33	23180K/W33	3003780 Y	3113780Y	426	624	5	0.31	2.2	3.3	2.2	238
23280W33	23280 K/W33	3003280Y	3113280 Y	426	694	5	0.37	1.8	2.7	1.8	530
24280W33	24280K30/W33			426	694	5	0.44	1.5	2.3	1.5	549
22380W33	22380K/W33	3680Y		432	788	6	0.37	1.8	2.7	1.8	650
		3G3-316		426	694	5	0.37	1.8	2.7	1.8	515
23084W33	24084K30/W33	3003184Y	3113184Y	438	602	4	0.24	2.8	4.2	2.8	158
23184W33	23184K/W33	3003784Y	3113784Y	446	674	5	0.32	2.1	3.1	2	402
24184CA/W33	24184CAK30/W33			446	674	5	0.38	1.7	2.6	1.7	434
23284CA/W33	23284CAK/W33	3053284HY	3153284HY	452	728	6	0.35	1.9	2.9	1.8	535
2388CA/W33				455	585	3	0.16	4.2	6.3	4	99
23088W33	23088K/W33	3003188Y	3113188Y	463	627	5	0.24	2.8	4.2	2.8	192
23188W33	23188K/W33	3003788Y	3113788Y	466	694	5	0.31	2.2	3.3	2.2	419
24188W33	24188K30/W33			466	694	5	0.38	1.7	2.6	1.7	443
24188 CAK30/C3W33				466	694	5	0.37	1.8	2.7	1.8	446
23092W33	23092K/W33	3003192Y	3113192Y	483	657	5	0.23	2.9	4.4	2.8	220
23192W33	23192K/W33			492	728	6	0.31	2.2	3.3	2.2	468
24192W33	24192K30/W33			492	728	6	0.37	1.8	2.7	1.8	539

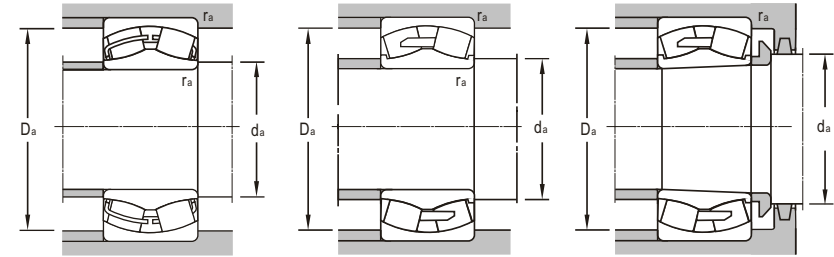
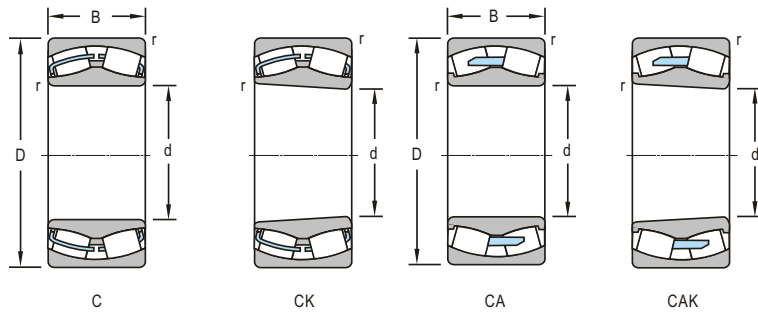

d 480~710mm

Boundary Dimensions				Basic Load Ratings		Limiting Speeds	
d	D	B	r _{min}	Dynamic C	Static C ₀	Grease	Oil
mm				kN		r/min	
480	650	128	5	2280	5480	400	500
	650	128	5	2900	5700	400	500
	700	165	6	3280	6910	380	480
	700	165	6	3540	7390	380	480
	790	248	7.5	5800	11400	300	380
	870	310	7.5	7350	13800	250	320
	870	310	7.5	7580	13800	260	340
	870	310	7.5	7580	13800	260	340
494	670	128	5	2440	6060	400	500
500	670	128	5	2440	6060	400	500
	720	167	6	3500	7600	380	480
530	780	185	6	3930	8550	340	430
	780	185	6	3560	8260	340	430
	780	185	6	4440	9320	340	430
	980	355	9.5	9960	18500	240	320
560	750	140	5	3150	7220	420	580
	820	195	6	4460	10020	300	380
	820	195	6	4700	10300	320	400
	820	258	6	6160	14000	340	420
	920	280	7.5	7990	16000	240	320
	920	280	7.5	7750	15300	240	320
	920	355	7.5	9450	19500	190	260
	920	355	7.5	9450	19500	190	260
600	870	200	6	4810	11000	300	380
	980	375	7.5	10400	21300	180	240
630	920	212	7.5	5360	12200	260	340
670	900	170	6	4130	9840	260	340
	900	170	6	4260	10000	260	340
	980	230	7.5	6240	13700	240	320
	980	308	7.5	8440	19700	220	300
	1090	412	7.5	12500	26900	210	280
	1220	438	12	15500	30200	190	250
710	950	180	6	4290	10900	240	320

Bearing Designations				Mounting Dimensions			Calculation Factors				Mass
Cylindrical Bore	Present Tapered Bore	Original Cylindrical Bore	Original Tapered Bore	d _{amin}	D _{amax}	r _{amax}	e	Y ₁	Y ₂	Y ₀	kg
23996/W33	23996K/W33	3003996Y	3113996Y	498	632	4	0.18	3.8	5.6	3.7	161
23996 CAF1/W33				498	632	4	0.18	3.8	5.6	3.6	125
23096/W33	23096K/W33	3003196Y	3113196Y	503	677	5	0.24	2.8	4.2	2.8	231
23096CAK/P53/W33				503	677	5	0.21	2.3	4.8	3.2	210
23196CA/W33	23196CAK/W33			512	758	6	0.3	2.3	3.4	2.2	492
23296/W33	23296K/W33	3003296Y	3113296Y	512	838	6	0.39	1.7	2.6	1.7	837
23296CA/W33	23296CAK/W33			512	838	6	0.36	1.9	2.8	1.8	857
23296CA/W33				512	838	6	0.35	1.9	2.9	1.8	881
239494/W33	239494K/W33			512	652	4	0.18	3.8	5.6	3.7	135
239500/W33	239500K/W33	30039500Y	31139500Y	518	652	4	0.18	3.8	5.6	3.7	130
230500/W33	230500K/W33	30031500Y	31131500Y	523	697	5	0.23	2.9	4.4	2.8	238
230530/W33	230530K/W33	30031530Y	31131530Y	553	757	5	0.23	2.9	4.4	2.8	313
230530 D-1				553	757	5	0.23	2.9	4.4	2.8	317
230530CAK/W33 YB				553	757	5	0.22	2.9	4.6	2.8	300
232530CA/W33	232530CAK30/W33			622	888	6	0.36	1.9	2.8	1.8	1210
239560CA/W33				578	732	4	0.16		6.3	4	168
230560/W33	230560K/W33	30031560Y	31131560T	583	797	5	0.23	2.9	4.4	2.8	365
230560CA/W33	230560CAK/W33			583	797	5	0.22	3	4.5	2.9	354
240560 CA/W33				583	797	5	0.28	2.4	3.6	2.5	472
231560/W33	231560K/W33	30037560Y	31137560Y	592	888	6	0.3	2.3	3.4	2.2	757
231560CA/W33S2				592	888	6	0.3	2.3	3.4	2.2	762
241560CA/W33	241560CAK30/W33			592	888	6	0.37	1.8	2.7	1.8	985
241560 CA-1/W33				592	888	6	0.37	1.8	2.7	1.8	947
230600/W33	230600K/W33	30031600Y	31131600Y	623	847	5	0.22	3	4.5	2.9	393
241600/W33	241600K30/W33	40037600Y	41137600Y	632	948	6	0.37	1.8	2.7	1.8	1079
230630/W33	230630K/W33	30031630Y	31131630Y	658	892	6	0.23	2.9	4.4	2.8	509
239670/W33	239670K/W33	30039670Y	31139670Y	693	877	5	0.18	3.8	5.6	3.7	317
239670 CAF1/W33				693	877	6	0.17	4	5.9	4	308
230670/W33	230670K/W33	30031670Y	31131670Y	698	952	6	0.23	2.9	4.4	2.8	655
240670CA/W33S2				698	952	6	0.28	2.4	3.6	2.5	806
241670CAK30C3/W33				702	1058	6	0.37	2.7	2.7	1.8	1507
232670CAK30C3/W33				718	1172	10	0.35	1.9	2.9	1.8	2275
239710/W33	239710K/W33	30039710Y	31139710Y	732	927	5	0.18	3.8	5.6	3.7	387

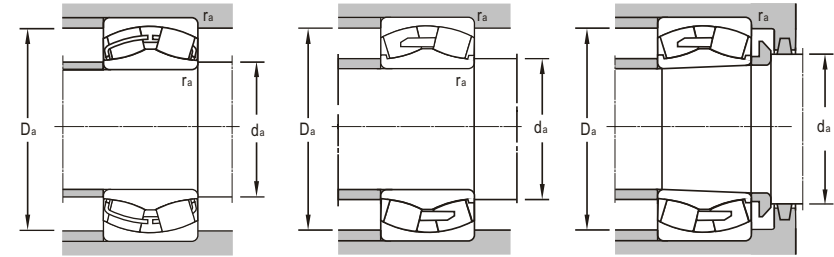
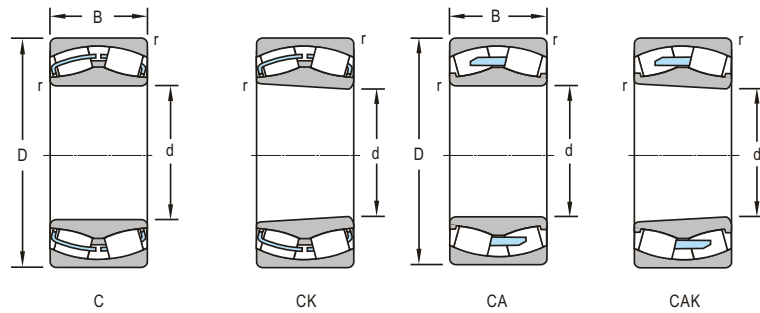

d 710~1440mm

Boundary Dimensions				Basic Load Ratings		Limiting Speeds	
<i>d</i>	<i>D</i>	<i>B</i>	<i>r_{min}</i>	Dynamic <i>C</i>	Static <i>C₀</i>	Grease	Oil
mm				kN		r/min	
710	1030	236	7.5	6530	15130	220	300
	1030	315	7.5	8890	20700	210	290
	1150	438	9.5	13700	29940	150	190
750	1090	250	7.5	7890	17600	200	280
	1090	335	7.5	9340	22300	190	240
	1090	335	7.5	9340	22300	180	260
	1360	475	15	18500	35700	150	210
800	1060	258	6	7170	19030	200	280
	1150	258	7.5	8630	20000	190	260
	1150	345	7.5	10000	25700	170	220
850	1030	136	5	3640	10300	170	210
	1120	200	6	6010	15300	190	260
	1120	200	6	6100	15800	190	260
	1220	272	7.5	9050	21100	180	240
	1220	365	7.5	10000	26000	160	200
	1220	365	7.5	10000	26000	160	200
	1220	365	7.5	11700	28900	160	200
900	1270	365	7.5	12200	31100	160	200
	1280	375	7.5	12200	31100	150	190
1000	1420	308	7.5	12000	29000	190	250
	1420	412	7.5	15000	40000	120	160
	1580	580	12	24500	56700	110	150
1120	1580	345	12	14400	34800	90	120
	1580	462	9.5	18500	48000	100	140
1180	1540	272	7.5	10400	27700	100	140
	1660	355	9.5	15500	38400	90	120
1200	1500	280	7.5	10000	29700	80	120
1250	1750	500	9.5	20000	52600	80	105
1320	1850	530	7.5	23900	64400	70	90
1440	1760	315	7.5	12000	39200	75	95

Bearing Designations				Mounting Dimensions			Calculation Factors				Mass
Cylindrical Bore	Present	Tapered Bore	Original	<i>d_{amin}</i>	<i>D_{amax}</i>	<i>r_{amax}</i>	<i>e</i>	<i>Y₁</i>	<i>Y₂</i>	<i>Y₀</i>	kg
	Cylindrical Bore		Tapered Bore								
230/710W33	230/710K/W33	30031/710Y	31131/710Y	738	1002	6	0.23	2.9	4.4	2.8	742
240/710CA				738	1002	6	0.27	3.7	2.5		890
241/710W33	241/710K30W33	40037/710Y	41137/710Y	750	1110	8	0.38	1.7	2.6	1.7	1802
230/750W33	230/750K/W33			778	1062	6	0.22	3	4.5	2.9	855
240/750W33				782	1058	6	0.28	2.4	3.6	2.5	1060
FD-240/750W33				778	1062	6	0.28	2.4	3.6	2.5	1060
232/750CAK30F1/C3W33				808	1302	12	0.35	1.9	2.9	1.8	3043
249/800W33	249/800K30W33	40039/800Y	41139/800Y	823	1037	5	0.22	3	4.5	2.9	638
230/800W33	230/800K/W33	30031/800Y	31131/800Y	828	1122	6	0.21	3.2	4.8	3.1	986
240/800W33	240/800K30W33	40031/800Y	41131/800Y	828	1122	6	0.29	2.4	3.5	3.3	1246
238/850CA/C4W33S2				868	1012	4	0.11	6.1	9.1	6.3	232
FD-239/850CAW33				876	1097	5	0.16	6.2	4.1		549
239/850W33	239/850K/W33	30039/850Y	31139/850Y	873	1097	5	0.16	4.2	6.2	4.1	531
230/850W33	230/850K/W33			878	1192	6	0.21	3.2	4.8	3.1	1069
240/850W33	240/850K30W33	40031/850Y	41131/850Y	878	1192	6	0.28	2.4	3.6	2.5	1398
240/850YA		40031/850Y1		878	1192	6	0.28	2.4	3.6	2.5	1396
240/850CA/C4W33S2				878	1192	6	0.27	2.5	3.7	2.5	1430
26/900/C3W33XVA3				928	1242	6	0.27	2.5	3.7	2.5	1703
240/900W33	240/900K30W33	40031/900Y	41131/900Y	928	1252	6	0.27	2.5	3.7	2.5	1783
230/1000CAW33C4				1028	1392	6	0.19		5.3	3.6	1609
240/1000W33	240/1000K30W33	40031/1000Y	41131/1000Y	1028	1392	6	0.27	2.5	3.7	2.5	2117
241/1000CAK30W33				1048	1532	10	0.35	2.9	1.8		4290
230/1120CA/C4 YB				1160	1540	10	0.19		3.5	2.3	2155
240/1120 CA/W33				1159	1541	8	0.26	2.6	3.9	2.5	2908
239/1180 CA/W33				1214	1506	6	0.16	4.2	6.3	4	1360
230/1180W33	230/1180K/W33			1210	1630	8	0.2	3.4	5.1	3.3	2480
539/1200CAW33C3				1236	1464	6	0.162		6.2	4.1	1150
240/1250CA/C4 YB				1290	1710	8	0.26		3.8	2.5	3854
240/1320CAF/C3W33				1360	1810	6	0.26		3.8	2.5	4504
239/1440F3/C3W33				1480	1720	6	0.15		6.6	4.3	1597

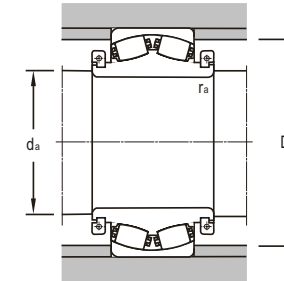
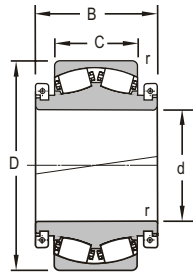



d 300~1320mm

Boundary Dimensions					Basic Load Ratings	
<i>d</i>	<i>D</i>	<i>C</i>	<i>B</i>	<i>r_{min}</i>	Dynamic <i>C</i>	Static <i>C₀</i>
mm					kN	
300	500	160	240	5	2710	4940
480	870		310	7.5	7090	13300
530	780	185	288	6	3580	9110
560	820	195	300	6	4060	10600
630	920	212	330	7.5	5650	13100
710	1030	180	370	6	5070	12300
750	1090	310	310	7.5	7670	17000
	1090	250	310	7.5	7670	17000
800	1200	295	450	7.5	10100	22100
850	1220	365	660	7.5	10700	27800
	1220	365	540	7.5	9320	27800
	1220		365	7.5	10700	26000
900	1270	365	470	7.5	11100	33400
950	1360	300	420	7.5	10900	25500
1180	1540		500	9.5	12900	36000
1320	1850	666	10X45°		21900	57200
	1850	815	12		21900	57200

Bearing Designations		Calculation Factors				Mass
Present	Original	<i>e</i>	<i>Y₁</i>	<i>Y₂</i>	<i>Y₀</i>	
		mm				kg
23160D/W33X		0.32	2.1	3.1	2	150
23296D/W33		0.35		2.9	1.8	821
230/530D		0.23	2.9	4.4	2.8	415
230/560D/W33		0.23	2.9	4.4	2.8	478
230/630D/W33X		0.23	2.9	4.4	2.8	679
239/710X1D/C4W33X		0.17	4	5.9	3.9	718
26/750D/C4		0.22	3	4.5	2.9	920
230/750D/W33X		0.22	3	4.5	2.9	847
26/800D/W33X		0.23	2.9	4.4	2.8	1676
240/850D/W33		0.28	2.4	3.6	2.5	1944
240/850D-1/W33		0.28	2.4	3.6	2.5	1790
240/850D-5/W333X		0.28		3.6	2.5	1394
26/900D/C3W33X		0.27	2.5	3.7	2.5	1908
230/950D/W33X		0.2	3.4	5.1	3.3	1770
249/1180D/C3W33X		0.2		5	3.3	2246
240/1320D/C3W33X-1		0.26		3.8	2.5	5240
240/1320D/C3W33X		0.26	2.6	3.8	2.5	6021

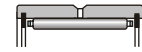

Needle Roller Bearings and Universal Joint Bearings

	 241
---	---	-----------

Single Row Needle Roller Bearings

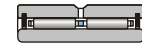
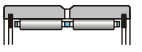
	 247
---	---	-----------

Double-Row Needle Roller Bearings

 253
---	-----------

Long Cylindrical Roller Bearing



**Needle Roller Bearings and Universal Joint Bearings**

LYC's needle roller bearings have small axial section dimension, good rigidity and capacity to carry high radial loads, which are suitable for limited radial installing when positions. These are widely applied under working situation with swiveling shaft and bearing housing. However, needle roller bearing can only carry pure radial load, but, can't prevent the axial displacement between shaft and bearing housing. In addition, the angle error for inner axle and outer axle is not allowed.

Type NA, RNA

LYC's standard needle roller bearings are NA type, which has flange or spring lock ring at the two sides of outer ring, and a flangeless inner ring. There are two structures including single row and double rows. Either the single or double-row bearings can be produced into type NA with inner ring, or type RNA without inner ring.

For larger sizes, there are circularity lubrication grooves and holes on outer ring. Outer assembly of type NA's (outer ring, needle rollers and cage) are non-separated, but inner ring can be parted from outer assembly.

When needle rollers bearings are without an inner ring, its rollers would have direct contact with shaft surface. In this way, the hardness and dimension of journal must reach the requirements of bearing raceway.

Type NAV, RNAV

Bearings of type NAV and RNAV are filled with rollers without a cage. These are another type derived from type NA and RNA. Their carrying capacity is larger than type NA and RNA. However the rotating speeds are lower.

Type NAO

Type NAO have a flangeless inner ring and outer ring, with two structures as single row and double rows. For double-row needle roller bearing, it has a lubrication groove and hole on the outer ring.

Type K

Type K is also called "needle and cage assembly" without an inner and outer ring, it has the smallest radial dimension of bearing. It works directly on shaft surface and bearing housing, so the matching shaft and bearing houses must ensure hardness and dimensional accuracy.

Long Cylindrical Roller Bearings

The characteristics of long cylindrical roller bearings are similar to needle roller bearing, however, their radial section dimensions are larger than needle roller bearings. Therefore, they can carry a larger radial load.

For the long cylindrical roller and needle roller, the length-diameter ratios are both greater than 3. The major difference is that the former's roller length is over 5mm, the later is smaller than 5mm. So they are mostly similar on their structures.

Similar to the needle roller bearing, long cylindrical roller bearings can also only take pure radial load, but, do not prevent the axial displacement between the shaft and bearing housing, additionally, the angle error for inner axial and outer axial is not allowed.

Type NAOL

Similar to the type NAO, bearings of type NAOL have flangeless inner ring and outer ring.

Type NAL

Similar to type NA, these bearings have flanges or spring lock rings at the two sides of outer ring, but, are without a flange on inner ring.

Universal Joint Bearings

LYC's universal joint bearing has a outer ring with a particular figured structure and an assembly side and full set of rollers or needle rollers, but, is without a inner ring. Universal joint bearings usually have a shield or sealed cup to prevent contaminants entering into bearing.

The universal joint bearing is widely used in universal joint applications such as motor, steel mills, crane, and transport machinery. The rings of this type of bearing are required to be specially heat treated, so that it can endure heavy impact loads. The design of this smaller section dimension allows space saving in the structure of universal joint cross axis.

The universal joint bearing works directly on the shaft surface and bearing housing. Therefore, the matching shaft and bearing housing must maintain enough hardness and dimensional precision.

LYC can provide other structures of needle roller bearings or long cylindrical roller bearing to meet customers requirements, such as needle roller bearing (or long cylindrical roller bearing) with a pressed outer ring etc. All these configurations can not be listed here. If customers require these

applications, please consult the LYC technical department.

Cage

LYC's needle roller bearings are supplied with a pressed steel cage, a machined solid cage or glass fiber reinforced polyamide 66 on other engineering plastics. The cages of materials are identified by a suffix, these suffix are explained in the chapter "LYC Bearing Designation".

Minimum load

In order to maintain bearings working in a good condition, a minimum load must be imposed on bearings, particularly on bearings working at high speeds, with high accelerations, or with the load direction changing frequently, because under these working conditions, inertial force of balls and cage and lubricant friction will have bad influence on the rotation of bearings, and detrimental sliding movement may be caused.

The minimum load of a needle roller bearing can be obtained from.

$$F_{\min}=0.02C$$

where

C-Basic dynamic loading rating, N

Dimension, Tolerance, Clearance

LYC's standard needle roller bearing boundary dimensions are according to GB/T273.3 <Rolling Bearing, Radial Bearing, and Boundary Dimension General Specification>, GB/T290 <Rolling Bearing, Needle Roller Bearing with Pressed Outer Ring, and Boundary Dimension>, JB/T7918 <Rolling Bearing, Radial Needle and Cage Assembly>.

JB/T 3588 <Rolling Bearing, Needle Roller Bearing Full of Rollers, Boundary Dimension and Tolerance>, G/T3370 <Rolling Bearing, and Cylindrical Roller Bearing for Universal Joints >. LYC's standard needle roller bearing tolerance is according to GB/T307.1 <Rolling Bearing, Radial Bearing, and Tolerance>

The clearance of LYC's needle rolling bearing with inner and outer ring is according to GB/T4604 <Rolling Bearing, and Radial Clearance>. Clearance for the bearings without inner and outer ring or only with one ring is dependant on the diameter of axle or diameter tolerance of bearing housing's inner hole.

The dimensional tolerance of LYC's standard needle roller bearing is the normal grade P0, the

clearance is group 0. If customers have additional special requirements on dimension, tolerance, and clearance, then LYC have the ability to supply the corresponding products, including non-standard type.

Equivalent Dynamic (Static) Load

This type of bearing can only carry pure radial load, so the equivalent dynamic load is the same as its equivalent static load. The equivalent dynamic (static) load is calculated from

$$P=P_0=Fr$$

Where

P – Equivalent dynamic load, N

P₀ – Equivalent static load, N

Fr – Radial load, N



Needle Roller Bearings

single row
with spring lock ring on outer ring

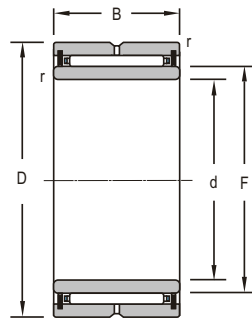

d 12~220mm

Boundary Dimensions					Basic Load Ratings		Limiting Speeds	
<i>d</i>	<i>D</i>	<i>B</i>	<i>F</i>	<i>r</i>	Dynamic <i>C</i>	Static <i>C₀</i>	Grease	Oil
mm					kN		r/min	
12	24	13	16	0.3	10.1	11.7	15000	23000
20	37	17	25	0.3	21.3	25.5	11000	16000
25	42	17	30	0.3	24	31.5	8500	13000
30	47	17	35	0.3	25.5	35.5	7500	11000
35	55	20	42	0.6	32	50	6600	9500
40	65	22	48	0.6	43.5	66.5	5500	8500
	62	22	48	0.6	43.5	66.5	5500	8500
45	68	22	52	0.6	45	72	5500	8000
50	72	22	58	0.6	48	80	5000	7000
55	85	25	63	1	58.5	99.5	4300	6000
	80	25	63	1	58.5	99.5	4500	6300
65	90	25	72	1	62.5	112	3700	5500
70	100	30	80	1	85.5	156	3300	5500
80	110	30	90	1	90.5	174	2900	4400
85	120	35	100	1.1	112	237	2500	3800
90	125	35	105	1.1	116	252	2500	3800
110	150	40	125	1.1	149	315	2100	3200
120	165	45	135	1.1	192	395	2000	3000
140	175	35	155	1.1	133	340	1700	2600
170	215	45	185	1.1	185	495	1500	2200
180	225	45	195	1.1	195	540	1400	2100
220	270	50	240	1.5	242	770	1100	1700

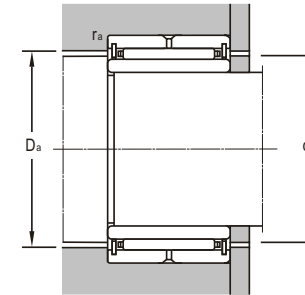

Bearing Designations		Mounting Dimensions			Mass
Present	Original	<i>d_{amin}</i>	<i>D_{amax}</i>	<i>r_{amax}</i>	
		mm			kg
NA4901	4524901	14	22	0.3	0.0303
NA4904	4524904K	22	35	0.3	0.0851
NA4905	4524905	27	40	0.3	0.0963
NA4906	4524906	32	45	0.3	0.109
NA4907	4524907	39	51	0.6	0.179
NA608	524708	44	58	0.6	0.315
NA4908	4524908	45	60	0.6	0.266
NA4909	4524909	49	64	0.6	0.298
NA4910	4524910	54	68	0.6	0.319
NA611	524711	61.5	78.5	1	0.562
NA4911	4524911	60	75	1	0.448
NA4913	4524913	70	85	1	0.521
NA4914	4524914	75	95	1	0.825
NA4916	4524916	85	105	1	0.91
NA4917	4524917	91.5	113.5	1	1.39
NA4918	4524918	96.5	118.5	1	1.43
NA4922	4524922	116.5	143.5	1	2.28
NA4924	4524924	126.5	158.5	1	2.96
NA4828	4524828	146.5	168.5	1	2.17
NA4834	4524834	176.5	208.5	1	4.31
NA4836	4524836	186.5	218.5	1	4.6
NA4844	4524844	228	262	1.5	7.12



Needle Roller Bearings

double-row
with spring lock ring on outer ring

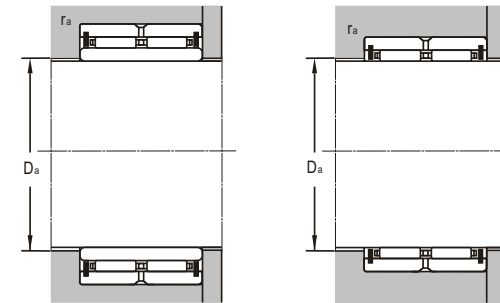
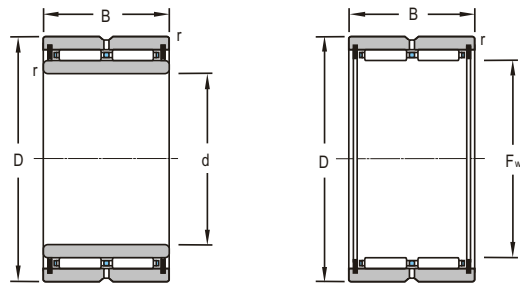

d 25~80mm

Boundary Dimensions					Basic Load Ratings		Limiting Speeds	
d	F _w	D	B	r	Dynamic C	Static C ₀	Grease	Oil
mm					kN		r/min	
25		42	30	0.3	41.5	63	8500	13000
30		47	30	0.3	44	71.5	7500	11000
35		55	36	0.6	57.5	106	6100	9500
40		62	40	0.6	72	137	5600	8000
45		68	40	0.6	76	149	5300	7500
80		110	54	1	149	325	3200	4500
	20	32	30	0.3	17.6	12.8	13000	20000
	22	30	30	0.3	18.6	28.8	12000	18000
	25	37	30	0.3	36.5	50.5	11000	16000
	32	45	30	0.5	43	67	8500	13000
	35	47	30	0.3	44	71.5	7500	11000
	42	55	36	0.6	57.5	106	6500	9500
	52	68	40	0.6	76	149	5000	7500

Bearing Designations		Mass
Present	Original	
		kg
NA6905A	6534905	0.167
NA6906A	6534906	0.202
NA6907A	6534907	0.329
NA6908A	6534908	0.488
NA6909A	6534909	0.544
NA6916A	6534916	1.67
RNA602A	6634102	0.0938
RNA6903X2A	634704	0.059
RNA6904A	6634904	0.108
RNA69/28A	634906	0.138
RAN6906A	6634906	0.143
RNA6907A	6634907	0.211
RNA6909A	6634909	0.38



Needle Roller Bearings

universal joint with inner ring

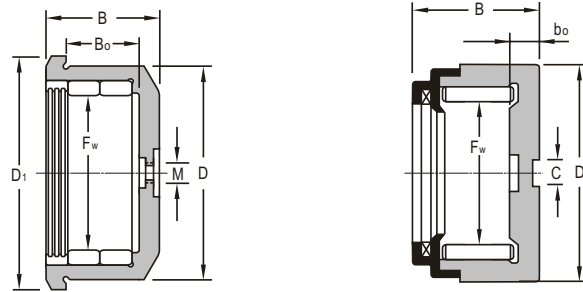

Boundary Dimensions							
F_w	D	D_1	B	b	b_0	H	C
mm							
14	24		16.6		3		
	24		16.6		3		
15.2	28	25.7	19	11	4.25	2.5	
16.3	30	27.5	21	12.5	3.95	3	
22	35		3		4		10
25	39		28		5		9.9
	39		32.6		5		9.9
	39		32.6		5		9.9
	39		32.6		5		
33.65	50		34.4		4		9
	50		28.4		4		9
45	62		34.4		4		9
	62		36.5		4		9

Bearing Designations		Mass
Present	Original	
		kg
58049/14	804902	0.0301
58049/14/YA	804902K	0.035
57049/15	704902	0.06
57049/16	704702	0.0701
58049/22	804704	0.0949
58049/25-FS	804705	0.127
58049/25-RSFS	804705K	0.137
58049/25-RS	804705K1	0.14
58049/25-RS/YA	804705K2	0.145
58049/34	804906	0.306
58049/34 X2	804907	0.203
58049/45	804709	0.435
58049/45-RS	804709K	0.45



Needle Roller Bearings

Cylindrical roller bearing for universal joint without inner ring

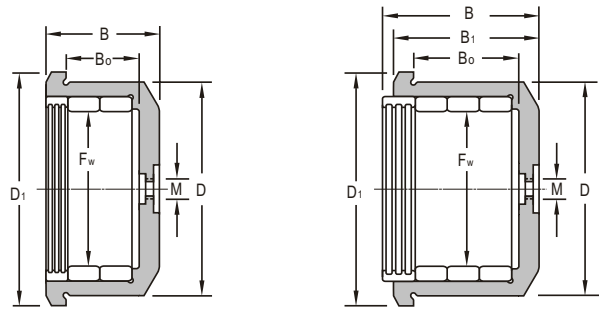

Boundary Dimensions						
F_w	D	D_1	B	B_0	B_1	M
mm						
32.44	52	60	47	26		6
36.3	60	68	53	31		6
40.1	66	74	59	34		6
45.8	74	82	65	36		6
	74	82	65	36		
51.5	83	91	73.5	44.5		
	83	91	73.5	44.5		10x1
60.5	95	105	81	49.5		
	95	105	81	49.5		10x1
70	110	122	89	56		
	110	122	89	56		10x1
76.25	120	134	88	64		
	120	134	95	64	88	
80.2	124	135	96	60		10x1
86.8	130	142	103	69		10x1
100	154	166	111	76		10x1
109.7	164	175	105	85		10x1
109.7	164	175	113	78		10x1
158	230	250	160	110	170	10x1
188.8	260	280	195	134	185	10x1

Bearing Designations		Mass
Present	Original	
		kg
604906	604906	0.673
604907	604907	0.799
604908	604908	1.06
604909	604909	1.42
604909/YA3	604909K	1.43
604910/YA3	604909K	1.9
604910	604710Y	1.9
604912/YA3	604712	2.67
604912	604712Y	2.66
604914/YA3	604714	3.75
604914	604714Y	3.74
604915/YA3	604715	4.42
604915	607415K	4.69
604916	604716	5.18
604917	604717	5.48
604920	604920	9.17
604922/YB2	604722	9.2
604922	604922	9.77
604932	3-476	27.2
604938	3-475	37.1



Needle Roller Bearings

long cylindrical roller

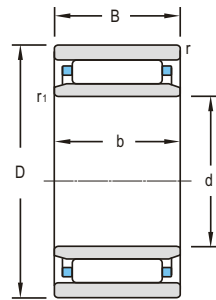

d 60~850mm

Boundary Dimensions						Basic Load Ratings		Limiting Speeds	
d	D	B	b	r ₁	r	Dynamic C	Static C ₀	Grease	Oil
mm						kN		r/min	
60	120	58	60	3.5	0.8	161.4	201.7	5556	7000
	120	58	60	3.5	0.8	148.9	186.2	5556	7000
	120	58	60	3.5	0.8	161.4	201.7	5556	7000
100	165	65		2	2	326	524	2000	3000
180	280	219		2.1	2.1	1490	3240	1600	2500
206.375	285.75	222.225		4	4	1330	3960	1500	2200
209.55	282.575	236.525		2.1	2.1	1330	3960	1500	2200
220	380	175		2	2	1814.4	2268	1333	1680
240	380	100		5	5	1054	1317.5	1290	1626
	400	160		4	4	1736	2170	1234	1555
282	334	87	118		1	829.6	1073	1299	1636
355	470	110		3.5	3.5	1418.1	1772.6	874	1101
380	485	75		3.5	3.5	846	1057.5	797	1004
450	590	100		5	5	1434.4	1793	615	763
850	1030	136		6	6	4121	5151.6	234	295

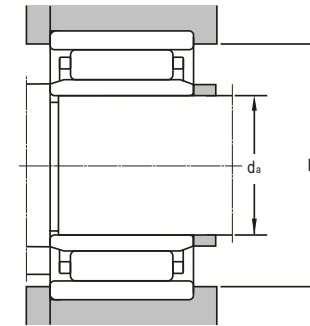

Bearing Designations		Mass
Present	Original	
		kg
NAOL612WB	404712	3.29
NAOL612WBJ	404712K	3.17
NAOL612WB JW	404712F	3.32
NAL4120M/YA		5.51
NNAL6036X2M		50
	254941HKU	46.5
NNAL6209.55Q1/C9W33XYB2		44.8
NAOL644	4744	87.1
NAOL648	4748	46.6
NAOL4148	4004748	83.8
NAOL6/282WBJR	414956	16.48
NAOL671	4771	53
NAOL3876X1	4776	38.5
NAOL690	4990	70.5
NAOL38/850	32048/850	263



Needle Roller Bearings

long cylindrical roller and cage assembly

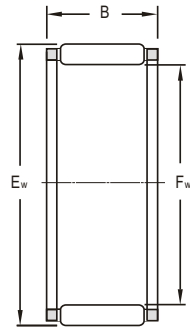

Boundary Dimensions		
F_w	E_w	B
mm		
19.05	31.775	34
19.051	28.588	36.75
19.051	28.588	43.25
20	30.02	18
20.612	33.325	35
25	38	24.7
25.4	41.288	60.4
27.71	42.825	44.1
29.975	42	44.1
31.675	46.81	44.1
32	52.012	49
32	37	35.8
37	42	29.79
38	43	35.7
52.412	71.425	43.3
82.5	92	38
88.8	101.5	38
130	138	25

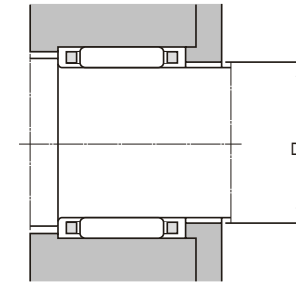

Bearing Designations		Mass
Present	Original	
		kg
K19.05X31.775X34JR	64804	0.0903
K19.051X28.588X36.75JR	64903	0.068
K19.051X28.588X43.25JR	64904	0.08
K20X30.02X18JR	64704	0.0386
K20.612X33.325X35JR	64904K	0.1
K25X38X24.7JR	64805	0.0783
K25.4X41.288X60.4JR	64905	0.265
K27.71X42.825X44.1JR	64906	0.183
K29.975X42X44.1JR	64706	0.147
K31.675X46.81X44.1JR	64906K	0.217
K32X52.012X49JR	64907	0.329
K32X37X35.8ZWDTN1		0.028
K37X42X29.79ZWDTN1		0.0277
K38X43X35.7ZWDTN1		0.0333
K52.412X71.425X43.3JR	64911	0.441
K82.5X92X38		0.224
K88.8X101.5X38		0.348
K130X138X25JR	9247/130	0.212

Angular Contact Ball Bearings

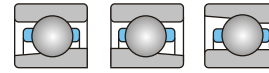

Angular Contact Ball Bearings

263

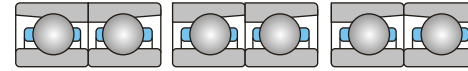

Paired Mounting Angular Contact Ball Bearings

279

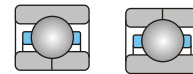

Four-Point Contact Ball Bearings

293



Angular Contact Ball Bearing

LYC's angular ball bearings are also called angular contact radial thrust ball bearings. This type of bearing is particularly suitable for carrying combined loads (radial and axial load) as well as pure axial loads and can be operated at relatively high speeds.

The axial load carrying capacity of angular contact ball bearings changes along with dimensions of contact angle. The larger the contact angle, the better the axial load carrying capacity is.

The contact angle α is defined as the angle between the line joining the contact points of the ball and the raceways in the radial plane, along which the load is transmitted from one raceway to another, and a line perpendicular to the bearing axis.

The allowable angle error of a single row contact ball bearing is limited. The angle errors of inner ring and outer ring are dependent on radial clearance, bearing dimension, internal structure, and the force or moment acting on bearings. The relationship of those factors is so complicated that an accurate value can't be provided at present. When the clearance of paired mounting angular contact ball bearings (or double-row angular contact ball bearing), especially of those arranged back to back, is respectively small, once angular errors are made between the inner ring and outer ring, balls and cages would carry more additional load, and the bearing life would also be shortened. Any angular error would cause noise.

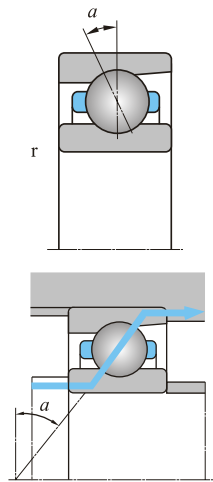

Fig. 1

Single Row Angular Contact Ball Bearings Single Mounting

When single row angular contact ball bearings can carry pure radial loads only, an axial thrust load caused by the radial load imposed on the bearing must be counteracted by an equal force. Two single row angular contact ball bearings are usually mounted face to face (See Fig.2). The single row angular contact ball can only carry axial load in single direction. They are mainly used in the arrangement where there is only one bearing in each support.

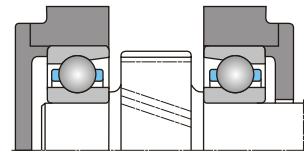

Fig. 2

LYC's standard single row angular contact ball bearings have separated and non-separated designs. Contact angles of separated bearings are 15° , contact angles of non-separated bearings are 15° , 25° or 40° respectively. Separated angular contact ball bearings can be divided into removable inner ring and removable outer ring according to the internal structures. Angular contact ball bearing with an angle 40° (see Fig.2) can bear comparably heavy axial loads. The structure of this kind of bearing is non-separated. In order to fill more balls and increase load carrying capacity, the shoulder height of each side of inner ring and outer ring is different.

Paired Mounting

In many situations, single row angular contact ball bearings are supplied to customers in pairs or multi-arrangement. LYC's paired mounting angular contact ball bearing arranged in pairs are specially processed. When bearings are installed abutting each other, any kind of arrangement can help to achieve predetermined inner clearance, preload and equally distributed load. No adjustment is need again. Angular contact ball bearings in pairs are used in these applications when single angular contact ball bearing load carrying capacity is not enough, when carrying axial (radial) combined load, and when carrying axial load in more than two directions. There are three ways to arrange angular contact ball bearings: in tandem, back to back and face to face.

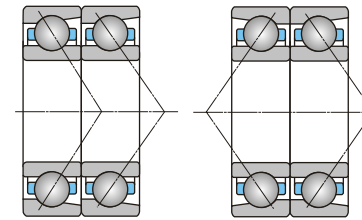

Fig. 3a)

Fig. 3b)

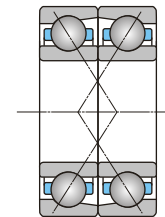

Fig. 3c)

When arranged in tandem, the load lines are in parallel. The radial and axial loads are evenly divided between the bearings. The bearing in tandem are only able to carry axial load in one direction (See Fig.3a).

The load lines of bearings mounted back-to-back diverge at both sides of bearings and intersect with the bearing axis. Axial loads acting in both directions can be carried, but only by one bearing in each direction. Bearings mounted back-to-back provide a relatively stiff arrangement which can also bearing tilting moments(See Fig.3b).

The loads lines of bearings mounted face to face are crossed, then they intersect with axis. Face to face arranged bearings could carry the axial load in both directions, but, only by one bearing in each direction. Their rigidity is lower than the bearings mounted back to back, which cannot bear tilting moments (See Fig.3c).

Three (Four) Points Contact Ball Bearings

Three (four) points contact ball bearing is a single row angular contact ball bearing with one split inner ring or one split outer ring. It can carry axial load and can limit the axial displacement in both directions. It takes up less axial space than a double-row bearing. The split inner ring permits the incorporation of a large number of balls and, as a consequence the load carrying capacity is high. The bearing is separable, so that the inner ring and the outer ring with ball and cage assembly can be mounted individually.

Double-Row Angular Contact Ball Bearings

The design of double-row angular contact ball bearings is almost the same with that of single row angular contact ball bearing, but, the axial dimension is comparably smaller. Double-ow angular contact ball bearings correspond in function to two single row bearings arranged back-to-back. The double-row bearings can also accommodate axial loads in both directions as well as tilting moments.

The double-row angular contact ball bearing has an outer ring and an inner ring (or two inner rings). Angular contact ball bearings with other structures can also be supplied by LYC, e.g. angular contact ball bearing with seals (shields) or snap groove on outer ring, etc. All types can't be listed in this catalogue. If customers need, please consult LYC technical department.

Cage

Cages of angular contact ball bearings supplied by LYC are pressed steel cages, machined solid cages, special glass fiber reinforced polyamide 66 cages, etc. Machined solid cages are mainly made of brass, bronze, various light alloys and phenolic resin. Angular contact ball bearings are used as high speed spindle bearings, cages are usually made of phenolic resin. Cages of different material are identified by suffix. Further details will be found in LYC catalogue "Bearing Material".

Load Carrying Capacity of Bearings Mounted in Pairs

Basic load ratings in the product table are only suitable for mounting single bearing. Basic load ratings for single bearings arranged in pairs can be obtained from

Basic dynamic load ratings:

In tandem: $C_1=2C_0$

Back to back or face to face or other arrangement:

$C_1=1.62C_0$

Basic static load rating: $C_{02}=2C_0$

- C – Basic dynamic load rating of a single angular contact ball bearing.
- C_1 – Basic dynamic load rating of angular contact ball bearings arranged in tandem, face to face or back to back.
- C_0 – Basic static load rating of a single angular contact ball bearing.
- C_{02} – Basic static load rating of angular contact ball bearings arranged in tandem, face to face or back to back.

The speed of two single bearings mounted in pairs:

The limiting speeds of bearings in product table are only suitable for single bearings. The limiting speed of two single bearings arranged in pairs is 0.8 times that of a single bearing.

Minimum Load

In order to keep bearings working in a good condition, a minimum load must be imposed on bearings, particularly on bearings working at high speeds, high accelerations, or with the load direction changing frequently, because under these working conditions, inertial force of balls and cage and lubricant friction will have bad influence on the rotation of bearings, and detrimental sliding movement may be caused.

The minimum load of a single angular contact ball bearing can be obtained from

$$F_{rmin} = ka \frac{C_o}{1000} \left(\frac{nd_m}{100000} \right)$$

For the bearings arranged face-to-face or back-to-back.

$$F_{amin} = kr \left(\frac{vn}{1000} \right)^{\frac{2}{3}} \left(\frac{d_m}{100} \right)^2$$

where

- F_{rmin} — Minimum radial load, N
- F_{amin} — Minimum radial load, N
- C_o — Static load rating, N
- v — Oil viscosity at operating temperature, mm²/s
- n — Speed, r/min
- d_m — Mean diameter of bearing $d_m = 0.5(d+D)$, mm
- ka — Minimum axial load factor (see Table 1)
- kr — Minimum radial load factor (see Table 1)

Table 1

Bearing Series	ka	kr
72	1.4	95
73	1.6	
Qj2	1	100
Qj3	1.1	

When bearings are started at low ambient temperatures or in the condition that the viscosity of lubricant is very high, a larger minimum load is needed. Usually, the weight of bearing supporting parts plus the load on the bearing should be over the minimum load. If the weight can not be up to the minimum load, then extra radial load must be

imposed on this type of bearing in order to meet the requirement of minimum load. For single-row angular contact ball bearing and angular contact ball bearing arranged in tandem, the requirement can be met through adjusting the axial relative position of inner ring and outer ring, or preloading in axial with springs.

Dimension, Tolerance, Clearance

The boundary dimension of the LYC's standard angular contact ball bearing comply with GB/273.3 <Rolling Bearing, Radial Bearing, and Boundary Dimension General Specification>, GB/T292 <Rolling Bearing, Angular Contact Ball Bearing, and Boundary Dimension>, GB/T294 <Rolling Bearing, Three and Four Points Angular Contact Ball Bearing, and Boundary Dimension>, GB/T296 <Rolling Bearing, Double-Row Angular Contact Ball Bearing, and Boundary Dimension>.

The tolerance of the LYC's standard angular contact ball bearing comply with GB/T307.1 <Rolling Bearing, Radial Bearing, and Tolerance>. The clearance of the LYC's angular contact ball bearing is controlled by LYC's internal standards. The dimensional tolerance of the LYC's standard angular contact ball bearing is the normal grade P0. If customers have other special requirements on dimension, tolerance, and clearance, then LYC have the ability to supply the corresponding products, including non-standard products.

Equivalent Dynamic Load

Depending on different structures and contact angles, the equivalent dynamic loads of angular contact ball bearings can be obtained from Table 2.

Table 2

Contact Angles or Structures	Arrangement Mode	Equivalent Dynamic Load
15°	single bearings arranged in tandem	$F_a / Fr \leq e$ $P = Fr$ $F_a / Fr > e$ $P = 0.44Fr + YFa$
	back-to-back arrangement face-to-face arrangement	$F_a / Fr \leq e$ $P = Fr + Y_1Fa$ $F_a / Fr > e$ $P = 0.72Fr + Y_2Fa$
25°	single bearings arranged in tandem	$F_a / Fr \leq 0.68$ $P = Fr$ $F_a / Fr > 0.68$ $P = 0.41Fr + 0.87Fa$
	back-to-back arrangement face-to-face arrangement	$F_a / Fr \leq 0.68$ $P = Fr + 0.92Fa$ $F_a / Fr > 0.68$ $P = 0.67Fr + 1.41Fa$
40°	single bearings arranged in tandem	$F_a / Fr \leq 1.14$ $P = Fr$ $F_a / Fr > 1.14$ $P = 0.35Fr + 0.57Fa$
	back-to-back arrangement face-to-face arrangement	$F_a / Fr \leq 1.14$ $P = Fr + 0.55Fa$ $F_a / Fr > 1.14$ $P = 0.55Fr + 0.93Fa$
Four-Point Contact Ball Bearing		$F_a / Fr \leq 0.95$ $P = Fr + 0.66Fa$ $F_a / Fr > 0.95$ $P = 0.6Fr + 1.07Fa$
Double-Row Angular Contact Ball Bearing		$F_a / Fr \leq 0.8$ $P = Fr + 0.78Fa$ $F_a / Fr > 0.8$ $P = 0.63Fr + 1.24Fa$

Values of e , Y , Y_1 , Y_2 in the above table should be chosen from Table 3.

Table 3

F_a / C_o	e	Y	Y_1	Y_2
0.015	0.38	1.47	1.65	2.39
0.029	0.4	1.4	1.57	2.28
0.058	0.43	1.3	1.46	2.11
0.087	0.46	1.23	1.38	2
0.12	0.47	1.19	1.34	1.93
0.17	0.5	1.12	1.26	1.82
0.29	0.55	1.02	1.14	1.66
0.44	0.56	1	1.12	1.63
0.58	0.56	1	1.12	1.63

Note: C_o is the basic static load rating for a single bearing.

Equivalent Static Load

Depending on different structures and contact angles, the equivalent static loads of angular contact ball bearings can be obtained from Table 4.

Table 4

Contact Angles or Structures	Arrangement Mode	Equivalent Static Load
15°	single bearings arranged in tandem	normal $P_0 = 0.5Fr + 0.46Fa$ $P_0 = Fr$
	back-to-back arrangement face-to-face arrangement	$P_0 = Fr + 0.92Fa$
25°	single bearing arranged in tandem	normal $P_0 = 0.5Fr + 0.38Fa$ $P_0 = Fr$
	back-to-back arrangement face-to-face arrangement	$P_0 = Fr + 0.76Fa$
40°	single bearings arranged in tandem	normal $P_0 = 0.5Fr + 0.26Fa$ $P_0 = Fr$
	back-to-back arrangement face-to-face arrangement	$P_0 = Fr + 0.52Fa$
Four-Point Contact Ball Bearing		$P_0 = Fr + 0.58Fa$
Double-Row Angular Contact Ball Bearing		$P_0 = Fr + 0.66Fa$

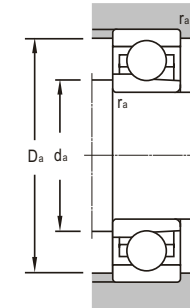
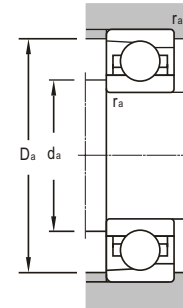
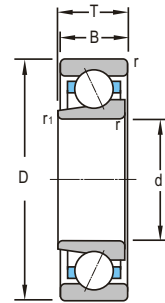
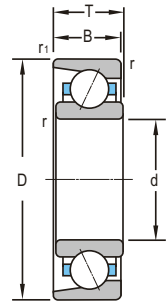

d 5~25mm

Boundary Dimensions							Basic Load Ratings		Limiting Speeds	
d	D	B	T _{max}	T _{min}	r _{min}	r _{1min}	Dynamic C	Static C ₀	Grease	Oil
mm							kN		r/min	
5	37	18.23	18.23	18.03	0.3	0.15	6.61	4.05		
10	26	8	8	7.8	0.3	0.15	4.92	2.21	19000	28000
	26	8	8	7.8	0.3	0.15	4.75	2.14	19000	28000
	30	9	9	8.8	0.6	0.15	5.81	2.93	18000	26000
12	30	9	9	8.8	0.6	0.15	5.59	2.85	18000	26000
	28	8	8	7.7	0.3	0.15	5.41	2.6	18000	26000
	28	8	8	7.7	0.3	0.2	5.41	2.6	18000	26000
15	32	10	10	9.7	0.6	0.15	7.33	3.43	17000	24000
	32	10	10	9.7	0.6	0.15	7.09	3.33	17000	24000
	32	10	10	9.7	0.3	0.15	5.41	2.6	18000	26000
17	32	9	9	8.7	0.3	0.15	6.24	3.39	17000	24000
	32	9	9	8.7	0.3	0.15	5.97	3.24	17000	24000
	32	9	9	8.7	0.3	0.2	6.24	3.39	16000	22000
	35	11	11	10.7	0.6	0.15	8.68	4.57	16000	22000
	35	11	11	10.7	0.6	0.15	8.35	4.39	16000	22000
20	35	10	10	9.7	0.3	0.15	6.61	3.81	16000	22000
	35	10	10	9.7	0.3	0.15	8.23	4.53	16000	22000
	35	10	10	9.7	0.3	0.15	6.3	3.65	16000	22000
	35	10	10	9.7	0.3	0.2	6.61	3.81	16000	22000
	40	12	12	11.7	0.6	0.3	10.8	6.13	15000	20000
	40	12	12	11.7	0.6	0.3	10.5	5.65	15000	20000
	40	12	12	11.7	0.6	0.3	10.8	6.13	15000	20000
	40	12	12	11.7	0.6	0.3	10.5	5.65	15000	20000
25	42	12	12	11.7	0.6	0.15	10.5	6.02	14000	19000
	42	12	12	11.7	0.6	0.15	10	5.74	14000	19000
	42	12	12	11.7	0.6	0.2	10.5	6.02	14000	19000
	47	14	14	13.7	1	0.3	15.5	8.91	13000	18000
	47	14	14	13.7	1	0.3	15	8.54	13000	18000
	47	14	14	13.7	1	0.3	14.1	7.81	13000	18000
	47	14	14	13.9	1	0.6	11.7	22.6	12000	16000
	52	15	15	14.6	1.1	0.6	16.2	8.71	12000	17000
25	47	12	12	11.7	0.6	0.15	12.9	8.58	12000	17000
	47	12	12	11.7	0.6	0.15	11.1	7.08	12000	17000
	47	12	12	11.7	0.6	0.2	12.9	8.58	12000	17000
	52	15	15	14.7	1	0.3	16.6	9.18	11000	16000
	52	15	15	14.7	1	0.3	15.9	9.81	11000	16000

Bearing Designations		Mounting Dimensions				Mass
Present	Original	d _a	D _a	r _a	r _{a1}	
		mm				kg
71904AC/P4YA			31	0.3	0.15	0.0879
7000C	36100	12.4	23.6	0.3	0.15	0.018
7000AC	46100	12.4	23.6	0.3	0.15	0.018
7200C	36200	15	25	0.6	0.15	0.03
7200AC	46200	15	25	0.6	0.15	0.03
7001C	36101	14.4	25.6	0.3	0.15	0.02
7001AC	46101	14.4	25.6	0.3	0.15	0.02
B7001C	136101	14.4	25.6	0.3	0.2	0.0205
7201C	36201	17	27	0.6	0.15	0.035
7201AC	46201	17	27	0.6	0.15	0.035
7002C	36102	17.4	29.6	0.3	0.15	0.028
7002AC	46102	17.4	29.6	0.3	0.15	0.028
B7002C	136102	17.4	29.6	0.3	0.2	0.0296
7202C	36202	20	30	0.6	0.15	0.043
7202AC	46202	20	30	0.6	0.15	0.043
7003C	36103	19.4	32.6	0.3	0.15	0.036
SN7003	106103	19.4	32.6	0.3	0.15	0.0452
7003AC	46103	19.4	32.6	0.3	0.15	0.036
B7003C	136103	19.4	32.6	0.3	0.2	0.0402
7203C	36203	22	35	0.6	0.3	0.0636
7203AC	46203	22	35	0.6	0.3	0.0636
B7203C	136203	22	35	0.6	0.3	0.0537
7004C	36104	25	37	0.6	0.15	0.064
7004AC	46104	25	37	0.6	0.15	0.064
B7004C	136104	25	37	0.6	0.2	0.0712
7204C	36204	26	42	1	0.3	0.1
7204AC	46204	26	42	1	0.3	0.1
7204B	66204	26	42	1	0.3	0.11
760204 TN1/P4		26	44	1	0.6	0.177
7304B	66304	27	47	1	0.6	0.177
7005C	36105	30	42	0.6	0.15	0.074
7005AC	46105	30	42	0.6	0.15	0.074
B7005C	136105	30	42	0.6	0.2	0.077
7205C	36205	36	46	1	0.3	0.122
7205AC	46205	36	46	1	0.3	0.122

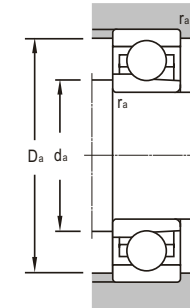
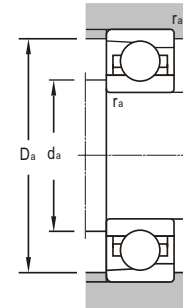
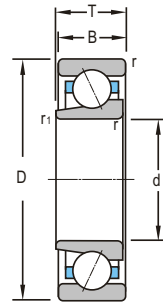
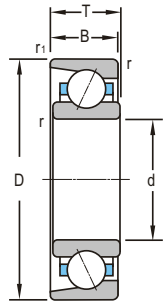

d 25~45mm

Boundary Dimensions							Basic Load Ratings		Limiting Speeds		
d	D	B	T _{max}	T _{min}	r _{min}	r _{1min}	Dynamic C	Static C ₀	Grease	Oil	
mm							kN		r/min		
25	52	15	15	14.7	1	0.3	15.8	9.37	11000	16000	
	62	15	15	14.9	1	0.6	9.3	6.7	8000	12000	
	62	17	17	16.6	1.1	0.6	29.9	17.2	9500	14000	
	62	17	17	16.6	1.1	0.6	28.9	16.7	9500	14000	
30	55	13	13	12.7	1	0.3	15.1	10.3	9500	14000	
	55	13	13	12.7	1	0.3	14.4	9.83	9500	14000	
	55	13	13	12.7	1	0.3	15.1	10.3	9500	14000	
	62	16	16	15.7	1	0.3	23	14.7	9000	13000	
	62	16	16	15.7	1	0.3	22.1	14.1	9000	13000	
	62	16	16	15.7	1	0.3	21.9	12.5	9000	13000	
	62	16	16	15.7	1	0.3	23	14.7	9500	14000	
	72	19	19	18.6	1.1	0.6	35.9	22.3	8500	12000	
	72	19	19	18.6	1.1	0.6	34.6	21.4	8500	12000	
	72	19	19	18.6	1.1	0.6	31.1	19.3	8500	12000	
35	62	14	14	13.7	1	0.3	16.3	12.1	8500	12000	
	62	14	14	13.7	1	0.3	15.5	11.5	8500	12000	
	62	14	14	13.7	1	0.3	16.3	12.1	8500	12000	
	72	17	17	16.7	1.1	0.6	32.1	22	8000	11000	
	72	17	17	16.7	1.1	0.6	30.7	20.7	9000	12000	
	72	17	17	16.7	1.1	0.6	27.1	18.4	8000	11000	
	80	21	21	20.6	1.5	0.6	44.1	28	7500	10000	
	80	21	21	20.6	1.5	0.6	42.5	27	7500	10000	
	80	21	21	20.6	1.5	0.6	38.1	24.2	7500	10000	
	100	25	25	24.6	1.5	0.6	70	42.2	6300	8500	
40	62	21.1	21.1	20.9	0.6	0.3	13.7	11.1	9000	12000	
	68	15	15	14.7	1	0.3	20.1	15.2	8000	11000	
	68	15	15	14.7	1	0.3	19	14.4	8000	11000	
	68	15	15	14.7	1	0.3	18.4	14.3	8000	11000	
	80	18	18	17.7	1.1	0.6	36.9	25.6	7500	10000	
	80	18	18	17.7	1.1	0.6	35.2	24.4	7500	10000	
	80	18	18	17.7	1.1	0.6	32.6	23.4	7500	10000	
	90	23	23	22.6	1.5	0.6	53.8	35	6700	9000	
	90	23	23	22.6	1.5	0.6	51.8	33.8	6700	9000	
	90	23	23	22.6	1.5	0.6	46.4	30.3	6700	9000	
	110	27	27	26.6	2	1	73.6	49.7	6000	8000	
	110	27	27	26.6	2	1	57.2	45.3	6000	8000	
	45	75	16	16	15.7	1	0.3	25.9	20.4	7500	10000

Bearing Designations		Mounting Dimensions				Mass
Present	Original	d _a	D _a	r _a	r _{a1}	kg
		mm				kg
7205B 760305 X2TN1/P4	66205	36	46	1	0.3	0.13
		31	56	1	0.6	0.236
	36305	37	57	1	0.6	0.23
	46305	37	57	1	0.6	0.23
7006C 7006AC B7006C 7206C 7206AC 7206B B7206C 7306C 7306AC 7306B	36106	36	49	1	0.3	0.11
	46106	36	49	1	0.3	0.11
	136106	36	49	1	0.3	0.117
	36206	36	56	1	0.3	0.198
	46206	36	56	1	0.3	0.198
	66206	36	56	1	0.3	0.21
	136206	36	56	1	0.3	0.2
	36306	37	65	1	0.6	0.35
	46306	37	65	1	0.6	0.35
	66306	37	65	1	0.6	0.37
7007C 7007AC B7007C 7207C 7207AC 7207B 7307C 7307AC 7307B 7407AC	36107	41	56	1	0.3	0.15
	46107	41	56	1	0.3	0.15
	136107	41	56	1	0.3	0.144
	36207	42	65	1.1	0.6	0.305
	46207	42	65	1.1	0.6	0.305
	66207	42	65	1.1	0.6	0.3
	36307	44	71	1.5	0.6	0.47
	46307	44	71	1.5	0.6	0.47
	66307	44	71	1.5	0.6	0.51
	46407	44	91	1.5	0.6	0.933
71908AC/P4YA 7008C 7008AC B7008C 7208C 7208AC 7208B 7308C 7308AC 7308B 7408AC 7408B		46	66	0.6	0.3	0.17
	36108	46	62	1	0.3	0.18
	46108	46	62	1	0.3	0.18
	136108	46	62	1	0.3	0.208
	36208	47	73	1	0.6	0.369
	46208	47	73	1	0.6	0.369
	66208	47	73	1	0.6	0.39
	36308	49	81	1.5	0.6	0.673
	46308	49	81	1.5	0.6	0.629
	66308	49	81	1.5	0.6	0.67
7408AC 7408B	46408	50	100	2	1	1.41
	66408	50	100	2	1	1.4
7009C	36109	51	69	1	0.3	0.23

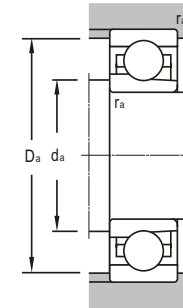
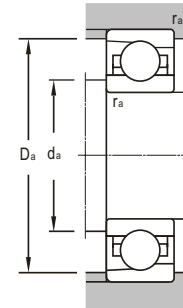
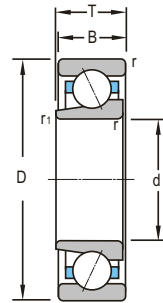
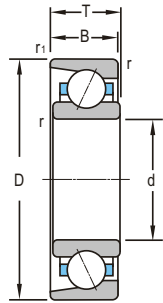

d 45~60mm

Boundary Dimensions							Basic Load Ratings		Limiting Speeds	
d	D	B	T _{max}	T _{min}	r _{min}	r _{1min}	Dynamic C	Static C ₀	Grease	Oil
mm							kN		r/min	
45	75	16	16	15.7	1	0.3	24.5	19.3	7500	10000
	75	16	16	15.7	1	0.3	25.9	20.4	7500	10000
	85	19	19	18.7	1.1	0.6	38.6	29	12000	17000
	85	19	19	18.7	1.1	0.6	36.9	27.1	6700	9000
	85	19	19	18.7	1.1	0.6	36	26.3	6700	9000
	100	25	25	24.6	1.5	0.6	66.8	45.8	6000	8000
	100	25	25	24.6	1.5	0.6	66.4	44	6000	8000
	100	25	25	24.6	1.5	0.6	59.7	39.7	6000	8000
	120	29	29	28.6	2	1	87	55	5300	7000
	50	80	16	16	15.7	1	0.3	26.6	21.9	6700
80		16	16	15.7	1	0.3	25.2	21.4	6700	9000
80		16	16	15.7	1	0.3	26.6	21.9	6700	9000
90		20	20	19.7	1.1	0.6	42.8	32	7600	10000
90		20	20	19.7	1.1	0.6	40.8	30.3	6300	8500
90		20	20	19.7	1.1	0.6	37.4	29	6300	8500
110		27	27	26.6	2	1	79.5	55.9	7000	8700
110		27	27	26.6	2	1	76.5	53.8	5600	7500
110		27	27	26.6	2	1	68.2	48	5600	7500
55		90	18	18	17.7	1.1	0.6	37.2	28.6	6000
	90	18	18	17.7	1.1	0.6	35.2	27.2	1000	12000
	100	21	21	20.6	1.5	0.6	53	40	8000	10000
	100	21	21	20.6	1.5	0.6	50.5	38.2	7100	10000
	100	21	21	20.6	1.5	0.6	46.3	36.1	5600	7500
	120	29	29	28.5	2	1	91.8	65.6	7000	8700
	120	29	29	28.5	2	1	88.3	63.2	5000	6700
	120	29	29	28.5	2	1	78.7	56.4	5000	6700
	120	29	29	28.5	2	2	127	108	7000	8700
	60	95	18	18	17.7	1.1	0.6	38.2	32.6	5600
95		18	18	17.7	1.1	0.6	36.2	31.6	5600	7500
110		22	22	21.6	1.5	0.6	61	48.3	5300	7000
110		22	22	21.6	1.5	0.6	58.2	46	5300	7000
110		22	22	21.6	1.5	0.6	56.1	44.4	5300	7000
130		31	31	30.5	2.1	1.1	105	76.3	4800	6300
130		31	31	30.5	2.1	1.1	101	73.4	4800	6300
130		31	31	30.5	2.1	1.1	101	73.5	4800	6300
130		31	31	30.5	2.1	1.1	90	65.5	4800	6300
150		35	35	34.4	2.1	1.1	132	95.3	4300	5600
150		35	35	34.4	2.1	1.1	118	86.3	4300	5600

Bearing Designations		Mounting Dimensions				Mass
Present	Original	d _a	D _a	r _a	r _{a1}	
		mm				kg
7009AC	46109	51	69	1	0.3	0.23
B7009C	136109	51	69	1	0.3	0.238
7209C	36209	52	78	1	0.6	0.407
7209AC	46209	52	78	1	0.6	0.41
7209B	66209	52	78	1	0.6	0.44
7309C	36309	54	91	1.5	0.6	0.86
7309AC	46309	54	91	1.5	0.6	0.86
7309B	66309	54	91	1.5	0.6	0.9
7409AC	46409	55	110	2	1	1.77
7010C	36110	56	74	1	0.3	0.25
7010AC	46110	56	74	1	0.3	0.257
B7010C	136110	56	74	1	0.3	0.26
7210C	36210	57	83	1	0.6	0.454
7210AC	46210	57	83	1	0.6	0.46
7210B	66210	57	83	1	0.6	0.49
7310C	36310	60	100	2	1	1.08
7310AC	46310	60	100	2	1	1.32
7310B	66310	60	100	2	1	1.15
7011C	36111	62	83	1	0.6	0.38
7011AC	46111	62	83	1	0.6	0.381
7211C	36211	64	91	1.5	0.6	0.61
7211AC	46211	64	91	1.5	0.6	0.61
7211B	66211	64	91	1.5	0.6	0.65
7311C	36311	65	110	2	1	1.71
7311AC	46311	65	110	2	1	1.42
7311B	66311	65	110	2	1	1.45
QJ311M		65	110	2	2	1.73
7012C	36112	67	88	1	0.6	0.4
7012AC	46112	67	88	1	0.6	0.4
7212C	36212	69	101	1.5	0.6	0.8
7212AC	46212	69	101	1.5	0.6	0.8
7212B	66212	69	101	1.5	0.6	0.84
7312C	36312	72	118	2.1	1	1.7
7312AC	46312	72	118	2.1	1	2.06
7312ACJ		72	118	2.1	1.1	1.77
7312B	66312	72	118	2.1	1	1.85
7412AC	46412	72	118	2.1	1	3.55
7412B	66412	72	118	2.1	1	3.56

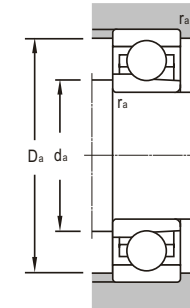
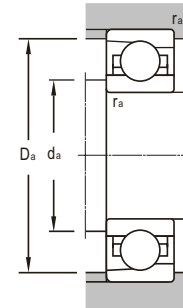
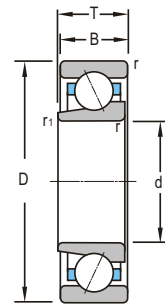
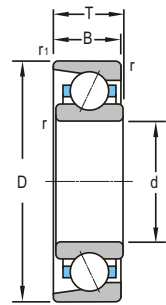

d 65~80mm

Boundary Dimensions							Basic Load Ratings		Limiting Speeds		
d	D	B	T _{max}	T _{min}	r _{min}	r _{1min}	Dynamic C	Static C ₀	Grease	Oil	
mm							kN		r/min		
65	100	18	18	17.7	1.1	0.6	40.1	35.4	5300	7000	
	100	18	18	17.7	1.1	0.6	38	34.1	5300	7000	
	120	23	23	22.6	1.5	0.6	70	54.8	4800	6300	
	120	23	23	22.6	1.5	0.6	66.6	52.3	4800	6300	
	120	23	23	22.6	1.5	0.6	63.4	46	4800	6300	
	140	33	33	32.5	2.1	1.1	121	88.9	4300	5600	
	140	33	33	32.5	2.1	1.1	116	85.5	4300	5600	
	140	33	33	32.5	2.1	1.1	103	76.3	4300	5600	
	140	23	23	22.6			66.6	52.3	4800	6300	
	70	110	20	20	19.7	1.1	0.6	48.3	43.2	500	6700
110		20	20	19.7	1.1	0.6	45.7	42.7	5000	6700	
110		20	20	19.7	1.1	0.7	45.7	42.7	5000	6700	
125		24	24	23.6	1.5	0.6	72.9	65	4500	6200	
125		24	24	23.6	1.5	0.6	75.8	62	4500	6200	
125		24	24	23.6	1.5	0.6	61.6	54	4500	6200	
150		35	35	34.5	2.1	1.1	134	100	4000	5300	
150		35	35	34.5	2.1	1.1	129	96.3	4000	5300	
150		35	35	34.5	2.1	1.1	114	86	4000	5300	
180		42	42	41.4	3	1.1	150	131	3600	4800	
75	115	20	20	19.7	1.1	0.6	49.5	45	4800	6300	
	115	20	20	19.7	1.1	0.6	46.8	45.8	4800	6300	
	130	25	25	24.6	1.5	0.6	79.2	63.7	4300	5600	
	130	25	25	24.6	1.5	0.6	78.8	67	4300	5600	
	130	25	25	24.6	1.5	0.6	72.8	61.6	4300	5600	
	160	37	37	36.5	2.1	1.1	145	113	3800	5000	
	160	37	37	36.5	2.1	1.1	139	109	3800	5000	
	160	37	37	36.5	2.1	1.1	124	97.2	3800	5000	
	80	125	22	22	21.7	1.1	0.6	58.5	56.8	4500	6000
		125	22	22	21.7	1.1	0.6	55.4	55.1	4500	6000
140		26	26	25.6	2	1	92.8	83	4000	5300	
140		26	26	25.6	2	1	88.4	79	4000	5300	
140		26	26	25.6	2	1	80.5	69.2	4000	5300	
140		21	26.5				75.2	64.6	3600	4800	
170		39	39	38.5	2.1	1.1	158	128	3600	4800	
170		39	39	38.5	2.1	1.1	152	122	3600	4800	
170		39	39	38.5	2.1	1.1	135	109	3600	4800	
200		48	48	47.4	3	1.1	182	170	3200	4300	

Bearing Designations		Mounting Dimensions				Mass
Present	Original	d _a	D _a	r _a	r _{a1}	
		mm				kg
7013C	36113	72	93	1	0.6	0.43
7013AC	46113	72	93	1	0.6	0.43
7213C	36213	74	111	1.5	0.6	1
7213AC	46213	74	111	1.5	0.6	1
7213B	66213	74	111	1.5	0.6	1.05
7313C	36313	77	118	2.1	1	2.23
7313AC	46313	77	118	2.1	1	2.23
7313B	66313	77	118	2.1	1	2.25
7213ACN2						1.12
7014C	36114	77	103	1	0.6	0.6
7014AC	46114	77	103	1	0.6	0.6
B7014AC	146114	77	103	1	0.7	0.587
7214C	36214	79	114	1.5	0.6	1.1
7214AC	46214	79	114	1.5	0.6	1.1
7214B	66214	79	114	1.5	0.6	1.15
7314C	36314	82	138	2.1	1	2.67
7314AC	46314	82	138	2.1	1	3.06
7314B	66314	82	138	2.1	1	2.75
7414AC	46414	84	166	2.5	1	5.22
7015C	36115	82	108	1	0.6	0.63
7015AC	46115	82	108	1	0.6	0.671
7215C	36215	84	121	1.5	0.6	1.29
7215AC	46215	84	121	1.5	0.6	1.2
7215B	66215	84	121	1.5	0.6	1.3
7315C	36315	87	148	2.1	1.1	3.56
7315AC	46315	87	148	2.1	1.1	3.56
7315B	66315	87	148	2.1	1.1	3.3
7016C	36116	87	118	1	0.6	0.85
7016AC	46116	87	118	1	0.6	0.85
7216C	36216	90	130	2	1	1.45
7216AC	46216	90	130	2	1	1.43
7216B	66216	90	130	2	1	1.55
S7216X2WB1J						1.33
7316C	36316	92	158	2.1	1	3.59
7316AC	46316	92	158	2.1	1	3.59
7316B	66316	92	158	2.1	1	3.9
7416AC	46416	94	186	2.5	1	8.72

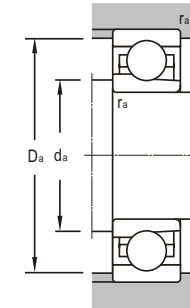
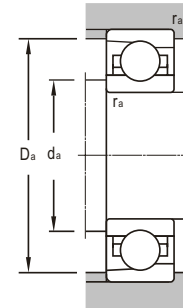
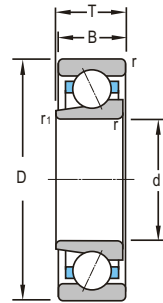
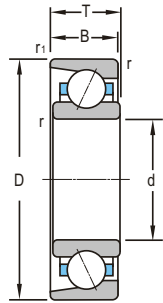

d 85~105mm

Boundary Dimensions							Basic Load Ratings		Limiting Speeds	
d	D	B	T _{max}	T _{min}	r _{min}	r _{1min}	Dynamic C	Static C ₀	Grease	Oil
mm							kN		r/min	
85	130	22	22	21.5	1.1	0.6	62.5	61.7	4300	5600
	130	22	22	21.5	1.1	0.6	59.2	59.2	4300	5600
	150	28	28	27.5	2	1	99.7	90	3800	5000
	150	28	28	27.5	2	1	94.9	86	3800	5000
	150	28	28	27.5	2	1	93.1	81	3800	5000
	180	41	41	40.2	3	1.1	172	141	3400	4500
	180	41	41	40.2	3	1.1	165	137	3400	4500
180	41	41	40.2	3	1.1	148	122	3400	4500	
90	140	24	24	23.5	1.5	0.6	71.4	71.7	4000	5300
	140	24	24	23.5	1.5	0.6	67.6	68.6	4000	5300
	160	30	30	29.5	2	1	123	105	3600	4800
	160	30	30	29.5	2	1	117	100	3600	4800
	160	30	30	29.5	2	1	106	93.8	3600	4800
	160	30	30	29.5	2	1	113	96.8	3600	4800
	190	43	43	42.2	3	1.1	185	160	3200	4300
	190	43	43	42.2	3	1.1	178	154	3200	4300
	190	43	43	42.2	3	1.1	158	137	3200	4300
	225	54	54	53.4	4	1.5	233	214	2600	3600
95	145	24	24	23.5	1.5	0.6	73.6	77.1	3800	5000
	145	24	24	23.5	1.5	0.6	69.5	71	3800	5000
	170	32	32	31.5	2.1	1.1	135	120	3400	4500
	170	32	32	31.5	2.1	1.1	128	114	3400	4500
	170	32	32	31.5	2.1	1.1	121	108	3400	4500
	200	45	45	44.2	3	1.1	201	180	3000	4000
	200	45	45	44.2	3	1.1	193	173	3000	4000
	200	45	45	44.2	3	1.1	172	154	3000	4000
97	120	13.5	13.5	13.2	1	0.3	19	22.1	4000	5200
100	150	24	24	23.5	1.5	0.6	79.4	81.3	3800	5000
	150	24	24	23.5	1.5	0.6	75.1	77	3800	5000
	180	34	34	33.5	2.1	1.1	149	136	3200	4300
	180	34	34	33.5	2.1	1.1	142	130	3200	4300
	180	34	34	33.5	2.1	1.1	130	114	3200	4300
	215	47	47	46.2	3	1.1	222	207	2600	3600
	215	47	47	46.2	3	1.1	214	199	2600	3600
215	47	47	46.2	3	1.1	190	177	2600	3600	
105	160	26			2	2	124	156		

Bearing Designations		Mounting Dimensions				Mass
Present	Original	d _a	D _a	r _a	r _{a1}	
		mm				kg
7017C	36117	92	123	1	0.6	0.89
7017AC	46117	92	123	1	0.6	0.89
7217C	36217	95	140	2	1	1.8
7217AC	46217	95	140	2	1	1.8
7217B	66217	95	140	2	1	1.95
7317C	36317	99	166	2.5	1	4.38
7317AC	46317	99	166	2.5	1	4.38
7317B	66317	99	166	2.5	1	4.6
7018C	36118	99	131	1.5	0.6	1.15
7018AC	46118	99	131	1.5	0.6	1.15
7218C	36218	100	150	2	1	2.18
7218AC	46218	100	150	2	1	2.19
7218B	66218	100	150	2	1	2.4
7218AC/YB		100	150	2	1	2.71
7318C	36318	104	176	2.5	1	4.87
7318AC	46318	104	176	2.5	1	5.06
7318B	66318	104	176	2.5	1	5.4
7418AC	46418	108	207	3	1.5	12.2
7019C	36119	104	136	1.5	0.6	1.2
7019AC	46119	104	136	1.5	0.6	1.2
7219C	36219	107	158	2.1	1	2.7
7219AC	46219	107	158	2.1	1	2.7
7219B	66219	107	158	2.1	1	2.9
7319C	36319	109	186	2.5	1	5.98
7319AC	46319	109	186	2.5	1	5.98
7319B	66319	109	186	2.5	1	6.25
LY-7040		104	114	1	0.3	0.278
7020C	36120	109	141	1.5	0.6	1.25
7020AC	46120	109	141	1.5	0.6	1.25
7220C	36220	112	168	2.1	1	3.28
7220AC	46220	112	168	2.1	1	3.25
7220B	66220	112	168	2.1	1	3.45
7320C	36320	114	201	2.5	1	7.2
7320AC	46320	114	201	2.5	1	8.47
7320B	66320	114	201	2.5	1	7.75
QJ 1021 MA/P5 YB		115	150	2	2	2.01

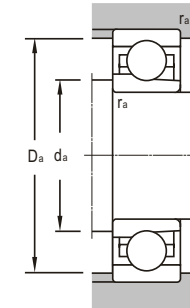
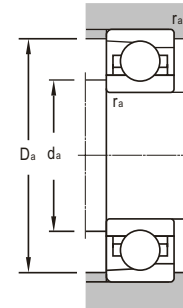
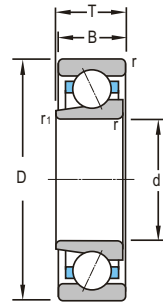
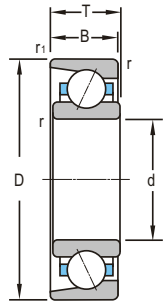

d 110~270mm

Boundary Dimensions							Basic Load Ratings		Limiting Speeds	
d	D	B	T _{max}	T _{min}	r _{min}	r _{1min}	Dynamic C	Static C ₀	Grease	Oil
mm							kN		r/min	
110	170	28	28	27.5	2	1	104	104	2800	3800
	200	38	38	37.5	2.1	1.1	176	171	2800	3800
	200	38	38	37.5	2.1	1.1	176	164	2800	3800
	200	38	38	37.5	2.1	1.1	165	161	2800	3800
	240	50	50	49.2	3	1.1	253	252	2200	3200
	240	50	50	49.2	3	1.1	226	225	2200	3200
120	165	22	22	21.5	1.1	0.6	51.2	52.2	2200	3200
	215	40	40	39.5	2.1	1.1	190	179	2400	3400
	215	40	40	39.5	2.1	1.1	181	184	2400	3400
	215	40	40	39.5	2.1	1.1	193	262	2400	3400
	260	55	55	54.2	3	1.1	279	288	2200	3200
	260	55	55	54.2	3	1.1	268	277	2200	3200
130	230	40	40	39.5	2.1	1.1	180	200	2500	3200
140	210	33	33	32.5	2	1	140	150	2600	3300
	300	62	62	61.2	4	1.5	290	334	2000	2500
150	320	65	65	64.2	4	1.5	340	429	2000	2800
159	191	16.5	16.5	16.2	1.1	0.6	42.6	59.8	1800	3000
160	290	48	48	47.2	3	1.1	256	295	1600	2200
	290	48			3	3	391	550		
180	320	52	52	51.2	4	1.5	302	399	1500	2000
185	215	15	15	14.5	1.1	0.3	25.8	40.3	2000	3000
190	260	33	33	32.5	2	1.1	139	177	1800	2200
220	400	65	65	64.2	4	1.5	358	605	1100	1600
	300	38	38	37.5	2.1	1.1	143	201	1500	2000
240	500	95	95	94	5	2	515	801	800	1100
260	360	46	46	45.2	2.1	1.1	212	302	1300	1600
	320	28	28	27.5	2	1	104	166	1400	1900
270	330	30	30	29.5	2.1	1.1	90.8	114	1300	1700

Bearing Designations		Mounting Dimensions				Mass
Present	Original	d _a	D _a	r _a	r _{a1}	
		mm				kg
7022AC	46122	120	160	2	1	2.46
7222C	36222	122	188	2.1	1	4.55
7222AC	46222	122	188	2.1	1	4.55
7222B	66222	122	188	2.1	1	4.8
7322AC	46322	124	226	2.5	1	10.7
7322B	66322	124	226	2.5	1	10.7
71924C	1036924	127	158	1	0.6	1.51
7224C	36224	132	203	2.1	1	5.4
7224AC	46224	132	203	2.1	1	5.4
7224B	66224	132	203	2.1	1	6.13
7324C	36324	134	246	2.5	1	14.8
7324AC	46324	134	246	2.5	1	14.8
7226AC	46226	142	218	2.1	1.1	7.46
7028AC	46128	150	200	2	1	3.77
7328B	66328	158	282	3	1.5	23
7330AC	46330	168	302	3	1.5	27
LY-7041		168	182	1.1	0.6	0.749
7232AC		174	276	2.5	1	14.6
QJ232N2MA/C3		174	276	2.5	2.5	15
7236AC		198	302	3	1.5	18.9
LY-7049		199	209	1.1	0.3	0.941
71938AC	1046938	180	250	2	1	4.45
7244AC	46244	238	382	3	1.5	38.5
71944C		232	288	2.1	1	7.35
7348B		262	478	4	2	
71952B	1066952	272	348	2.1	1	14.3
71852C		270	310	2	1	4.78
7654B	66754	282	318	2.1	1	5.75

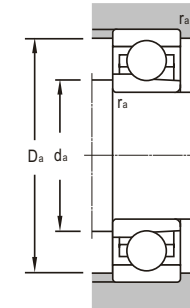
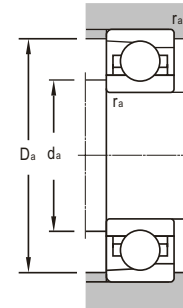
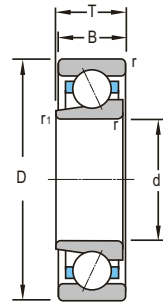
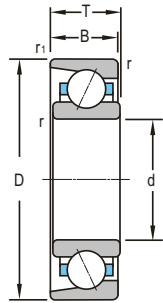

d 300~1000mm

Boundary Dimensions							Basic Load Ratings		Limiting Speeds	
<i>d</i>	<i>D</i>	<i>B</i>	<i>T_{max}</i>	<i>T_{min}</i>	<i>r_{min}</i>	<i>r_{1min}</i>	Dynamic <i>C</i>	Static <i>C₀</i>	Grease	Oil
mm							kN		r/min	
300	540	85	85	84.2	5	3	396	890	800	1000
340	460	56	56	55.2	3	1.1	306	503	800	1000
360	540	82	82	81.6	5	2	488	878	1300	1300
380	440	25	25	24.6	3	1	110	178	960	1200
	520	82	82	81.2	4	1.5	407	733	700	900
	560	82	82		5	5	813	1890	720	950
420	560	65	65	64.2	3	1.1	451	652	600	800
435	485.8	25.4	25.4	25.15	1.5	1.5	46.2	85.2	750	950
460	540	35	35		2.1	1.5	139	272	720	900
	580	56	56		3	2	303	559	670	830
	600	50	50	49	3	1.5	284	522	600	800
	620	74	74	73.2	4	1.5	439	865	550	750
530	710	82	82	81.2	5	2.1	541	1136	500	700
	760	100	100	99	6	3	737	1690	500	700
600	730	60	60	59.5	3	2	425	887	380	500
	730	60	60	59.5	3	1.1	425	887	380	500
622.3	725.487	46	46	44	4.5	2	304	652	400	550
630	850	100	100		6	2.1	855	2100	350	440
670	980	136	136	135	7.5	4	1120	2940	280	400
690	850	74	74		4	1.5	488	1140	370	500
750	920	78			5	2	619	1550	280	400
800	980	82	82		5	3	725	1876	250	300
850	1030	82	82		5	3	562	1473	220	280
	1120	90	90		6	3	854	2380	180	260
1000	1220	50	50		4.5	3	409	1178	120	150

Bearing Designations		Mounting Dimensions				Mass
Present	Original	<i>d_a</i>	<i>D_a</i>	<i>r_a</i>	<i>r_{a1}</i>	
		mm				kg
7260B	66260	322	518	4	2.5	72.9
71968B	1066968	354	446	2.5	1	27.5
7072 ACM		380	520	4	1.5	67.1
7676	6776	394	426	2.5	1	7.1
72976AC	2046976	398	502	3	1.5	48.9
QJ1076N2		419	527	4	4	73.1
71984	1046984K	434	546	2.5	1	52.5
LY-Q064		447	470	1	1	5.77
S7692	6792	472	528	2.1		15
S71892AC	1006892	474	566	2.5		36.4
7692AC	46792	474	586	2.5	1.5	37.9
71992B	1066992	478	602	3	1.5	64.1
719/530AC	10469/530	552	688	4	2.1	88.8
LY-7009		558	732	5	2.5	
SN718/600	11068/600	614	716	2.5		60.7
S718/600C		614	716	2.5		60.7
76/662.3RWB1	6169/622	644	702	4		29.58
719/630AC	10469/630	658	822	5	2.1	161
70/670ACM/P5		720	930	6	3	348
LY-7038		724	832	2.5	1.5	88.7
718/750AMB/P6		794	902	4	1.5	113
SN718/800	11068/800	822	958	4		132
SN718/850	11068/850	872	1008	4		146
719/850X2AMB/DT		878	1106	5	2.5	247
SN708/1000X2	1068/1000	1022	1198	4		140



single row, in pairs

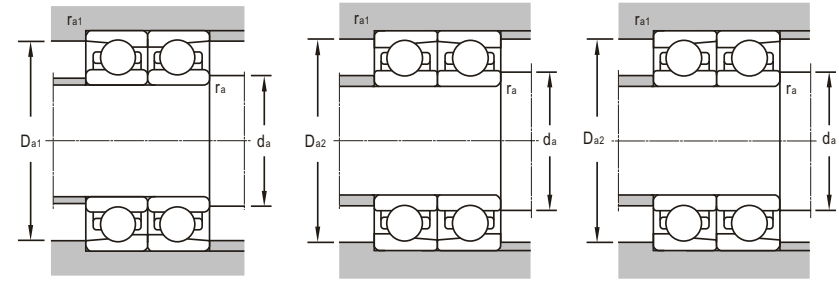
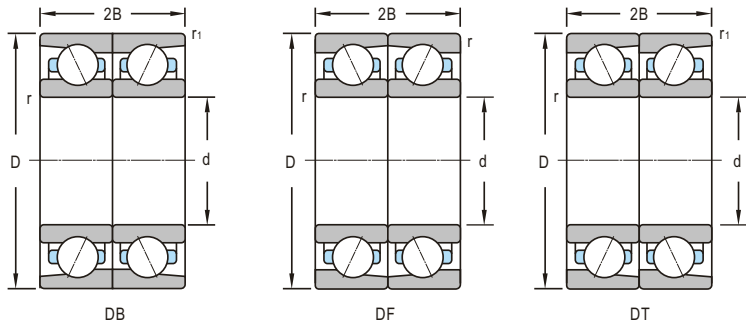

d 10~30mm

d	Boundary Dimensions				Basic Load Ratings		Limiting Speeds	
	D	2B	r _{min}	r _{1min}	Dynamic C	Static C ₀	Grease	Oil
mm								
					kN		r/min	
10	26	16	0.3	0.15	7.99	4.42	14000	20000
	26	16	0.3	0.15	7.72	4.28	14000	20000
	30	18	0.6	0.15	9.44	5.86	13000	18000
	30	18	0.6	0.15	9.08	5.7	13000	18000
12	28	16	0.3	0.15	8.8	5.28	13000	18000
	28	16	0.3	0.15	8.46	5.06	13000	18000
	32	20	0.6	0.15	11.9	6.86	12000	17000
	32	20	0.6	0.15	11.5	6.66	12000	17000
15	32	18	0.3	0.15	10.1	6.78	12000	17000
	32	18	0.3	0.15	9.7	6.48	12000	17000
	35	22	0.6	0.15	14.1	9.14	11000	15000
	35	22	0.6	0.15	13.6	8.78	11000	15000
17	35	20	0.3	0.15	10.7	7.62	11000	15000
	35	20	0.3	0.15	10.2	7.3	11000	15000
	40	24	0.6	0.3	17.5	12.3	10000	14000
	40	24	0.6	0.3	17.1	11.3	10000	14000
20	42	24	0.6	0.15	17.1	12	9500	13000
	42	24	0.6	0.15	16.2	11.5	9500	13000
	47	28	1	0.3	25.2	17.8	9000	12000
	47	28	1	0.3	24.4	17.1	9000	12000
	47	28	1	0.3	22.9	15.6	9000	12000
	47	28	1	0.6	19	13.5	8500	11000
	47	28	1	0.6	19	13.5	8500	11000
	47	28	1	0.6	19	13.5	8500	11000
25	47	24	0.6	0.15	21	17.2	9000	12000
	47	24	0.6	0.15	18	14.2	9000	12000
	52	30	1	0.3	24	18.4	8000	11000
	52	30	1	0.3	25.8	19.6	8000	11000
	52	30	1	0.3	25.7	18.7	8000	11000
	62	34	1.1	0.6	48.6	34.4	6700	10000
	62	34	1.1	0.6	46.9	33.4	6700	10000
	62	34	1.1	0.6	42.6	30.2	6700	10000
30	62	48(3B)	1.1	1	36.9	110.7	6700	10000
	55	26	1	0.3	24.5	20.6	6700	10000
	55	26	1	0.3	23.4	19.7	6700	10000
	62	32	1	0.3	37.4	29.4	6300	9500

	Bearing Designations			Mounting Dimensions			Mass
	Present		Original				
	tandem	back-to-back	face-to-face	tandem	back-to-back	face-to-face	
	mm						kg
7000C/DT	7000C/DB	7000C/DF	436100	236100	336100	12.4	0.036
7000AC/DT	7000AC/DB	7000AC/DF	446100	246100	346100	12.4	0.036
7200C/DT	7200C/DB	7200C/DF	436200	236200	336200	15	0.06
7200AC/DT	7200AC/DB	7200AC/DF	446200	246200	346200	15	0.06
7001C/DT	7001C/DB	7001C/DF	436101	236101	336101	14.4	0.04
7001AC/DT	7001AC/DB	7001AC/DF	446101	246101	346101	14.4	0.04
7201C/DT	7201C/DB	7201C/DF	436201	236201	336201	17	0.07
7201AC/DT	7201AC/DB	7201AC/DF	446201	246201	346201	17	0.07
7002C/DT	7002C/DB	7002C/DF	436102	236102	336102	17.4	0.056
7002AC/DT	7002AC/DB	7002AC/DF	446102	246102	346102	17.4	0.056
7202C/DT	7202C/DB	7202C/DF	436202	236202	336202	20	0.086
7202AC/DT	7202AC/DB	7202AC/DF	446202	246202	346202	20	0.086
7003C/DT	7003C/DB	7003C/DF	436103	236103	336103	19.4	0.072
7003AC/DT	7003AC/DB	7003AC/DF	446103	246103	346103	19.4	0.072
7203C/DT	7203C/DB	7203C/DF	436203	236203	336203	22	0.127
7203AC/DT	7203AC/DB	7203AC/DF	446203	246203	346203	22	0.127
7004C/DT	7004C/DB	7004C/DF	436104	236104	336104	25	0.128
7004AC/DT	7004AC/DB	7004AC/DF	446104	246104	346104	25	0.128
7204C/DT	7204C/DB	7204C/DF	436204	236204	336204	26	0.2
7204AC/DT	7204AC/DB	7204AC/DF	446204	246204	346204	26	0.2
7204B/DT	7204B/DB	7204B/DF	446204	246204	346204	26	0.22
	760204 TN1/P4 DFB					26	0.246
	760204 TN1/P4 DDB					26	0.246
7005C/DT	7005C/DB	7005C/DF	436105	236105	336105	30	0.148
7005AC/DT	7005AC/DB	7005AC/DF	446105	246105	346105	30	0.148
7205C/DT	7205C/DB	7205C/DF	436205	236205	336205	31	0.244
7205AC/DT	7205AC/DB	7205AC/DF	446205	246205	346205	31	0.244
7205B/DT	7205B/DB	7205B/DF	466205	266205	366205	31	0.26
7305C/DT	7305C/DB	7305C/DF	436305	236305	336305	32	0.46
7305AC/DT	7305AC/DB	7305AC/DF	446305	246305	346305	32	0.46
7305B/DT	7305B/DB	7305B/DF	466305	266305	366305	32	0.5
7006C/DT	7006C/DB	7006C/DF	436106	236106	336106	38	0.675
7006AC/DT	7006AC/DB	7006AC/DF	446106	246106	346106	36	0.22
7206C/DT	7206C/DB	7206C/DF	436206	236206	336206	36	0.22
7206AC/DT	7206AC/DB	7206AC/DF	446206	246206	346206	36	0.22



single row, in pairs

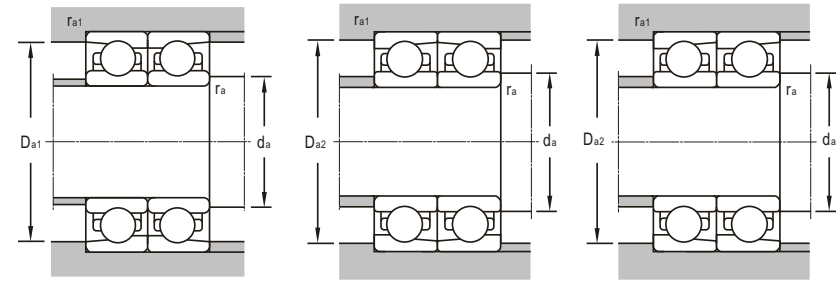
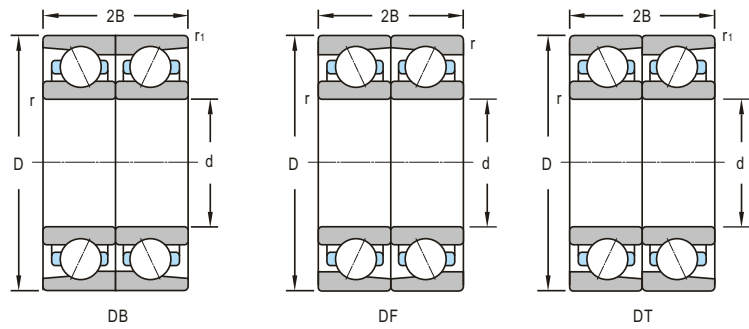

d 30~50mm

d	Boundary Dimensions				Basic Load Ratings		Limiting Speeds	
	D	2B	r _{min}	r _{1min}	Dynamic C	Static C ₀	Grease	Oil
mm								
					kN		r/min	
30	62	32	1	0.3	37.4	29.4	6300	9500
	62	32	1	0.3	35.9	28.2	6300	9000
	62	32	1	0.3	33.6	25	6300	9000
	72	38	1.1	0.6	58.3	44.6	6000	8500
	72	38	1.1	0.6	56.2	42.8	6000	8500
35	62	28	1	0.3	26.5	24.2	6000	8500
	62	28	1	0.3	25.2	23	6000	8500
	72	34	1.1	0.6	52.1	43.4	5600	7500
	72	34	1.1	0.6	49.9	41.4	5600	7500
	72	34	1.1	0.6	44	38	5600	7500
40	100	50	1.5	1.1	86	69	3200	4800
	68	30	1	0.3	32.7	30.4	5600	7500
	68	30	1	0.3	30.9	28.8	5600	7500
	80	36	1.1	0.6	59.9	51.2	5300	7000
	80	36	1.1	0.6	57.2	48.8	5300	7000
	80	36	1.1	0.6	53	46.8	5300	7000
	90	46	1.5	0.6	87.4	70	4500	6300
	90	46	1.5	0.6	84.1	67.6	4500	6300
	90	46	1.5	0.6	75.4	60.6	4500	6300
	100	50	1.5	0.6	96.9	79.4	4000	5600
45	58	14	1	0.3	9.54	11.4	6000	7500
	75	32	1	0.3	42.1	40.8	5300	7000
	75	32	1	0.3	39.8	38.6	5300	7000
	75	32	1	0.3	42.1	40.8	5000	7000
	85	38	1.1	0.6	62.7	56.6	4500	6300
	85	38	1.1	0.6	59.9	54.2	4500	6300
	85	38	1.1	0.6	58.5	52.6	4500	6300
	100	50	1.5	0.6	109	91.6	4000	5600
	100	50	1.5	0.6	108	88	4000	5600
	100	50	1.5	0.6	97	79.4	4000	5600
50	80	32	1	0.3	43.2	43.8	4500	6300
	80	32	1	0.3	40.9	42.8	4500	6300
	80	32	1	0.3	43.2	43.8	4500	6500
	90	40	1.1	0.6	69.5	63.4	4300	6000
	90	40	1.1	0.6	66.3	60.6	4300	6000
	90	40	1.1	0.6	46.7	45.6	4300	6000

Bearing Designations						Mounting Dimensions					Mass
Present			Original			d _a	D _{a1}	D _{a2}	r _a	r _{a1}	
tandem	back-to-back	face-to-face	tandem	back-to-back	face-to-face						
mm											
kg											
7206AC/DT			736206			36	56	59.6	1	0.3	0.234
7206B/DT	7206AC/DB	7206AC/DF	446206	246206	3462006	36	56	59.6	1	0.3	0.396
76026 TN/P4/T8TB	7206B/DB	7206B/DF	466206	266206	336206	36	56	59.6	1	0.3	0.42
7306C/DT	7306C/DB	7306C/DF	436306	236306	336306	37	65	67	1	0.6	0.7
7306AC/DT	7306AC/DB	7306AC/DF	446306	246306	346306	37	65	67	1	0.6	0.7
7306B/DT	7306B/DB	7306B/DF	466306	266306	366306	37	65	67	1	0.6	0.74
7007C/DT	7007C/DB	7007C/DF	436107	236107	336107	41	56	59.6	1	0.3	0.3
7007AC/DT	7007AC/DB	7007AC/DF	446107	246107	346107	41	56	59.6	1	0.3	0.3
7207C/DT	7207C/DB	7207C/DF	436207	236207	336207	42	65	67	1	0.6	0.61
7207AC/DT	7207AC/DB	7207AC/DF	446207	246207	346207	42	65	67	1	0.6	0.61
7207B/DT	7207B/DB	7207B/DF	466207	266207	366207	42	65	67	1	0.6	0.6
7407AC/DB						44	91	93	1.5	1	1.87
7008C/DT	7008C/DB	7008C/DF	436108	236108	336108	46	62	65.6	1	0.3	0.36
7008AC/DT	7008AC/DB	7008AC/DF	446108	246108	346108	46	62	65.6	1	0.3	0.36
7208C/DT	7208C/DB	7208C/DF	436208	236208	336208	47	73	75	1	0.6	0.737
7208AC/DT	7208AC/DB	7208AC/DF	446208	246208	346208	47	73	75	1	0.6	0.74
7208B/DT	7208B/DB	7208B/DF	466208	266208	366208	47	73	75	1	0.6	0.78
7308C/DT	7308C/DB	7308C/DF	436308	236308	336308	49	81	85	1.5	0.6	1.69
7308AC/DT	7308AC/DB	7308AC/DF	446308	246308	346308	49	81	85	1.5	0.6	1.32
7308B/DT	7308B/DB	7308B/DF	466308	266308	366308	49	81	85	1.5	0.6	1.34
7309B/DFYA2						49	91	95	1.5	0.6	2.07
71809CM/P4DT						48	55.6	52	0.25	0.1	0.097
7009C/DT	7009C/DB	7009C/DF	436109	236109	336109	51	69	72.6	1	0.3	0.46
7009AC/DT	7009AC/DB	7009AC/DF	446109	246109	346109	51	69	72.6	1	0.3	0.46
B7009C/DT			736109			51	69	72.6	1	0.3	0.484
7209C/DT	7209C/DB	7209C/DF	436209	236209	336209	52	78	80	1	0.6	0.814
7209AC/DT	7209AC/DB	7209AC/DF	446209	246209	346209	52	78	80	1	0.6	0.82
7209B/DT	7209B/DB	7209B/DF	466209	266209	366209	52	78	80	1	0.6	0.88
7309C/DT	7309C/DB	7309C/DF	436309	236309	336309	54	91	95	1.5	0.6	1.72
7309AC/DT	7309AC/DB	7309AC/DF	446309	246309	346309	54	91	95	1.5	0.6	1.72
7309B/DT	7309B/DB	7309B/DF	466309	266309	366309	54	91	95	1.5	0.6	1.8
7010C/DT	7010C/DB	7010C/DF	436110	236110	336110	56	74	77.6	1	0.3	0.5
7010AC/DT	7010AC/DB	7010AC/DF	446110	246110	346110	56	74	77.6	1	0.3	0.5
B7010C/DT			736110			56	74	77.6	1	0.3	0.52
7210C/DT	7210C/DB	7210C/DF	436210	236210	336210	57	83	85	1	0.6	0.92
						57	83	85	1	0.6	0.964
						57	83	85	1	0.6	0.997



single row, in pairs

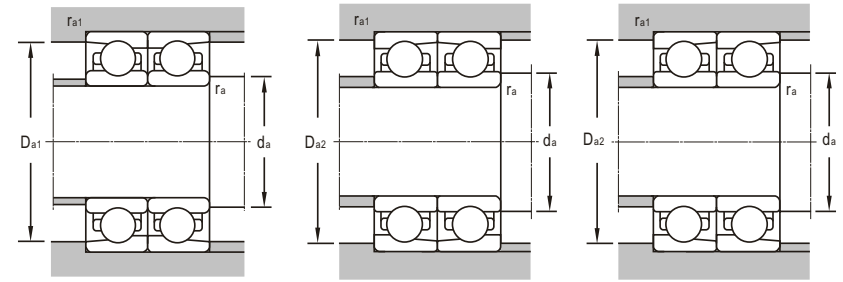
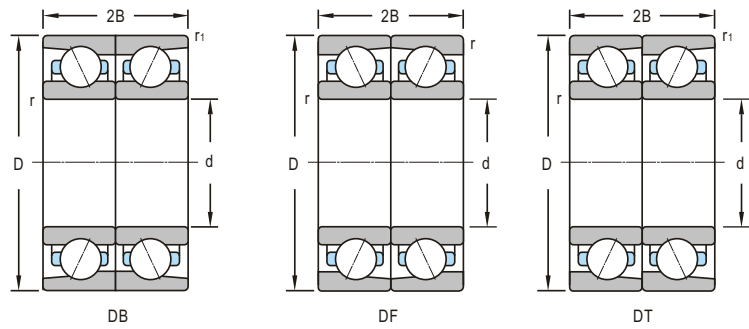

d 50~70mm

Boundary Dimensions					Basic Load Ratings		Limiting Speeds	
<i>d</i>	<i>D</i>	<i>2B</i>	<i>r</i> _{min}	<i>r</i> _{1min}	Dynamic <i>C</i>	Static <i>C</i> ₀	Grease	Oil
mm					kN		r/min	
50	90	40	1.1	0.6	66.3	60.6	4300	6000
	90	40	1.1	0.6	60.8	57.2	4300	6000
	90	40	1.1	0.6	69.5	63.4	4300	6000
	110	54	2	1	129	112	3800	5300
	110	54	2	1	124	108	3800	5300
55	90	36	1.1	0.6	60.4	57.2	4000	5600
	90	36	1.1	0.6	57.2	54.4	4000	5600
	90	36	1.1	0.6	57.2	54.4	4000	5600
	100	42	1.5	0.6	86.1	80.8	3800	5300
	100	42	1.5	0.6	82	76.4	3800	5300
	100	42	1.5	0.6	75.2	72.2	3800	5300
	120	58	2	1	149	131	3400	4800
60	120	58	2	1	143	126	3400	4800
	120	58	2	1	128	113	3400	4800
	95	36	1.1	0.6	62.1	65.2	3800	5300
	95	36	1.1	0.6	58.8	63.2	3800	5300
	110	44	1.5	0.6	91.1	96.6	3600	5000
65	110	44	1.5	0.6	94.5	92	3600	5000
	110	44	1.5	0.6	99.1	88.8	3600	5000
	130	62	2.1	1.1	171	153	3400	4500
	130	62	2.1	1.1	164	147	3400	4500
	130	62	2.1	1.1	146	131	3400	4500
70	100	36	1.1	0.6	65.1	70.8	3600	5000
	100	36	1.1	0.6	61.7	68.2	3600	5000
	120	46	1.5	0.6	114	110	3400	4500
	120	46	1.5	0.6	108	117	3400	4500
	120	46	1.5	0.6	108	117	3400	4500
	120	46	1.5	0.6	76.2	78.6	3400	4500
	120	46	1.5	0.6	103	92	3400	4500
	140	58.7	2.1	2.1	145	115	3200	4300
	140	66	2.1	1.1	197	178	3000	4000
	140	66	2.1	1.1	188	171	3000	4000
70	140	66	2.1	1.1	167	153	3000	4000
	110	40	1.1	0.6	78.5	86	3400	4800
	110	40	1.1	0.6	74.2	85	3400	4800
110	40	1.1	1	74.2	85.4	3500	5500	

Bearing Designations						Mounting Dimensions					Mass
Present			Original			<i>d</i> _a	<i>D</i> _{a1}	<i>D</i> _{a2}	<i>r</i> _a	<i>r</i> _{a1}	
tandem	back-to-back	face-to-face	tandem	back-to-back	face-to-face	mm					kg
7210AC/DT	7210AC/DB	7210AC/DF	446210	246210	346210	57	83	85	1	0.6	0.92
7210B/DT	7210B/DB	7210B/DF	466210	266210	366210	57	83	85	1	0.6	0.98
	7210C/DB/YA			3-642		57	83	85	1	0.6	1.95
7310C/DT	7310C/DB	7310C/DF	436310	236310	336310	60	100	104	2	1	2.16
7310AC/DT	7310AC/DB	7310AC/DF	446310	246310	346310	60	100	104	2	1	2.64
7310B/DT	7310B/DB	7310B/DF	466310	266310	366310	60	100	104	2	1	2.3
7011C/DT	7011C/DB	7011C/DF	436111	236111	336111	62	83	85	1	0.6	0.76
7011AC/DT	7011AC/DB	7011AC/DF	446111	246111	346111	62	83	85	1	0.6	0.76
	7011AC/N2L1/DB			246111K		62	83	85	1	0.6	0.788
7211C/DT	7211C/DB	7211C/DF	436211	236211	336211	64	91	95	1.5	0.6	1.22
7211AC/DT	7211AC/DB	7211AC/DF	446211	246211	346211	64	91	95	1.5	0.6	1.22
7211B/DT	7211B/DB	7211B/DF	466211	266211	366211	64	91	95	1.5	0.6	1.3
7311C/DT	7311C/DB	7311C/DF	436311	236311	336311	65	110	114	2	1	3.42
7311AC/DT	7311AC/DB	7311AC/DF	446311	246311	346311	65	110	114	2	1	2.84
7311B/DT	7311B/DB	7311B/DF	466311	266311	366311	65	110	114	2	1	2.9
7012C/DT	7012C/DB	7012C/DF	436112	236112	336112	67	88	90	1	0.6	0.8
7012AC/DT	7012AC/DB	7012AC/DF	446112	246112	346112	67	88	90	1	0.6	0.8
7212C/DT	7212C/DB	7212C/DF	436212	236212	336212	69	101	105	1.5	0.6	1.6
7212AC/DT	7212AC/DB	7212AC/DF	446212	246212	346212	69	101	105	1.5	0.6	1.6
7212B/DT	7212B/DB	7212B/DF	466212	266212	366212	69	101	105	1.5	0.6	1.68
7312C/DT	7312C/DB	7312C/DF	436312	236312	336312	72	118	123	2.1	1	3.4
7312AC/DT	7312AC/DB	7312AC/DF	446312	246312	346312	72	118	123	2.1	1	4.12
7312B/DT	7312B/DB	7312B/DF	466312	266312	366312	72	118	123	2.1	1	3.7
7013C/DT	7013C/DB	7013C/DF	436113	236113	336113	72	93	95	1	0.6	0.86
7013AC/DT	7013AC/DB	7013AC/DF	446113	246113	346113	72	93	95	1	0.6	0.86
7213C/DT	7213C/DB	7213C/DF	436213	236213	336213	74	111	115	1.5	0.6	2
7213AC/DT	7213AC/DB	7213AC/DF	446213	246213	346213	74	111	115	1.5	0.6	2
	7213AC/N2/DB			246213K		74	111	115	1.5	0.6	2.03
	7213EBN2/DB			D266213EK		74	111	115	1.5	0.6	2.17
7213B/DT	7213B/DB	7213B/DF	466213	266213	366213	74	111	115	1.5	0.6	2.1
3313 YA/P6						77	128	133	2.1	2.1	3.8
7313C/DT	7313C/DB	7313C/DF	436313	236313	336313	77	128	133	2.1	1	4.46
7313AC/DT		7313AC/DF	446313	246313	346313	77	128	133	2.1	1	4.46
7313B/DT		7313B/DF	466313	266313	366313	77	128	133	2.1	1	4.5
7014C/DT	7014C/DB	7014C/DF	436114	226114	336114	77	103	105	1	0.6	1.2
7014AC/DT	7014AC/DB	7014AC/DF	446114	246114	346114	77	103	105	1	0.6	1.2
B7014AC/DT			746114			77	103	104	1	1	1.18



single row, in pairs

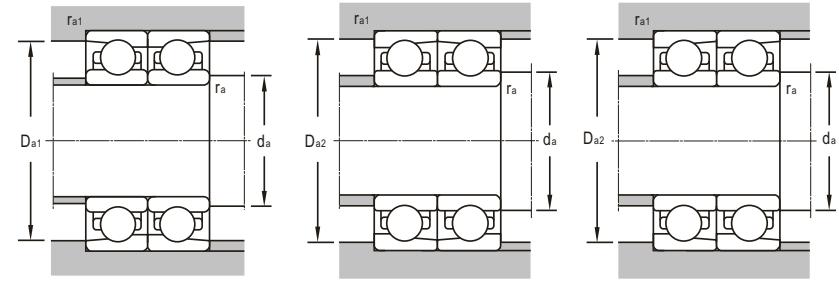
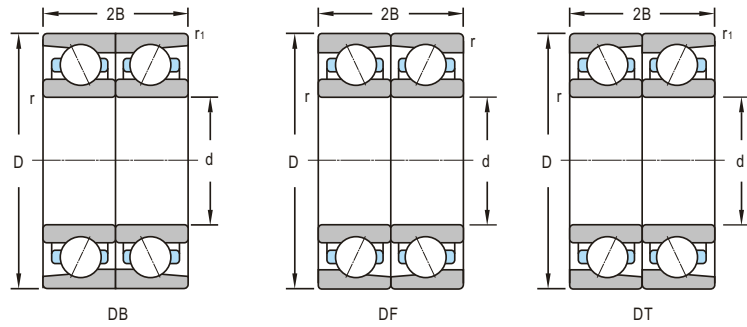

d 70~90mm

d	Boundary Dimensions				Basic Load Ratings		Limiting Speeds	
	D	2B	r _{min}	r _{1min}	Dynamic C	Static C ₀	Grease	Oil
mm				kN		r/min		
70	125	48	1.5	0.6	118	120	3200	4300
	125	48	1.5	0.6	123	123	3200	4300
	125	48	1.5	0.6	100	102	3200	4300
	150	70	2.1	1.1	218	200	2800	3600
	150	70	2.1	1.1	210	193	2800	3600
75	115	40	1.1	0.6	80.5	96	3400	4500
	115	40	1.1	0.6	76	91	3400	4500
	115	40	1.1	0.6	80.5	92.1	3400	4500
	130	50	1.5	0.6	129	131	3000	4000
	130	50	1.5	0.6	122	126	3000	4000
80	125	44	1.1	0.6	94.4	114	3200	4300
	125	44	1.1	0.6	90	110	3200	4300
	125	44	1.1	0.6	90	110	3200	4300
	140	52	2	1	145	154	2800	3600
	140	52	2	1	138	158	2800	3600
85	130	44	1.1	0.6	102	123	3000	4000
	130	44	1.1	0.6	96.2	118	3000	4000
	150	56	2	1	162	170	2600	3400
	150	56	2	1	154	162	2600	3400
	150	56	2	1	151	162	2600	3400
90	140	48	1.5	0.6	116	143	2800	3600
	140	48	1.5	0.6	110	137	2800	3600
	160	60	2	1	200	210	2400	3400

Bearing Designations						Mounting Dimensions					Mass
Present			Original			d _a	D _{a1}	D _{a2}	r _a	r _{a1}	kg
tandem	back-to-back	face-to-face	tandem	back-to-back	face-to-face	mm					
7214C/DT	7214C/DB	7214C/DF	436214	236214	336214	79	114	120	1.5	0.6	2.2
7214AC/DT	7214AC/DB	7214AC/DF	446214	246214	346214	79	114	120	1.5	0.6	2.2
7214B/DT	7214B/DB	7214B/DF	466214	266214	366214	79	114	120	1.5	0.6	2.3
7314C/DT	7314C/DB	7314C/DF	436314	236314	336314	79	141	143	1.5	1	5.34
7314AC/DT	7314AC/DB	7314AC/DF	446314	246314	346314	79	141	143	1.5	1	6.12
7314B/DT	7314B/DB	7314B/DF	466314	266314	366314	79	141	143	1.5	1	5.5
7015C/DT	7015C/DB	7015C/DF	436115	236115	336115	82	108	110	1	0.6	1.26
7015EA/DT	7015EA/DB	7015EA/DF	446115E	246115E	346115E	82	108	110	1	0.6	1.26
7215C/DT	7215C/DB	7215C/DF	436215	236215	336215	84	121	125	1.5	0.6	2.4
7215AC/DT	7215AC/DB	7215AC/DF	446215	246215	346215	84	121	125	1.5	0.6	2.4
7215B/DT	7215B/DB	7215B/DF	466215	266215	366215	84	121	125	1.5	0.6	2.6
7315C/DT	7315C/DB	7315C/DF	436315	236315	336315	87	148	153	2.1	1	7.12
7315AC/DT	7315AC/DB	7315AC/DF	446315	246315	346315	87	148	153	2.1	1	7.12
7315B/DT	7315B/DB	7315B/DF	466315	266315	366315	87	148	153	2.1	1	6.6
7016C/DT	7016C/DB	7016C/DF	436116	236116	336116	87	118	120	1	0.6	1.7
7016AC/DT	7016AC/DB	7016AC/DF	446116	246116	346116	87	118	120	1	0.6	1.7
7216C/DT	7216C/DB	7216C/DF	436216	236216	336216	90	130	134	2	1	2.9
7216AC/DT	7216AC/DB	7216AC/DF	446216	246216	346216	90	130	134	2	1	2.9
7216B/DT	7216B/DB	7216B/DF	466216	266216	366216	90	130	134	2	1	2.99
7316C/DT	7316C/DB	7316C/DF	436316	236316	336316	92	158	163	2.1	1	7.18
7316AC/DT	7316AC/DB	7316AC/DF	446316	246316	346316	92	158	163	2.1	1	7.18
7316B/DT	7316B/DB	7316B/DF	466316	266316	366316	92	158	163	2.1	1	7.8
7017C/DT	7017C/DB	7017C/DF	436117	236117	336117	92	123	126	1	0.6	1.78
7017AC/DT	7017AC/DB	7017AC/DF	446117	246117	346117	92	123	126	1	0.6	1.78
7217C/DT	7217C/DB	7217C/DF	436217	236217	336217	95	140	144	2	1	3.6
7217AC/DT	7217AC/DB	7217AC/DF	446217	246217	346217	95	140	144	2	1	3.6
7217B/DT	7217B/DB	7217B/DF	466217	266217	366217	95	140	144	2	1	3.9
7317C/DT	7317C/DB	7317C/DF	436317	236317	336317	99	166	173	2.5	1	8.76
7317AC/DT	7317AC/DB	7317AC/DF	446317	246317	346317	99	166	173	2.5	1	8.76
7317B/DT	7317B/DB	7317B/DF	466317	266317	366317	99	166	173	2.5	1	9.2
7018C/DT	7018C/DB	7018C/DF	436118	236118	336118	99	131	135	1.5	0.6	2.3
7018AC/DT	7018AC/DB	7018AC/DF	446118	246118	346118	99	131	135	1.5	0.6	1.62
7218C/DT	7218C/DB	7218C/DF	436218E	236218E	336218E	100	150	154	2	1	4.5



single row, in pairs

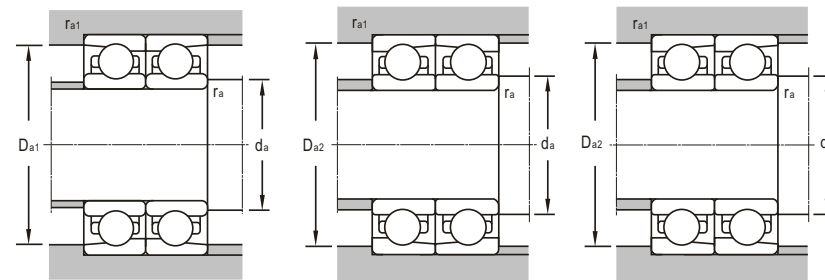
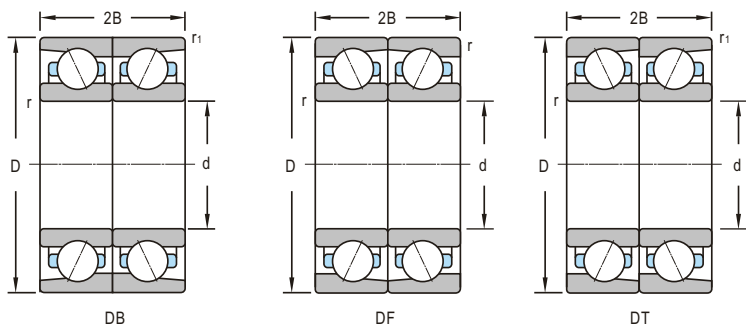

d 90~110mm

d	Boundary Dimensions				Basic Load Ratings		Limiting Speeds	
	D	2B	r _{min}	r _{1min}	Dynamic C	Static C ₀	Grease	Oil
mm								
					kN		r/min	
90	160	60	2	1	190	200	2400	3400
	160	60	2	1	172	188	2400	3400
	190	86	3	1.1	301	320	2200	3000
	190	86	3	1.1	289	308	2200	3000
	190	86	3	1.1	257	274	2200	3000
95	145	48	1.5	0.6	120	154	2600	3400
	145	48	1.5	0.6	113	142	2600	3400
	170	64	2.1	1.1	219	226	2400	3200
	170	64	2.1	1.1	208	229	2400	3200
	170	64	2.1	1.1	197	202	2400	3200
200	90	3	1.1	327	360	2000	2800	
	90	3	1.1	314	346	2000	2800	
95	200	90	3	1.1	279	308	2000	2800
100	150	48	1.5	0.6	129	163	2600	3400
	150	48	1.5	0.6	122	150	2600	3400
	180	68	2.1	1.1	242	254	2200	3000
	180	68	2.1	1.1	231	260	2200	3000
	180	68	2.1	1.1	211	228	2200	3000
	215	94	3	1.1	361	414	1800	2400
	215	94	3	1.1	348	398	1800	2400
	215	94	3	1.1	309	354	1800	2400
105	160	52	2	1	144	183	2600	3400
	160	52	2	1	136	174	2600	3400
	190	72	2.1	1.1	263	286	2000	2800
	190	72	2.1	1.1	252	274	2000	2800
	190	72	2.1	1.1	232	258	2000	2800
110	170	56	2	1	174	216	2400	3400
	170	56	2	1	169	208	2400	3400
	170	84	2	1	224	312	2200	3200
	170	84	2	1	224	312	2200	3200
	200	76	2.1	1.1	286	342	1900	2600
	200	76	2.1	1.1	273	306	1900	2600
	200	76	2.1	1.1	250	288	1900	2600
	240	100	3	1.1	411	504	1500	2200

Bearing Designations						Mounting Dimensions					Mass
Present			Original			d _a	D _{a1}	D _{a2}	r _a	r _{a1}	
tandem	back-to-back	face-to-face	tandem	back-to-back	face-to-face						
mm											
											kg
7218ACM/DF						100	150	154	2	1	5.32
7218B/DT	7218B/DB	7218B/DF	466218	266218	366218	100	150	154	2	1	4.8
7318C/DT	7318C/DB	7318C/DF	436318	236318	336318	104	176	183	2.5	1	9.76
7318AC/DT	7318AC/DB	7318AC/DF	446318	246318	346318	104	176	183	2.5	1	10.12
7318B/DT	7318B/DB	7318B/DF	466318	266318	366318	104	176	183	2.5	1	10.8
7318EBN2DB						104	176	183	2.5	1	11.3
266318EK											
7019C/DT	7019C/DB	7019C/DF	436119	236119	336119	104	136	140	1.5	0.6	2.4
7019AC/DT	7019AC/DB	7019AC/DF	446119	246119	346119	104	136	140	1.5	0.6	2.4
7219C/DT	7219C/DB	7219C/DF	436219	236219	336219	107	158	163	2.1	1	5.4
7219AC/DT	7219AC/DB	7219AC/DF	446219	246219	346219	107	158	163	2.1	1	5.4
7219B/DT	7219B/DB	7219B/DF	466219	266219	366219	107	158	163	2.1	1	5.8
7319C/DT	7319C/DB	7319C/DF	436319	236319	336319	109	186	193	2.5	1	12
7319AC/DT	7319AC/DB	7319AC/DF	446319	246319	346319	109	186	193	2.5	1	12
7319B/DT	7319B/DB	7319B/DF	466319	266319	366319	109	186	193	2.5	1	12.5
7020C/DT	7020C/DB	7020C/DF	436120	236120	336120	109	141	145	1.5	0.6	2.5
7020AC/DT	7020AC/DB	7020AC/DF	446120	246120	346120	109	141	145	1.5	0.6	2.5
7220C/DT	7220C/DB	7220C/DF	436220	236220	336220	112	168	173	2.1	1	6.5
7220AC/DT	7220AC/DB	7220AC/DF	446220	246220	346220	112	168	173	2.1	1	6.5
7220B/DT	7220B/DB	7220B/DF	466220	266220	366220	112	168	173	2.1	1	6.9
7320C/DT	7320C/DB	7320C/DF	436320	236320	336320	114	201	208	2.5	1	14.4
7320AC/DT	7320AC/DB	7320AC/DF	446320	246320	346320	114	201	208	2.5	1	16.9
7320B/DT	7320B/DB	7320B/DF	466320	266320	366320	114	201	208	2.5	1	15.5
7020AC/TBT						109	141	145	1.5	0.6	
7021C/DT	7021C/DB	7021C/DF	436121	236121	336121	115	150	154	2	1	3.2
7021AC/DT	7021AC/DB	7021AC/DF	446121	246121	346121	115	150	154	2	1	3.2
7221C/DT	7221C/DB	7221C/DF	436221	236221	336221	117	178	173	2.1	1	7.7
7221AC/DT	7221AC/DB	7221AC/DF	446221	246221	346221	117	178	173	2.1	1	7.7
7221B/DT	7221B/DB	7221B/DF	466221	266221	366221	117	178	173	2.1	1	8.2
7022C/DT	7022C/DB	7022C/DF	436122	236122	336122	120	160	164	2	1	4.92
7022AC/DT	7022AC/DB	7022AC/DF	446122	246122	346122	120	160	164	2	1	4.92
7022AC/TBT						120	160	164	2	1	7.38
946122Y						120	160	164	2	1	7.38
B7022AC/TBT						120	160	164	2	1	7.38
7222C/DT	7222C/DB	7222C/DF	436222	236222	336222	122	188	193	2.1	1	9.1
7222AC/DT	7222AC/DB	7222AC/DF	446222	246222	346222	122	188	193	2.1	1	9.1
7222B/DT	7222B/DB	7222B/DF	466222	266222	366222	122	188	193	2.1	1	9.6
7322AC/DT	7322AC/DB	7322AC/DF	446322	246322	346322	124	226	233	2.5	1	19.6

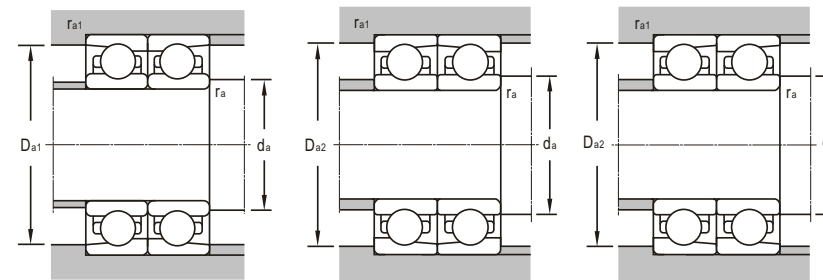
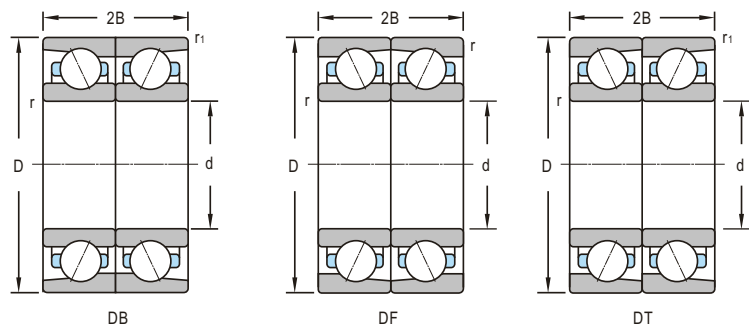

d 110~460mm

d	Boundary Dimensions				Basic Load Ratings		Limiting Speeds	
	D	2B	r _{min}	r _{1min}	Dynamic C	Static C ₀	Grease	Oil
mm								
					kN		r/min	
110	240	100	3	1.1	367	450	1500	2200
	240	100	3	1.1	411	504	1100	2200
120	215	80	2.1	1.1	309	358	1700	2400
	215	80	2.1	1.1	294	367	1700	2400
	215	80	2.1	1.1	268	322	1700	2400
	215	160	4	2.5	435.5	644	1700	2400
130	200	63	2	1	117	167	1100	2200
	230	80	3	1.1	292	364	1500	2200
140	250	84	2.1	1.1	281	389	1800	2300
150	230	70	2.1	2.1	229	322	1810	2200
160	290	96	3	1.1	416	590	800	1800
	340	136	4	1.5	601	892	700	1600
180	280	100	2.1	1.1	280	420	1500	1900
190	260	66	4	2.5	226	354	1500	1900
203.23	276.25	73	2	1	237	362	1300	1500
220	400	130	4	1.5	582	1014	750	1100
240	360	118	3	3	404	712	900	1250
260	369.5	118	3	3	362	643	1000	1300
	400	140	4	1.5	489	900	750	980
280	389.5	92	2.1	2.1	397	732	750	110
300	419.5	112	4	1.5	442	847	660	950
340	400	115	2.1	1.1	157	344	640	960
420	560	130	3	1.5	733	1304	540	680
460	580	56	3	3	596	1396	670	830

Bearing Designations						Mounting Dimensions					Mass
Present			Original			d _a	D _{a1}	D _{a2}	r _a	r _{a1}	kg
tandem	back-to-back	face-to-face	tandem	back-to-back	face-to-face						
mm											
7322B/DT	7322B/DB	7322B/DF	466322	266322	366322	124	226	233	2.5	1	20.6
	B7322AC/DB			546322		124	226	233	2.5	1	23.5
7224C/DT	7224C/DB	7224C/DF	436224	236224	336224	132	203	208	2.1	1	10.8
7224AC/DT	7224AC/DB	7224AC/DF	446224	246224	346224	132	203	208	2.1	1	10.8
7224B/DT	7224B/DB	7224B/DF	466224	266224	366224	132	203	208	2.1	1	12.3
7224B/QT			3-634			132	203	208	2.1	1	24.5
	7026TN/DBYA			246126KA		140	190	194	2	1	6.76
7226AC/DB						146	212	214	2.5	1	14.9
7228C/DT	7228C/DB	7228C/DF	436228	236228	336228	152	238	243	2.1	1	19.8
4030X2DCM/P5						162		218	2.1	2.1	10.4
7232ACM/P4DB	B7332AC/DB		546332			174	283	283	2.5	1.1	29.2
						178	322	331	3	1.5	65.3
4036D			4286136			192	268	273	2.1	1	20.9
		71938AC/DF			1346938	208	242	246	3	2.1	8.9
49/203.23D						213	266	270	2	1	13.5
7244AC/DT	7244AC/DB	7244AC/DF	446244	246244	346244	238	382	391	3	1.5	77
4048D						254	346	346	2.5	2.5	39.3
4052X3D						274	355	355	2.5	2.5	39.7
4052D/C2						290	383	374	3	1.5	60.5
4956X3D						292	377	377	2.1	2.1	34.7
4960X3D/C2						327	404	397	2.5	1	45.8
4868X3D/YB2						352	388	393	2.1	1	21.6
		71984DF		1346984K		434	546	551	2.5	1.5	105
71892 AM/DT						476	560	564	2.5	2.5	68

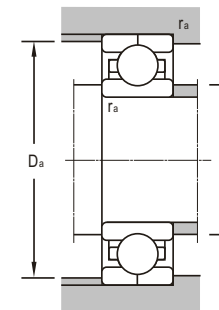
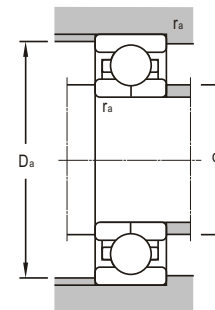
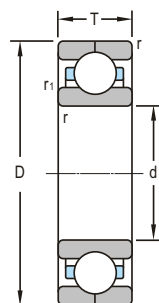
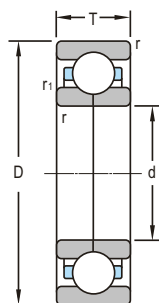

d 10~100mm

Boundary Dimensions						Basic Load Ratings		Limiting Speeds	
<i>d</i>	<i>D</i>	<i>B</i>	<i>T</i>	<i>r_{min}</i>	<i>r₁</i>	Dynamic <i>C</i>	Static <i>C₀</i>	Grease	Oil
mm						kN		r/min	
10	28	8	8	0.3	0.3	5.82	2.53	24000	30000
16	30	106.2	106.2	1.4	1.4	11.3	6.5	7.9	5.4
17	35	10	10	0.3	0.3	8.23	4.53	15000	20000
20	47	12	12	1.1	0.5	15.5	8.92	15000	19000
25	62	17	20	1.1	0.6	27	15.6	11000	14500
	67	20.6	34	1	0.8	23.5	19.3	11000	14500
26	62	17	20	1.1	0.5	27	15.6	11000	14500
32	72	24.5	30	1.1	0.5	32.8	20.5	18000	12000
30	72	19	19	1.1		38.5	38	6700	9000
35	59.482	14.5	14.5	1.1	0.5	21.4	14.9	8000	10000
	80	29	33.5	1.5	0.5	40.2	24.7	9000	11000
53	84	16.15	20	1.1	0.6	17.4	14.7	7300	9200
63	102	23	27	2	1	31.5	21.6	6000	8000
65	102	16.5	21.5	1.1	1.1	26.9	21.7	6000	8000
	140	33	33	2.1	2.1	118	132	3800	5300
70	125	24	24	1.5		51.8	43.1	3200	4300
75	160	37	37	2.1	2.1	163	204	3400	4800
80	140	21	26.5	2	1	51	48	3500	4400
81	107	17	17	0.5	0.5	16.4	24.6		
90	140	24	24	1.5		59.1	56.6	6000	7600
	190	43	43	3		193	259	2400	3400
91	117	20	20	0.5	0.5	17	26.9		
100	180	34	34	2.1	2.1	152	215	2800	3800

Bearing Designations		Mounting Dimensions			Mass
Present	Original	<i>d_{1min}</i>	<i>D_{amax}</i>	<i>r_{amax}</i>	
		mm			kg
S7600	6700	12.4	25.6	0.3	0.0227
WR1630106.2	3-637				0.253
S71003	106103	19.4	32.6	0.3	0.0452
S70204X2	6704	27	40	1	0.103
SN7305X2/YA	26705	32	55	1	0.276
4605-2RS	186705	31	61	1	0.523
S76/26/YA	26905	33	55	1	0.281
SN76/32/YA	26706	39	65	1	0.454
QJS306	176306	37	65	1	0.418
LR7607	226707	42	53	1	0.105
SN72307X2/YA	26707	44	71	1.5	0.561
46/53/YA	996911K1	60	77	1	0.44
B76/63/YA	26913	73	92	2	0.707
QJ313	996713	72	95	1	0.569
	176313	77	128	2.1	2.7
QJS214	276214	79	114	1.5	1.31
QJ315N2	176315	87	148	2.1	4.04
S7216X2/YA	26216	90	130	2	1.33
LY-Q017		83.5	104.5	0.5	0.312
QJ1018	1176118	99	131	1.5	1.47
QJ318	176318	104	176	2.5	6.51
LY-Q018		93.5	114.5	0.5	0.346
QJ220N2		112	168	2.1	4.22

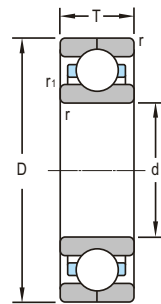
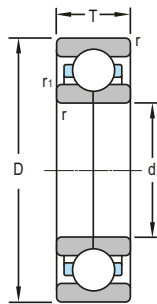

d 120~1060mm

Boundary Dimensions						Basic Load Ratings		Limiting Speeds	
<i>d</i>	<i>D</i>	<i>B</i>	<i>T</i>	<i>r_{min}</i>	<i>r₁</i>	Dynamic <i>C</i>	Static <i>C₀</i>	Grease	Oil
mm						kN		r/min	
120	165	34	34	1.1	0.8	85.4	131	1400	2000
	215	40	40	2.1	2.1	209	318	2400	3200
	260	55	55	3	3	263	365	1600	2200
140	210	33	33	2	2	206	273	3200	4000
	250	42	42	3	3	252	436	2000	2800
	300	62	62	4	4	361	646	1700	2400
150	225	35	35	2.1	2.1	169	298	3000	3700
160	220	45	45	2	1	125	208	1000	1500
	290	48	48	3	3	286	533	1700	2400
170	230	45	45	2	1	128	220	950	1450
	260	42	42	2.1	2.1	221	409	1800	2400
	310	52	52	4	4	382	742	2000	1500
180	280	46	46	2.1	2.1	246	481	1300	1800
	280	46	46	2.1	2.1	246	481	1300	1800
190	260	33	33	2	2	125	177	2600	3200
220	300	60	60	2.5	1.2	219	392	1900	2400
	340	56	56	3	3	306	653	1200	1700
240	440	72	72	4	4	649	1200	1000	1500
260	368	48	48	2.1	2.1	298	676	1000	1400
280	420	65	65	4	4	410	1010	1400	1800
	389.5	65	65	4	4	433	803	900	1100
320	440	50	100	4	4	237	492	1200	1500
	480	74	74	4	4	447	587	800	1100
	580	92	92	5	5	946	2100		
360	540	82	82	5	5	491	900	1000	1300
1000	1380	190							
1060	1500	195							

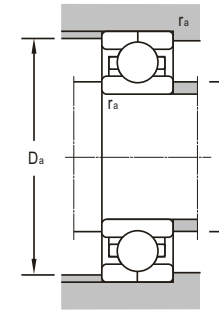
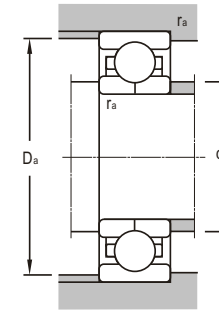

Bearing Designations		Mounting Dimensions			Mass
Present	Original	<i>d_{1min}</i>	<i>D_{max}</i>	<i>r_{amax}</i>	
		mm			kg
3924D	3356924	127	158	1	2.51
QJ224N2		132	203	2.1	7.04
QJF324	116324	134	246	2.5	15.6
QJF1028	176128	150	200	2	4.33
QJ228N2		154	236	2.5	10.1
QJ328		158	382	3	
QJF1030	176130	162	213	2.1	5.16
3932D	3356932	170	210	2	5.41
QJ232		174	276	2.5	16
3934D	3356934	180	220	2	5.9
QJF1034		182	248	2.1	8.18
QJ234N2	176234K	188	292	3	18.107
QJ1036	176136	192	268	2.1	11.4
QJ1036N2	176136K	192	268	2.1	11.4
QJ1938	1176938	200	250	2	6.02
3944D	3356944	234	286	2.1	13.1
QJ1044N2	176144	234	326	2.5	20.2
QJF248M		258	222	3	51.6
QJF1952X2		272	356	2.1	16.9
QJF1056	176156	298	402	3	34.3
QJF1056X1		298	371	3	23.2
7664D		338	422	3	
QJF1064	176164	338	462	3	50
QJF 264 M		342	558	4	123
QJF1072	176172	382	518	4	71.5
QJ 6/1000M				393	
QJ 6/1060MA/C9				393	

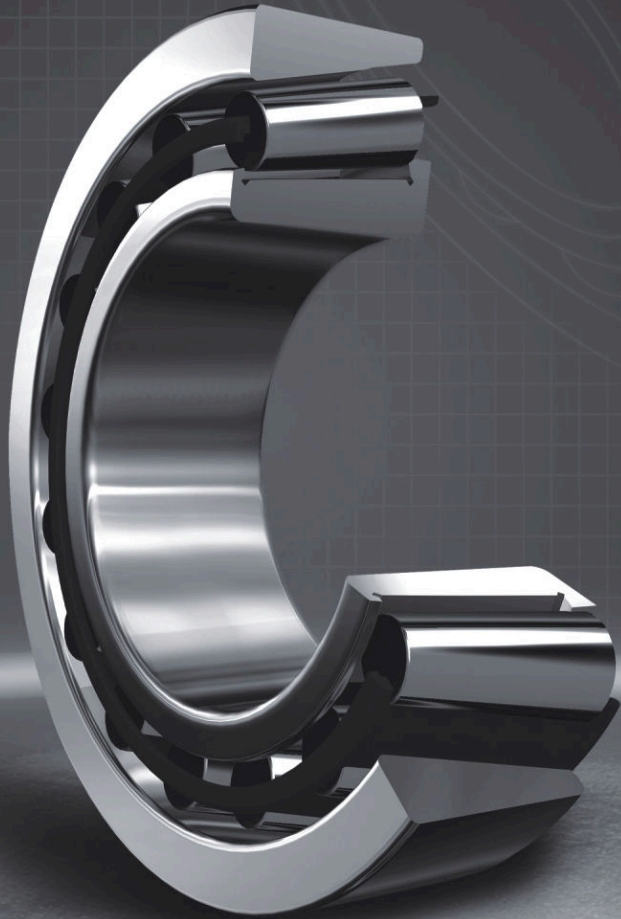

Taper Roller Bearings



303

Taper Roller Bearings

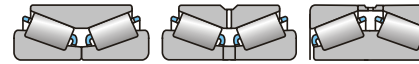

329

Double-Row Taper Roller Bearings

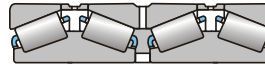

353

Four-Row Taper Roller Bearings



Taper Roller Bearings

LYC taper roller bearings have tapered cone and cup between which taper rollers are arranged. The extension lines of them intersect at one point of shaft axis; therefore, pure rolling on the raceway can be achieved.

Taper roller bearings are separable. Bearing cone (including roller, cage and inner ring) and cup (outer ring) can be separated, therefore, it can be easily assembled on the bearing journal and bearing block.

Taper roller bearings are able to accommodate radial loads, unidirectional axial loads and combined loads of radial and axial. The axial load carrying capacity of taper roller bearings is largely determined by the contact angle α , which corresponds to the raceway angle of the cup, the larger the contact angle α the higher the axial load carrying capacity is.

Generally, taper roller bearings do not allow any angle error, but the surface of roller and raceway can allow 2'~4' angle error after a special design. Taper roller bearings have single row, double-row, and four-row types. LYC manufactures both metric and inch size taper roller bearings.

Single Row Taper Roller Bearings

Single row taper roller bearing can bear a unidirectional axial load, and limit the unidirectional axial relative displacement between shaft and housing. Even under pure radial load, annex axial component of forces can be made in the internal part of taper roller bearings. Then, another equal counterforce is needed to counteract it. Usually, two single-row taper roller bearings with a same structure are assembled face to face or back to back. See Fig.1.

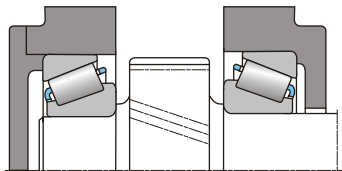

Fig. 1

Single Row Taper Roller Bearings Assembled in Pairs

Single-row taper roller bearings can be assembled in pairs. These are face-to-face and back-to-back arrangements. Please see Fig.2.

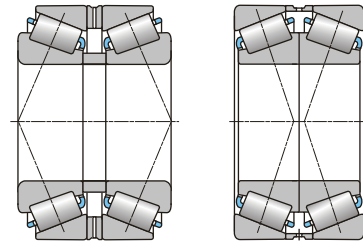

Fig. 2

Taper Roller Bearing with Snap Rib

The outer ring of taper roller bearing is with snap rib as in Fig.3. The internal parts of this type of bearings are arranged the same with the internal parts of single row taper roller bearing. Taper roller bearings with snap ribs can be located axially on the shaft block, which, can help to simplify the allocation design and the structure of shaft block.

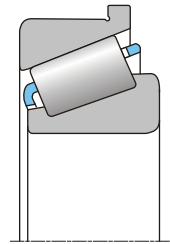

Fig. 3

Double-Row Taper Roller Bearings

Double-row taper roller bearings can carry radial loads and double-direction axial loads. The clearance of the double-row taper roller bearings have to be adjusted properly before delivery. They can be mounted and used directly without adjusting again. Double-row taper roller bearings can limit the displacement in both directions on the shaft to housing in the range of axial clearance. Double-row taper roller bearings can be arranged back to back and face to face. See Fig.4.

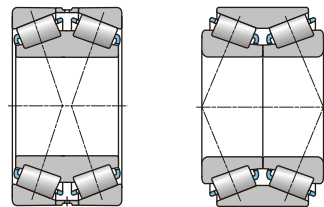

Fig. 4

Four-Row Taper Roller Bearings

The performance of four-row taper roller bearings is almost the same as the double-row taper roller bearings, and it can carry much more radial loads than the double-row taper roller bearings. However, the limiting speed of four-row taper roller bearing is comparably lower. These are mainly used by heavy engine machines, such as, in a rolling mill.

LYC can provide customers other taper roller bearings with special structures, such as sealed taper roller bearing, etc. All types cannot be listed in this catalogue. If customers require other types, then please consult LYC technical department.

Cage

Cages for taper roller bearings are supplied by LYC, these are pressed steel cages, machined solid cages, glass fiber reinforced polyamide 66 cages and etc. For taper roller bearings with larger sizes, then solid cages can be welded with steel stanchions.

Minimum Load

In order to ensure bearings work in good condition, a minimum load must be imposed on the bearings, particularly on bearings working at high speeds, high accelerations, or with the load direction changing frequently, because under these working conditions, inertial force of balls and cage and lubricant friction will have bad influence on the rotation of bearings, and detrimental sliding movement may be caused.

The minimum load of a taper roller bearing can be obtained from

$$F_{\min} = 0.02C$$

Where

C — Basic dynamic load rating, KN

When bearings are started at low ambient temperatures or in the condition that the viscosity of lubricant is very large, then a minimum load is required. Usually, the weight of bearing supporting parts plus the load on the bearing should be over the minimum load. If the weight cannot be up to the minimum load, then extra radial load must be imposed on this type of bearing in order to meet the requirements of minimum load. The requirement can be met through preloading with axial springs.

Dimension, Tolerance, Clearance

LYC's standard taper roller bearing boundary dimension is in accordance with GB/T273.3 <Rolling Bearing, Taper Roller Bearing, and Boundary Dimension General Specification>, GB/T297 <Rolling Bearing, Taper Roller Bearings, and Boundary Dimension>, GB/T299 <Rolling Bearing, and Boundary Dimensions of Double-Row Taper Roller Bearings>, GB/T300 <Rolling Bearing, and Boundary Dimensions of Four-Row Taper Roller Bearings>.

The tolerance of LYC's standard taper roller bearing is in accordance with GB/T307.1 <Rolling Bearing, Radial Bearing, and Tolerance>. The clearance of single row taper roller bearings only can be achieved after adjusting the axial position of outer ring, internal parts. Bearings have to be turned repeatedly in order to make the rollers and inner ring guide flange into a proper contacting position. The value of clearance can be decided by the customer according to different working conditions. However, please note that too big clearance would weaken the load carrying capacity, but, too little clearance would cause too much friction equal to very high operating temperature. While bearings having a lower operating temperature, smaller vibration and higher rotating precision, we can judge that the clearance value has been adjusted to the best condition. The clearance of double-row and four-row taper roller bearings are adjusted accurately before delivery. Customers can use them directly without adjusting again.

The dimensional tolerance of LYC's standard taper roller bearing is the normal grade P0. If customers have other special requirements on dimension, tolerance, and clearance, LYC have the ability to supply the corresponding products, including non-standard products.

Equivalent Dynamic Load

The equivalent dynamic load of taper roller bearings can be calculated as the following Table 1.



Table 1

Bearing Structure	Equivalent Dynamic Load
Single row taper roller bearing	$F_a/F_r \leq e$ $P = F_r$ $F_a/F_r > e$ $P = 0.4F_r + YF_a$ Annex axial component of forces $S = F_r / 2Y$
Single row taper roller bearing of paired mounting (Arranged face to face or back to back)	$F_a/F_r \leq e$ $P = F_r + Y_1 F_a$ $F_a/F_r > e$ $P = 0.67F_r + Y_2 F_a$
Double-row or four-row taper roller bearing	$F_a/F_r \leq e$ $P = F_r + Y_1 F_a$ $F_a/F_r > e$ $P = 0.67F_r + Y_2 F_a$

Equivalent Static Load

The equivalent static load of taper roller bearings can be calculated from

Table 2

Bearing Structure	Equivalent Dynamic Load
Single row taper roller bearing	normal $P_0 = 0.5F_r + Y_0 F_a$ $P_0 < F_r$ $P_0 = F_r$
Single row taper roller bearing of paired mounting (Arranged face to face or back to back)	normal $P_0 = F_r + Y_0 F_a$ $P_0 < F_r$ $P_0 = F_r$
Double-row or four-row taper roller bearing	normal $P_0 = F_r + Y_0 F_a$ $P_0 < F_r$ $P_0 = F_r$

Coefficients e, Y_1, Y_2, Y_0 are listed in the bearing dimension table.

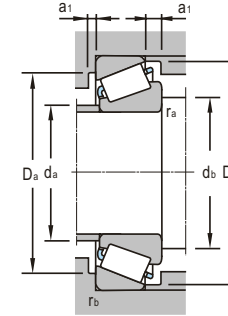
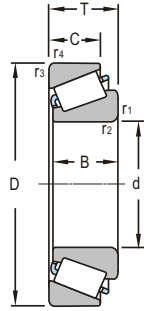

d 15~35mm

Boundary Dimensions							Basic Load Ratings		Limiting Speeds	
d	D	T	B	C	r _{1,2min}	r _{3,4min}	Dynamic C	Static C ₀	Grease	Oil
mm							kN		r/min	
15	30	13	12	11	1	0.3	14	15	9000	13000
	35	14.8	15	11.75	1	0.3	21.8	22.4	9000	13000
	42	14.25	13	11	1	1	22.9	21.7	9000	13000
17	40	13.25	12	11	1	1	20.7	22.2	9000	13000
	47	15.25	14	12	1	1	27.5	28.3	8500	12000
	47	20.25	19	16	1	1	35.4	36.6	8000	11000
20	47	15.25	14	12	1	1	28.2	30.9	8000	11000
	52	16.25	15	13	1.5	1.5	33.2	33.3	8000	11000
	52	22.25	21	18	1.5	1.5	42.7	46.4	7500	10000
22	47	20	21	16	1	1	39.5	46	7500	1000
25	52	16.25	15	13	1	1	33.7	39.4	7500	10000
	52	19.25	18	16	1	1	39	48.8	7000	9500
	62	18.25	17	13	1.5	1.5	40.7	46	5600	7500
	62	18.25	17	14	1.5	1.5	40.7	46	5600	7500
	62	18.25	17	15	1.5	1.5	47	48.3	6700	9000
	62	25.25	24	20	1.5	1.5	61.7	68.9	6000	8000
	62	25.25	24	20	1.5	1.5	49.1	48.1	5600	7500
30	58	19.45	20	15.5	1.5	0.3	45.9	57.2	6100	7700
	62	17.25	16	14	1	1	43.3	50.6	6300	8500
	62	21.25	20	17	1	1	51.8	63.9	6300	8500
	72	20.75	19	16	1.5	1.5	59	63.9	5600	7500
	72	20.75	19	14	1.5	1.5	45	46	5000	6700
	72	24.5	24	17.6	3	1.5	53.8	65.9	5600	7500
	72	28.75	27	23	1.5	1.5	66.8	83.3	5300	7000
	72	28.75	27	23	1.5	1.5	66.8	83.3	5300	7000
32	75	29.75	28	23	1.5	1.5	76.9	60.6	5200	6900
35	62	18	18	14	1	1	42.3	53.7	6000	8000
	65	18	18	14	3.5	3.5	41.3	59	6000	8000
	72	18.25	17	15	1.5	1.5	54.2	63.7	5300	7000
	72	24.25	23	19	1.5	1.5	70.6	89.7	5300	7000
	72	28	28	22	1.5	1.5	82.6	102	5500	7000
	80	22.75	21	18	2	1.5	75.4	83.6	5000	6700
	80	22.75	21	15	2	1.5	60	64	4500	6000
80	32.75	31	25	2	1.5	99.1	119.7	4800	6300	

Bearing Designations			Mounting Dimensions						Calculation Factors				Mass		
Present	Original	ISO355 Series code	d _{amax}	d _{bmax}	D _{amin}	D _{bmin}	a ₁	a ₂	r _{amax}	r _{bmax}	Y ₁	Y ₂	Y ₀	e	kg
			mm												
30602-1(TD-CRS200256)			17	17	25	28	3	7	1	0.3	2.1	1.1	0.29	0.0407	
30602(RV-70FC)			17	18	30	33	3	5	1	0.3	2.5	1.4	0.24	0.0716	
30302	7302E	2FB	23	23	35	36	3	5	1	1	2.1	1.1	0.28	0.0948	
30203	7203E	2DB	22	22	34	35	2	4	1	1	1.7	0.9	0.35	0.0781	
30303	7303E	2FB	25	25	41	42	3	5	1	1	2.1	1.1	0.28	0.13	
32303	7603E	2FD	25	25	41	42	3	6	1	1	2.1	1.1	0.28	0.174	
30204	7204E	2DB	26	26	42	43	3	5	1	1	1.7	0.9	0.35	0.127	
30304	7304E	2FB	28	28	45	47	3	5	1.5	1.5	2	1.1	0.3	0.168	
32304	7604E	2FD	28	28	45	47	3	6	1.5	1.5	2	1.1	0.3	0.231	
306/22			26	26	42	44	6.5	9	1	1	2.1	1.1	0.29	0.167	
30205	7205E	3CC	31	31	46	47	3	5	1	1	1.6	0.9	0.37	0.157	
32205		2CD	31	31	44	46	3	4	1	1	1.7	0.9	0.36	0.184	
31305	27305E	7FB	33	33	52	57	3	7	1.5	1.5	0.7	0.4	0.83	0.264	
31305X2/Y82			33	33	52	57	3	7	1.5	1.5	1.1	0.6	0.54	0.267	
30305	7305E	2FB	33	33	55	57	3	5	1.5	1.5	2	1.1	0.3	0.265	
32305	7605E	2FD	33	33	55	57	3	7	1.5	1.5	2	1.1	0.3	0.37	
30305/YB			33	33	55	57	3	5	1.5	1.5	2	1.1	0.3	0.265	
30606(ST3058-1)			34	34	52	56	7	9	1.5	0.3	1.9	1	0.32	0.261	
30206	7206E	3DB	36	36	56	57	3	5	1	1	1.6	0.9	0.37	0.232	
32206	7506E	3DC	36	36	56	57	3	6	1	1	1.6	0.9	0.37	0.285	
30306	7306E	2FB	38	38	64	66	3	7	1.5	1.5	1.9	1	0.31	0.389	
31306	27306E	7FB	38	38	64	66	3	7	1.5	1.5	0.7	0.4	0.82	0.394	
30306X2B	27706		36	36	60	68	5	9	2.5	1	1	0.56	0.6	0.472	
32306	7606E	2FD	38	38	64	66	4	8	1.5	1.5	1.9	1	0.31	0.566	
32306 AN			38	37	59	66	4	6	1.5	1.5	1.9	1	0.31	0.587	
323/32	76/32		39	39	68	71	3	6.5	1.5	1.5	1.1	0.6	0.55	0.647	
32007		3DC	40	41	54	59	4	4	1	1	2.9	1.6	0.2	0.22	
30607		3DB	50	50	56	50	3	5	3	3	1.5	0.8	0.38	0.246	
30207	7207E	3DB	43	43	64	67	3	5	1.5	1.5	1.6	0.9	0.37	0.333	
32207	7507E	3DC	43	43	64	67	3	7	1.5	1.5	1.6	0.9	0.37	0.447	
33207			40	41	62	71	3	7	1.5	1.5	1.7	0.9	0.35	0.518	
30307	7307E	2FB	44	44	71	75	3	7	2	1.5	1.9	1	0.31	0.518	
31307	27307E		42	44	62	76	4	8	3	3	0.7	0.4	0.82	0.517	
32307	7607E	2FE	44	44	71	75	5	10	2	1.5	1.9	1	0.31	0.766	

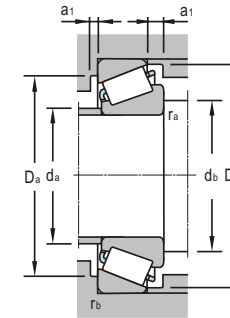
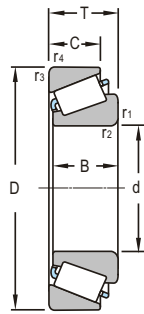

d 35~55mm

Boundary Dimensions							Basic Load Ratings		Limiting Speeds	
d	D	T	B	C	r _{1,2min}	r _{3,4min}	Dynamic C	Static C ₀	Grease	Oil
mm							kN		r/min	
35	80	32.75	31	24	2	1.5	94.7	116	4800	6300
40	62	15.2	14	12	0.6	0.6	30	50	5600	7200
	68	19	19	14.5	1	1	52.6	72.3	5300	7000
	75		26	20.5	1.5	1.5	84.6	110		
	80	19.75	18	16	1.5	1.5	63	74.1	4800	6300
	80	21.5	18	17.75	1.5	1.5	66	80	5300	6600
	80	24.75	23	19	1.5	1.5	77.9	97.5	4800	6300
	80	24.75	23	19	1.5	1.5	77.9	97.5	4800	6300
	90	25.25	23	20	2	1.5	90.8	108.7	4500	6000
	90	25.25	23	17	2	1.5	81.5	96.5	4000	5300
	90	35.25	33	27	2	1.5	115.3	149	4000	5300
	90	35.25	33	26	2	1.5	100	118	4000	5300
45	85	20.75	19	16	1.5	1.5	67.6	84.4	4500	6000
	85	24.75	23	19	1.5	1.5	80.3	105.1	4500	6000
	85	24.75	23	19	1.5	1.5	82	100	4500	6000
	85	25	23.5	20	1.5	1.5	77	93	4500	6000
	85	32	32	25	1.5	1.5	113	147	4000	5300
	100	27.25	25	22	2	1.5	108.7	131.2	4000	5300
	100	32	29	20	1.5	1.5	63	83	4000	5300
47	100	43	43	37	1.5	1	108	169	4000	5300
50	80	20	20	15.5	1.5	1.5	54.5	85	4500	6000
	80	20	20	15.5	1	1	59.1	85	4500	6000
	90	21.75	20	17	1.5	1.5	76.1	97.4	4300	5600
	90	24.75	23	19	1.5	1.5	89.4	120	4300	5600
	90	24.75	23	19	1.5	1.5	88	109	4300	5600
	110	29.25	27	23	2.5	2	129.9	158.9	3600	4800
	110	29.25	27	19	2.5	2	102	128	3200	4300
	110	31.75	29.5	23	2.5	2	136	157	3200	4300
	110	42.25	40	33	2.5	2	177.3	238.7	3200	4300
	110	42.25	40.5	33	2.5	2	190	244	3200	4300
50.8	100	35	35	27	2.5	2.5	140	192	3400	4500
55	90	23	23	17.5	1.5	1.5	75.4	122	4000	5300
	95	30	30	23	1.5	1.5	105	148	3800	5000
	100	22.75	21	18	2	1.5	90.9	115.7	3800	5000
	100	24.75	23	18	2	1.5	90.1	111	3800	5000

Bearing Designations			Mounting Dimensions						Calculation Factors				Mass		
Present	Original	ISO355 Series code	d _{amax}	d _{bmax}	D _{amin}	D _{bmin}	a ₁	a ₂	r _{amax}	r _{bmax}	Y ₁	Y ₂	Y ₀	e	kg
			mm												
32307 CN			43	44	66	74	4	8	2	2	1.9	1	0.31	0.777	
32908X2	2007908		46	46	57	58	3	5	0.6	0.6	2.1	1.1	0.28	0.139	
32008		3DB	46	46	60	65	4	4.5	1	1	1.5	0.8	0.38	0.275	
33100/YB(33100-X19)			46	48	66	70					1.68	0.93	0.36	0.503	
30208	7208E	3DB	48	48	72	75	3	6	1.5	1.5	1.6	0.9	0.37	0.423	
30608	7808E		48	48	72	75	4	7	1.5	1.5	1.6	0.9	0.37	0.446	
32208	7508E	3DC	48	48	72	75	3	8	1.5	1.5	1.6	0.9	0.37	0.529	
32208 R			48	47	68	75	3	6	2	1.5	1.6	0.9	0.37	0.549	
30308	7308E	2FB	49	49	80	85	3	7	2	1.5	1.7	0.9	0.35	0.748	
31308	27308E	7EB	49	49	80	85	6	10	2	1.5	0.7	0.4	0.83	0.729	
32308	7608E	2FD	49	49	80	85	5	10	2	1.5	1.7	0.9	0.35	1	
32308 CN			49	49	73	83	4	8.5	2	2	1.7	0.9	0.35	1.02	
30209	7209E	3DB	53	53	76	79	3	7	1.5	1.5	1.5	0.8	0.4	0.474	
32209	7509E	3DC	53	53	76	79	3	8	1.5	1.5	1.5	0.8	0.4	0.585	
32209R			53	53	76	79	3	8	1.5	1.5				0.4	
32209/YB2	127509		53	53	76	79	3	8	1.5	1.5	1.5	0.8	0.4	0.584	
33209			52	52	72	78	5	7	1	1	1.5	0.8	0.4	0.82	
30309	7309E		54	54	90	94	4	7	2	1.5	1.7	0.9	0.35	0.988	
30309X2B	27709	2FB	51	51	82	96	6	13	1.5	1.5	0.8	0.46	0.7	1.04	
306/47	7909		57	57	86	95	6	8	1.5	1.5	1.9	1.1	0.3	1.66	
32010/YB2			56	56	72	77	4	4.5	1.5	1.5	1.4	0.8	0.42	0.373	
32010		3DC	56	56	72	77	4	4.5	1	1	1.4	0.8	0.42	0.373	
30210	7210E	3DC	58	58	82	85	4	7	1.5	1.5	1.4	0.8	0.43	0.539	
32210	7510E	3DB	58	58	82	85	3	8	1.5	1.5	1.4	0.8	0.43	0.645	
32210 R		3DC	57	57	78	86	3	6	1.5	1.5	1.4	0.8	0.43	0.668	
30310	7310E		60	60	98	103	4	8	2.1	2	1.7	0.9	0.35	1.3	
31310	27310E	2FB	58	60	87	105	4	10.5	3	3	0.7	0.4	0.82	1.22	
30310X2			60	60	98	103	4	8	2.1	2	1.7	0.9	0.35	1.35	
32310	7610E		60	60	98	103	6	12	2.1	2	1.7	0.9	0.35	1.9	
AK32310		2FD	60	60	98	103	6	12	2.1	2	1.7	0.9	0.35	1.91	
33910/YB2			63	63	90	88	3	5	2	2	1.5	0.8	0.4	1.17	
32011	2007111E		63	62	81	86	4	5.5	1.5	1.5	1.5	0.8	0.4	0.561	
33111	3007711	3CE	63	63	81	92	5	7	1.5	1.5	1.6	0.9	0.37	0.862	
30211	7211E	3CE	64	64	90	94	4	7	2	1.5	1.5	0.8	0.4	0.719	
30211 x2		3DB	64	64	88	95	4	5	3	3	1	0.6	0.55	0.76	

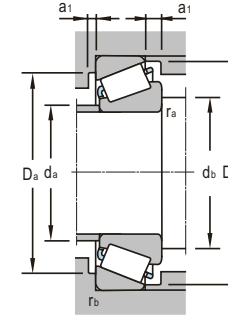
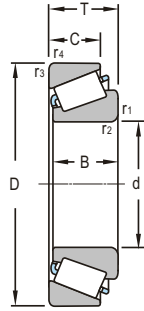

d 55~70mm

Boundary Dimensions							Basic Load Ratings		Limiting Speeds	
d	D	T	B	C	r _{1,2min}	r _{3,4min}	Dynamic C	Static C ₀	Grease	Oil
mm							kN		r/min	
55	100	26.75	25	21	2	1.5	107.5	143.8	3800	5000
	100	35	35	27	2	1.5	3800	5000	3800	5000
	120	31.5	29	21	2.5	2	129.9	158	2800	3800
	120	31.5	29	21	4	3	123	139	2800	3800
	120	31.5	29	25	2.5	2	153.1	189.7	3200	4300
	120	31.5	29	21	2.5	2	123	139	3200	4300
	120	45.5	43	35	2.5	2	202.8	274.3	3000	4000
	120	45.5	43	35	7	2	203	256	3000	4000
	125	37	36	25	3	2	158	209	3000	4000
	130	36	33	22	3	2.5	170	184	2800	3800
60	85	17.3	16	14	1	1	56	83	4000	5300
	95	23	23	17.5	1.5	1.5	79.8	125	3800	5000
	110	23.75	22	19	2	1.5	102.9	131.5	3400	4500
	110	29.75	28	24	2	1.5	132.2	181.5	3400	4500
	110	34.1	30	20	2	2	82	61	5810	7270
	125		33.5	26	3	3	132	176		
	130	33.5	31	26	3	2.5	175	203	3000	4000
	130	33.5	31	26	3	2.5	175	203	3000	4000
	130	33.5	31	22	3	2.5	145.4	176.8	2600	3600
	130	48.5	46	37	3	2.5	226.3	306.1	2600	3600
62	100	21.5	21	16.5	1.5	1.5	70	104	3900	4900
65	100	23	23	17.5	1.5	1.5	84.5	131	3400	4500
	110	34	34	26.5	1.5	1.5	125	202	3200	4300
	120	24.75	23	20	2	1.5	120	154.2	3000	4000
	120	32.75	31	27	2	1.5	163	212	3000	4000
	120	41	41	32	2	1.5	184	257	2800	3800
	120	41	41	32	2	1.5	183	280	2800	3800
	130	45	43	35	7	2	207	306	2600	3600
	140	36	33	28	3	2.5	195.7	244.4	2600	3600
	140	36	33	28	6	2.5	206	243	2600	3600
	140	40	39	26	3	2.5	204	246	2600	3600
	140	39	26	3.5	2.5	2.5	204	246	2600	3600
	140	36	33	23	3	2.5	165.7	202.6	2200	3200
	140	40	38	27	3	2.5	187	247	2600	3600
	140	51	48	39	3	2.5	259.3	353.6	2400	3400
140	51	48	39	3	2.5	248	340	2400	3400	
70	115		29	23	3	2.5	124	194		

Bearing Designations			Mounting Dimensions							Calculation Factors				Mass	
Present	Original	ISO355 Series code	d _{amax}	d _{bmax}	D _{amin}	D _{bmin}	a ₁	a ₂	r _{amax}	r _{bmax}	Y ₁	Y ₂	Y ₀	e	kg
mm															
32211	7511E	3DC	64	64	90	94	4	8	2	1.5	1.5	0.8	0.4	0.86	
33211											1.5	0.8	0.4	1.22	
31311	27311E		65	65	103	114	8	14	2.1	2	0.7	0.4	0.83	1.56	
31311/YB2		7FB	70	65	104	112	4	6.5	3	3	0.7	0.4	0.82	1.56	
30311	7311	2FB	65	65	106	114	4	9	2.1	2	1.7	0.9	0.35	1.63	
30311R			65	65	106	114	4	9	2.1	2	1.7	0.9	0.35	1.69	
32311	7611E	2FD	65	65	106	114	8	14	2.1	2	1.7	0.9	0.35	2.33	
32311/YB2			66	65	99	111	5	10.5	18	18	1.7	0.9	0.35	2.34	
31611		3DB	69	69	107	111	4	11	2.5	2.5	0.8	0.4	0.73	2.11	
30611		2FB	69	69	111	116	4	11	2.5	2.5	0.7	0.4	0.82	2.11	
32912X2	2007912		67	67	78	81	3	5	1	1	1.6	0.9	0.38	0.24	
32012	2007112E	3CE	67	67	85	91	4	5.5	1.5	1.5	1.4	0.7	0.43	0.592	
30212	7212E		69	69	100	104	5	7	2	1.5	1.5	0.8	0.4	0.906	
32212	7512E	3EB	69	69	100	104	4	8	2	1.5	1.5	0.8	0.4	1.18	
		3-706	70	70	100	104	5	14	2	2	1.4	0.7	0.43	1.25	
30312X3			72	78	111	119	4	11	2.5	2.5	0.72	0.4	0.83	2.02	
30312	7312E	2FB	71	71	116	123	4	10	2.5	2.1	1.7	0.9	0.35	2	
30312R			71	71	116	123	4	10	2.5	2.1	1.7	0.9	0.35	2.06	
31312	27312E	7FB	71	71	112	123	8	14	2.5	2.1	0.72	0.4	0.83	2.02	
32312	7612E	7FD	71	71	116	123	8	14	2.5	2.1	1.7	1	0.35	2.91	
306/62	7912		68	71	91	96.9	4	6	1	1	1.6	0.9	0.37	0.597	
32013		3DC	72	72	90	97	4	5.5	1.5	1.5	1.3	0.7	0.46	0.631	
33113			75	75	100	104	4	5	1.5	1.5	1.5	0.8	0.39	1.27	
30213	7213E	3EB	74	74	108	114	5	7	2	1.5	1.5	0.8	0.4	1.13	
32213	7513E	3EC	74	74	108	114	4	8	2	1.5	1.5	0.8	0.4	1.54	
33213	3007213	3EE	76	74	104	111	6	12	2	1.5	1.5	0.8	0.39	2.01	
33213 TN1			77	74	106	114	4	5	3	3	1.5	0.8	0.4	1.91	
30613			70	75	100	104	4	8	3	1.5	1.5	0.8	0.33	2.64	
30313	7313E	7GB	76	76	125	132	5	10	2.5	2.1	1.7	0.9	0.35	2.45	
30313/YB2			76	76	125	132	5	10	2.5	2.1	1.7	0.9	0.35	2.44	
30313X2B			76	76	125	132	5	10	2.5	2.1	1.7	0.9	0.35	2.68	
30613B			76	76	125	132	5	10	2.5	2.1	1.7	0.9	0.35	2.68	
31313	27313E	7GB	76	76	120	132	10	16	2.5	2.1	0.7	0.4	0.83	2.39	
31613?		3DB	79	79	122	126	6	13	2.5	2.5	0.8	0.4	0.73	2.74	
32313	7613E	2GD	76	76	125	132	8	14	2.5	2.1	1.7	1	0.35	3.35	
32313R			76	76	125	132	8	14	2.5	2.1	1.7	1	0.35	3.63	
JM61294U/JM612910			77	83	103	110	5	3	2.5		1.23	0.67	0.49	0.5	

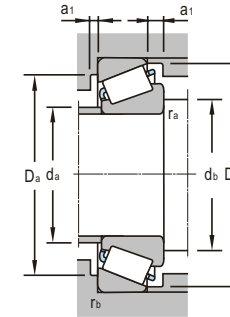
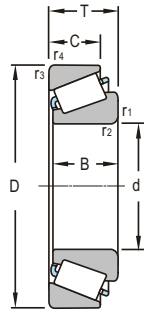

d 70~85mm

Boundary Dimensions							Basic Load Ratings		Limiting Speeds	
d	D	T	B	C	r _{1,2min}	r _{3,4min}	Dynamic C	Static C ₀	Grease	Oil
mm							kN		r/min	
70	120	33	33	27	2	2	151	217	3000	4000
	120	33	33	27	2	2	173	246	3000	4000
	125	26.25	24	21	2	1.5	132	174.3	3000	4000
	125	33.25	31	27	2	1.5	168.1	238	2800	3800
	140		35.5	27	3	3	165	230	2400	3400
	150	38	35	30	3	2.5	218.8	274.7	2400	3400
	150	38	35	30	9	2.5	230	275	2400	3400
	150	38	35	25	5	2.5	197	232	2000	3000
	150	38	35	25	5	2.5	197	232	2000	3000
	150	54	51	42	3	2.5	298.8	413.4	2200	3200
150		51	42	3	2.5	309	401			
75	130	27.25	25	22	2	1.5	137.7	186.9	2800	3800
	130	33.25	31	27	2	1.5	169.5	244.1	2600	3600
	135	44	45	35	2	2	175	274	3000	3800
	135	44.5	45	36.5	2	2	228	339	3000	3800
	135	44.5	45	36.5	2	2	240	370	3000	3800
	160	40	37	26	3	2.5	219	259	1900	2800
	160	40	37	31	3	2.5	250.3	318.6	2200	3200
	160	58	55	45	3	2.5	358	472	2000	3000
	170	61.5	58	48	3	2.5	406	543	1900	2800
	180		60	45	4	3	370	472		
80	110	20	20	16	1	1	72.8	123		
	125	29	29	22	1.5	1.5	136	209	2600	3600
	130	32	31	25	1	3.5	140	233	2500	3500
	140	28.25	26	22	2.5	2	160.1	213.6	2400	3400
	140		33	28	2.5	2	198	263	2600	3400
	140	35.25	33	28	2.5	2	198	280.1	2400	3400
	140	35.5	33	28	2	2	160	241	2400	3400
	140	45	45	36.5	2.5	2	250	380	2200	3200
	165		59.5	43	5	3	333	509		
	170	42.5	39	33	3	2.5	286	343	2000	3000
170	61.5	58	48	3	2.5	400	532	1900	2800	
85	140	77.07	38.5	69.14	2	0.6				
	150	30.5	28	24	2.5	2	180	242.5	2200	3200
	150	38.5	36	30	2.5	2	220	323	2200	3200
	150	49	49	37	2.5	2	272	409	2000	3000
	150		57	37	2	2	298	446		
	180	44.5	41	34	4	3	304.5	392.4	1900	2800

Bearing Designations			Mounting Dimensions						Calculation Factors				Mass		
Present	Original	ISO355 Series code	d _{amax}	d _{bmax}	D _{amin}	D _{bmin}	a ₁	a ₂	r _{amax}	r _{bmax}	Y ₁	Y ₂	Y ₀	e	kg
			mm												
33114X2	7814E	3DE	77	77	110	115	5	10	2	2	2.2	1.2	0.28	1.46	
33114X2/YA			77	77	110	115	5	10	2	2	2.2	1.2	0.28	1.55	
30214	7214E	3EB	79	79	114	119	5	7	2	1.5	1.4	0.8	0.42	1.26	
32214	7514E	3EC	79	79	114	119	4	8	2	1.5	1.4	0.8	0.42	1.65	
30314X3			82	82	106	133	5	12	2.5	2.5	0.68	0.4	0.88	2.6	
30314	7314E	2GB	81	81	135	142	5	10	2.5	2.1	1.7	0.9	0.35	2.99	
30314/YB2			81	81	135	142	5	10	2.5	2.1	1.7	0.9	0.35	2.97	
31314			89	82	130	141	5	8	4	4	0.7	0.4	0.82	2.91	
31314/YB2			89	82	130	141	5	8	4	4	0.7	0.4	0.82	2.91	
32314	7614E	2GD	81	81	135	142	8	14	2.5	2.1	1.7	1	0.35	4.43	
32314/YB3			81	81	135	142	8	14	2.5	2.1	1.7	1	0.35	4.33	
30215	7215E	4DB	84	84	119	124	5	7	2	1.5	1.4	0.8	0.44	1.38	
32215	7515	4DC	84	84	119	124	4	8	2	1.5	1.4	0.8	0.44	1.74	
30615/YB2			82	85	119	131	5	11	2	2	2.2	1.2	0.28	2.57	
30615			82	85	119	131	5	11	2	2	2.2	1.2	0.28	2.69	
30615/YA			86	86	120	125	5	11	2	2	2.5	1.4	0.24	2.76	
31315			91	87	127	148	6	14	2	2	0.72	0.4	0.83	3.5	
30315	7315E	2GB	86	86	143	152	5	11	2.5	2.1	1.7	0.9	0.35	3.58	
32315	7615E	2GD	86	86	143	152	10	16	2.5	2.1	1.7	1	0.35	5.32	
T6GD075			90	90	152	162	10	16	2.5	2.1	1.7	0.9	0.35	6.64	
32315X3			86	94	152	166					0.85	0.47	0.7	7.68	
32916														0.538	
32016		3EB	89	87	112	120	6	7	1.5	1.5	1.6	0.8	0.42	1.27	
30616/YB2			86	86	119	124	5	7	1	1	1.6	0.8	0.38	1.56	
30216	7216E	3EB	90	90	127	134	5	8	2.1	2	1.4	0.8	0.42	1.84	
32216			90	90	127	134	5	8	2.1	2	1.4	0.8	0.42	2.03	
32216	7516E	3EC	90	90	127	134	5	8	2.1	2	1.4	0.8	0.42	2.03	
32216/YB2	7516		90	90	127	134	5	8	2	2	1.5	0.8	0.4	2.15	
30616			87	90	127	135.7	5	11	2.1	2	2.2	1.2	0.28	2.81	
31316X2			90	104	138	152					0.88	0.48	0.68	6.05	
30316	7316E	2GB	92	92	152	162	7	12	2.5	2.1	1.7	0.9	0.35	4.5	
32316	7616E	2GD	92	92	152	162	10	16	2.5	2.1	1.7	0.9	0.35	6.39	
	B3-748L		95	95		130			2	2	1.8	1	0.33	3.32	
30217	7217E	3EB	95	95	136	144	5	9	2.1	2	1.4	0.8	0.42	2.06	
32217	7517E	3EC	95	95	136	144	5	11	2.1	2	1.4	0.8	0.42	2.67	
33217	3007217	3EE	95	95	136	145	7	12	2.1	2	1.4	0.8	0.42	3.57	
33217WB1			108	106	128	140					1.43	0.78	0.42	3.94	
30317	7317E	3GB	97	97	161	171	8	14	3	2.5	1.7	0.9	0.35	5.305	

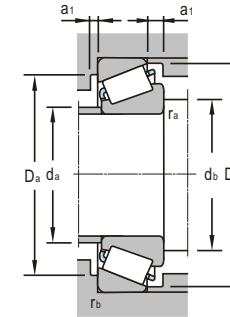
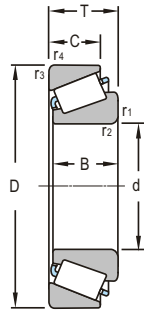

d 85~105mm

d	Boundary Dimensions						Basic Load Ratings		Limiting Speeds	
	D	T	B	C	r _{1,2min}	r _{3,4min}	Dynamic C	Static C ₀	Grease	Oil
mm										
kN										
r/min										
85	180	44.5	41	28	4	3	266	320	1800	2600
	180	63.5	60	49	4	3	434	580	1800	2600
90	140		32	24	5	1.5	159	245	2200	3200
	140	32	32	24	2	1.5	159	245	2200	3200
	140	32.4	30	26	2	1.5	160	257	2200	3200
	140	32.4	30	26	2	1.5	130	210	2200	3200
	150	45	45	35	2.5	2	231	396	2000	3000
	160	32.5	30	26	2.5	2	199.7	270.5	2000	3000
	160	42.5	40	34	2.5	2	269.1	396.9	2000	3000
	190	46.5	43	36	4	3	341.7	445.7	1800	2600
	190	67.5	64	53	4	3	477.7	690.8	1700	2400
95	145	32	32	24	2	1.5	162	255	2200	3200
	145	32.4	30	26	2	1.5	226.1	310.2	2200	3200
	160	47	47	38	3	2.5	251	420	3970	4970
	160	47	47	38	3	2.5	299	498	3970	4970
	170	34.5	32	27	3	2.5	226.1	310.2	1900	2800
	170	45.5	43	37	3	2.5	313	443	1900	2800
	170	58	58	44	3	2.5			1900	2800
	200	49.5	45	38	4	3	368.6	483	1800	2600
	200	71.5	67	55	4	3	515.5	745.8	1700	2400
100	130	57	56	35	11	2	238	327		
	150	32	32	24	2	1.5	165	265	2000	3000
	150	32.4	30	26	2	1.5	163	266	2000	3000
	150	32.4	30	26	2	1.5	150	261	2000	3000
	165	47	46	39	3	3	305	486	1900	2800
	180	37	34	29	3	2.5	253.3	351.6	1900	2800
	180	49	46	39	3	2.5	340.2	513.7	1800	2600
	180	63	63	48	3	3			1700	2400
	215	51.5	47	39	4	3	406	532.3	1700	2400
	215	77.5	73	60	4	3	599.5	881.9	1600	2200
105	160	35	35	26	2.5	2	194	311	1900	2800
	160	43	43	34	2.5	2	240	398	1900	2800
	170		38	29	3	3	226	326		
	190	39	36	30	3	2.5	284.6	400	1800	2600
	190	53	50	43	3	2.5	380.1	581.2	1800	2600
	225	53.5	49	41	4	3	432.6	568.1	1600	2200
	225	81.5	77	63	4	3	646.4	955.6	1500	2000

Bearing Designations			Mounting Dimensions						Calculation Factors				Mass		
Present	Original	ISO355 Series code	d _{amax}	d _{bmax}	D _{amin}	D _{bmin}	a ₁	a ₂	r _{amax}	r _{bmax}	Y ₁	Y ₂	Y ₀	e	kg
mm															
31317			103	99	143	169	6	16.5	2.5	2.5	0.72	0.4	0.83		4.6
32317	7617E	2GD	98	98	161	171	12	18	3	2.5	1.7	0.9	0.35		6.81
32018/YB			100	99	125	134	6	8	2	2	1.4	0.8	0.42		1.66
32018		3EB	100	99	125	134	6	8	2	2	1.4	0.8	0.42		1.7
32018 X2/YA	2007118		99	99	128	134	5	8	2	1.5	1.8	1	0.34		1.66
32018 RX2			100	99	125	134	6	8	2	2	1.7	0.9	0.34		1.7
33118TM1			102	102	134	138	5	10	2	2	1.5	0.8	0.4		2.97
30218	7218E	3FB	100	100	145	153	5	9	2.1	2	1.4	0.8	0.42		2.558
32218	7518E	3FC	100	100	145	153	5	11	2.1	2	1.4	0.8	0.42		3.33
30318	7318E	2GB	103	103	170	181	8	14	3	2.5	1.7	0.9	0.35		6.144
32318	7618E	2GD	103	103	170	181	12	18	3	2.5	1.7	0.9	0.35		8.76
32019		3EB	105	104	130	140	6	8	2	2	1.3	0.7	0.45		1.77
32019 X2/YA	2007119		104	104	133	139	5	8	2	1.5	1.7	0.9	0.36		1.7
30619		3FB	109	109	145	146	5	9	2.5	2.5	2	1.1	0.29		3.7
33119X2/YB			109	109	145	146	5	9	2.5	2.5	2	1.1	0.29		3.87
30219	7219E	3FB	106	106	157	163	5	10	2.5	2.1	1.4	0.8	0.42		3.269
32219	7519E	3FC	106	106	157	163	5	11	2.5	2.1	1.4	0.8	0.42		4.216
33219			106	106	157	163	5	11	2.5	2.1					
30319	7319E	2GB	109	109	180	191	8	14	3	2.5	1.7	0.9	0.35		7.13
32319	7619E	2GD	109	109	180	191	14	20	3	2.5	1.7	0.9	0.35		10.73
LY-3026															2.99
32020		3EB	109	109	134	144	6	8	2	2	1.3	0.7	0.46		1.84
32020 YB2	2007120		109	109	138	144	5	8	2	1.5	1.6	0.9	0.37		1.79
32020 RX2			109	109	134	144	6	8	2	2	1.6	0.9	0.37		1.8
33120X2			111	111	145	160	5	10	2.5	2.5	1.9	1	0.32		3.93
30220	7220E	3FB	111	111	162	172	5	10	2.5	2.1	1.4	0.8	0.42		3.73
32220	7520E	3FC	111	111	162	172	5	14	2.5	2.1	1.4	0.8	0.42		5.12
33220/YB2			111	111	162										
30320	7320E	2GB	116	116	194	205	10	16	3	2.5	1.7	0.9	0.35		8.69
32320	7620E	2GD	116	116	194	205	14	20	3	2.5	1.7	0.9	0.35		12.96
32021		3EB	116	115	143	154	6	9	2	2	1.3	0.7	0.44		2.38
33021		3EB	116	115	143	154	6	9	2	2	1.3	0.7	0.46		2.94
32021X3			115	122	155	162					1.39	0.76	0.43		3.23
30221	7221E	2FB	116	116	172	182	6	11	2.5	2.1	1.4	0.8	0.42		4.936
32221	7521E	3FC	116	116	172	182	6	12	2.5	2.1	1.4	0.8	0.42		6.495
30321	7321E	2GB	120	120	202	215	10	16	3	2.5	1.7	0.9	0.35		9.912
32321	7621E	2GD	123	123	202	215	14	20	3	2.5	1.7	0.9	0.35		14.458

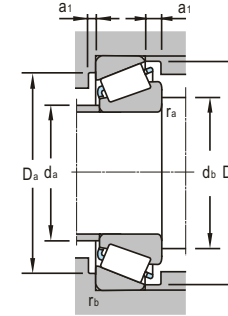
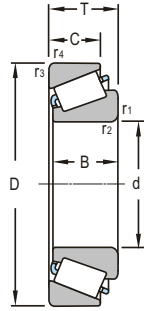

d 110~160mm

Boundary Dimensions						Basic Load Ratings		Limiting Speeds		
d	D	T	B	C	r _{1,2min}	r _{3,4min}	Dynamic C	Static C ₀	Grease	Oil
mm						kN		r/min		
110	170	38	38	29	2.5	2	202	354	1800	2800
	170	47	47	37	2.5	2	266	464	1800	2800
	180	41	46	38	3	2.5	297	489		
	200	41	38	32	3	2.5	314.1	445.1	1700	2400
	200	56	53	46	3	2.5	430.7	668.6	1700	2400
	240	54.5	50	42	4	3	471.6	619.1	1600	2200
	240	84.5	80	65	4	3	722.8	1075.9	1400	1900
120	180	38	38	29	2.5	2	230	394	1700	2400
	180	38	38	29	2.5	2	230	394	1800	2400
	180	38.4	36	31	2.5	2	230	394	1700	2400
	180	38.4	36	31	2.5	2	230	394	1700	2400
	180	48	48	38	2.5	2	283	514	1700	2400
	215	43.5	40	34	3	2.5	335.8	487.2	1600	2200
	215	61.5	58	50	3	2.5	492	741	1600	2200
	260	59.5	55	46	4	3	562	754.3	1500	2000
	260	90.5	86	69	4	3	824.8	1239.3	1300	1800
130	200		45	34	1.2	2	316	528	1600	2200
	200	45	45	34	2.5	2	309	513	1600	2200
	230	43.75	40	34	4	3	364.3	525.6	1500	2000
	230	44.5	40	34	4	3	351	466	1500	2000
	230	67.75	64	54	4	3	561	855	1500	2000
	280	63.75	58	49	5	4	639.3	864.5	1300	1800
140	190	32	32	25	2	1.5	207	390	1600	2200
	210	45	45	34	2.5	2	314	533	1600	2200
	210	45.5	42	36	2.5	2	285	460	1600	2200
	210	45.5	42	36	2.5	2	259	460	1600	2200
	250	45.75	42	36	4	3	407.3	589.4	1400	1900
	250	71.75	68	58	4	3	657	1020	1400	1900
150	210		38	30	3	2.5	241	439	1500	2000
	225	48	48	36	3	2.5	361	621	1500	2000
	225	48	48	36	3	2.5	377	659	1400	2000
	270	49	45	38	4	3	495	687	1300	1800
	270	77	73	60	4	3	718	1191.4	1200	1700
	300	67.75	62	53	5	4	721.8	985.5	1200	1700
	320	115	108	90	5	4	1010	1580	950	1400
160	240	51	51	38	3	2.5	420	740	1300	1800

Bearing Designations			Mounting Dimensions						Calculation Factors				Mass		
Present	Original	ISO355 Series code	d _{amax}	d _{bmax}	D _{amin}	D _{bmin}	a ₁	a ₂	r _{amax}	r _{bmax}	Y ₁	Y ₂	Y ₀	e	kg
			mm												
32022		3DC	122	120	152	163	7	9	2	2	1.4	0.7	0.43		3.01
33022		3EB	122	120	152	163	7	9	2	2	2.1	1.1	0.29		3.76
UNH5202ASU/UNH5201S			122	127	172	162	10	6.5	3	2.5	1.48	0.81	0.41		4.6
30222	7222E	3FB	121	121	181	192	6	11	2.5	2.1	1.4	0.8	0.42		5.422
32222	7522E	3FC	121	121	181	192	6	12	2.5	2.1	1.4	0.8	0.42		7.86
30322	7322E	2GB	124	124	215	230	10	16	3	2.5	1.7	0.9	0.35		11.45
32322	7622E	2GD	127	127	215	230	18	25	3	2.5	1.7	0.9	0.35		18.78
32024/YA	2007124 K		131	130	161	173	7	9	2	2	1.6	0.9	0.37		3.07
32024/YA			131	130	161	173	7	9	2	2	1.6	0.9	0.37		3.07
32024 X2R			131	130	161	173	7	9	2	2	1.6	0.9	0.37		3.14
32024 X2/YA	2007124		130	130	166	174	6	9	2.1	2	1.6	0.9	0.37		3
33024			130	131	161	173	7	12	2	2	1.9	1	0.31		1.09
30224	7224E	4FB	131	131	196	207	7	12	2.5	2.1	1.4	0.8	0.44		6.125
32224	7524E	4FD	131	131	196	207	8	12	2.5	2.1	1.4	0.8	0.44		9.25
30324	7324E	2GB	137	137	235	250	10	16	3	2.5	1.7	0.9	0.35		13.7
32324	7624E	2GD	138	138	235	250	18	25	3	2.5	1.7	0.9	0.35		21.7
32026			144	140	178	192	8	11	2	2	1.3	0.7	0.43		4.9
32026		3EB	144	140	178	192	8	11	2	2	1.3	0.7	0.43		4.9
30226	7226E	4FB	142	142	208	222	7	12	3	2.5	1.4	0.8	0.44		7.24
30226 X2	7226	4FB	142	142	208	222	7	12	3	2.5	1.4	0.8	0.44		7.25
32226	7526E	4FD	142	142	208	222	10	16	3	2.5	1.4	0.8	0.44		11.37
30326	7326E	2GB	148	148	250	267	14	18	4	3	1.7	0.9	0.35		17.1
32928/YB			146	146	177	187	4	8	2	1.5	1.7	0.9	0.36		2.49
32028		3EB	153	150	187	202	8	11	2	2	1.3	0.7	0.46		5.14
32028 X2	2007128		153	150	187	202	8	11	2	2	1.6	0.9	0.37		5.1
32028 X2L/YA	2007128L		153	150	187	202	8	11	2	2	1.6	0.9	0.37		5.72
30228	7228E	4FB	153	153	226	241	7	12	3	2.5	1.4	0.8	0.44		8.892
32228	7528E	4FD	153	153	226	241	10	16	3	2.5	1.4	0.8	0.44		14.68
32930			163	165	196	202	7	8	2	2	1.8	1	0.33		3.94
32030		3EB	164	162	200	216	8	12	2.5	2.5	1.3	0.7	0.46		6.38
32030T/P6			164	162	200	216	8	12	2.5	2.5	1.3	0.7	0.46		6.45
30230	7230E	4GB	164	164	248	260	8	14	3	2.5	1.4	0.8	0.44		10.3
32230	7530E	4GD	164	164	248	260	14	20	3	2.5	1.4	0.8	0.44		18.2
30328	7328E	2GB	159	159	270	288	14	18	4	3	1.7	0.9	0.35		21.7
32330	7630		172	172	287	305	20	30	4	3	1.9	1.1	0.31		37.1
32032/YA4	2007132K	4GD	175	172	213	231	8	13	2.5	2.5	1.6	0.9	0.37		7.16

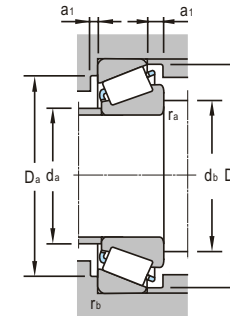
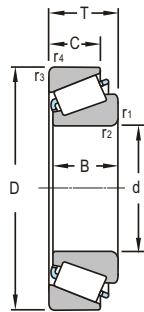

d 160~240mm

Boundary Dimensions							Basic Load Ratings		Limiting Speeds	
d	D	T	B	C	r _{1,2min}	r _{3,4min}	Dynamic C	Static C ₀	Grease	Oil
mm							kN		r/min	
160	240	51.5	48	41	3	2.5	380	634	1300	1800
	290	52	48	40	4	3	556	774	1100	1600
	290	84	80	67	4	3	852.6	1446.1	1000	1400
170	240		44.5	37	3	2.5	341	672		
	260	57	57	43	3	2.5	473	815	1200	1700
	360	127	120	100	5	4	1280	2080	850	1100
180	280	64	64	48	3	2.5	611	1070	1100	1600
	280	64.5	60	52	3	2.5	550	928	1100	1600
	320	91	86	71	5	4	998.1	1727.3	950	1400
190	260	45	45	34	2.5	2	335	699	1100	1600
	290	64	64	48	3	2.5	605	1070	1000	1500
	290	64.5	60	52	3	2.5	511	970	1000	1500
	290	64.5	60	52	3	2.5	511	970	1000	1500
	290	64.5	60	52	3	2.5	511	970	1000	1500
	340	97	92	75	5	4	1117	1919.5	900	1300
200	300		62	51	3.5	2.5	598	1140		
	300	55	51	45	5	4	519	909		
	310	70	70	53	3	2.5	703	1240	950	1400
	310	70.5	70	53.5	3	2.5	950	1400	950	1400
	360	104	98	82	5	4	1309.4	2203.8	900	1300
205	485	117.5	95.2	73	4	4	1418	1750	770	960
220	290		33	25	3	2.5	239	543		
	340	76.5	72	62	4	3	726	1380	900	1300
	400	73	65	54	4	3	770	1160	850	1200
	400	73	65	54	4	3	941	1330	850	1200
	400	115	108	90	4	3	1530	2565	800	1100
	400	115	108	90	4	3	1230	2280	800	1100
	460	154	145	122	5	5	2130	3390	750	1000
240	320	51.5	48	41	3	2.5	407	804	900	1300
	320	52.5	52.5	39	3	2.5	473	975	900	1300
	360	76	76	57	4	3	709	1560	850	1200
	440	127	120	100	4	4	1843	3183	750	1000
	500	165	155	132	5	5	2660	4290	670	900

Bearing Designations			Mounting Dimensions						Calculation Factors				Mass		
Present	Original	ISO355 Series code	d _{amax}	d _{bmax}	D _{amin}	D _{bmin}	a ₁	a ₂	r _{amax}	r _{bmax}	Y ₁	Y ₂	Y ₀	e	kg
			mm												kg
32032X2			175	172	213	231	8	13	2	2	1.3	0.7	0.46	7.41	
30232	7232E	4GB	175	175	265	279	8	14	3	2.5	1.4	0.8	0.44	12.9	
32232	7532E	4GD	175	175	265	279	14	20	3	2.5	1.4	0.8	0.44	21.1	
JM7344RS/JM7344IS			180	185	222	232	10	6	3	2.5	1.37	0.75	0.44	6.35	
32034		3EB	187	182	230	249	10	14	2.5	2.5	1.4	0.8	0.44	10.2	
32334	7634		192	192	326	344	20	30	4	3	1.7	0.9	0.36	58.3	
32036	2007136		199	192	247	268	10	16	2.5	2.5	2.1	1.2	0.28	14	
32036 X2		4GD	199	192	247	267	10	16	2.5	2.5	2.1	1.2	0.28	13.5	
32336	7536E	4GD	196	196	292	308	18	25	4	3	1.3	0.7	0.45	29.8	
32938			202	202	231	248	8	11	2	2	1.25	0.7	0.48	6.76	
32038			202	202	268	282	8	14	2.5	2.1	2.1	1.1	0.29	14.1	
32038 X2/YA	2007138		209	202	257	279	10	16	2.5	2.5	2.1	1.1	0.29	14.1	
32038 X2/HN YA	2007138N		209	202	257	279	10	16	2.5	2.5	2.1	1.1	0.29	14.1	
32038 X2N/YA	2007138N		209	202	257	279	10	16	2.5	2.5	2.1	1.1	0.29	14.1	
32238	7538E	4GD	208	208	309	328	18	25	4	3	1.4	0.8	0.44	36.1	
JM8044RS/JM8044IS			215	223	273	289	14	8	3.5	2.5	1.15	0.63	0.52	15.5	
LY-3023			222	212	273	297	11	17	2.5	2	1.4	0.8	0.43	18.6	
32040			222	212	273	297	11	17	2.5	2	1.4	0.8	0.43	18.7	
32040X2			231	218	302	340	11	22	4	3	1.5	0.8	0.41	43.2	
32240	7540E	3GD	231	218	302	340	11	22	4	3	1.5	0.8	0.41	43.2	
30641	7841		247	279	410	454	20	30	3	3	0.7	0.4	0.87	90.8	
LY-312(Z33)			242		278						1.41	0.77	0.43	5.74	
32044 X2	2007144		234	234	314	331	10	16	3	2.5	1.7	0.9	0.35	22.2	
31244X2			244	244	367	385	14	20	3	2.5	1.6	0.9	0.37	35.4	
30244 X2	7244		244	244	367	385	20	30	3	2.5	1.5	0.8	0.39	48.1	
32244	7544		238	238	381	382	12	24	3	3	1.5	0.8	0.39	48.1	
32244 X2			260	260	408	430	20	35	4	4	1.6	0.9	0.37	40.6	
32344															
32948/YB2														10.7	
32948X2														10.9	
32048			261	254	318	346	12	19	3	3			0.36	25.8	
32248	7548E		262	262	393	425	20	30	3	3	1.4	0.8	0.44	81.3	
32348			272	272	440	470	20	35	4	4	1.6	0.9	0.37	148	

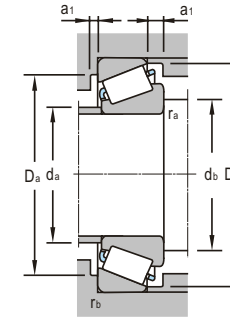
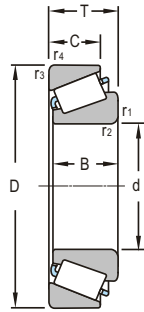

d 241~400mm

Boundary Dimensions							Basic Load Ratings		Limiting Speeds	
d	D	T	B	C	r _{1,2min}	r _{3,4min}	Dynamic C	Static C ₀	Grease	Oil
mm							kN		r/min	
241	360	76	76	57	4	3	709	1560	850	1200
255	560	123.8	104.8	70	6	6	1816	2380	620	770
260	360	64.5	60	52	3	2.5	654	1290	800	1100
	400	87	87	65	5	4	110	2120	700	950
	400	87.7	82	71	5	4	917	1849	800	1100
	540	114	102	85	6	6	2014	2898	670	900
280	350	36	33	26	2	2	259	614	870	1100
	380	63.5	63.5	48	3	2.5	601	1430	800	1000
	380	64.5	60	52	3	2.5	601	1430	800	1000
300	380		38	30	3	2.5	399	931		
	420	76.5	72	60.5	4	3	998	2128	700	950
	460	100	100	74	5	4	1470	2840	560	700
	460		100	74	5	4	1470	2840	670	900
	460	100.7	95	82	5	4	803	1722	560	700
	440	73	70	55	4	3	959	2062	570	600
	500	95	90	70	4	4	1225	2207	530	670
540	149	140	115	6	5	2740	4780	530	670	
304.8	546.1	171.053	171.053	140.097	8	8	2660	3020	530	670
320	440	76.5	72	62	4	3	607	1375	650	870
	480	100.7	95	82	5	4	1463	2945	630	850
	480		100	74	5	4	1450	2890	630	850
330.2	482.64	87	75	68	3	3	863	1526	530	670
340	460	76.5	72	62	4	3	611	1428	530	670
	520	86	82	64	4	3	807	1540	500	630
	520	100	95	75	5	5	1510	2940		
360	480	76.5	72	62	4	3	634	1526	500	630
	540	86	82	64	4	4	919	1848	480	600
380	520	66.5	65	46.5	3	3	529	1138	480	600
	620	112	106	76	4	4	909	1708	400	500
400	540	70	65	48	5	4	811	1658	980	1220

Bearing Designations			Mounting Dimensions							Calculation Factors				Mass	
Present	Original	ISO355 Series code	d _{amax}	d _{bmax}	D _{amin}	D _{bmin}	a ₁	a ₂	r _{amax}	r _{bmax}	Y ₁	Y ₂	Y ₀	e	kg
			mm												
32048/YA2			261	254	318	346	12	19	3	3				0.36	25.6
30651	7851		300	338	480	523	30	40	5	5	0.7	0.4	0.87		129
32952X2			277	277	370	384	10	16	4	3	1.4	0.8	0.43		18.6
32052			277	277	370	386	12	18	4	3	2	1.1	0.3		38.3
32052 X2	2007152		301	301	490	506	20	30	5	5	2.6	1.4	0.23		36.9
30352 X2	7352														111
30656	1007856		295	295	336	342	6	9	2	2	1.4	0.8	0.43		6.33
32956	2007956	4EC	298	298	348	368	11	16	2.5	2.1	1.4	0.8	0.43		19.8
32956/YB2	2007956K		300	325	348	368	11	16	2.5	2.1	2.1	1.1	0.29		19.8
LY-3122[245]			324		366						1.41	0.77	0.43		9.98
32960/YB2	2007960		317	317	394	408	10	16	3	2.5	2.1	1.2	0.28		28.7
32060			320	320	425	445	20	30	4	3	1.4	0.8	0.43		57.2
32060/YA			330	327	408	439	15	26	4	3	1.4	0.76	0.43		57
32060/YB2	2007160		320	320	425	445	14	20	4	3	1.9	1.1	0.31		55.9
30660	7860		318	318	406	426	14	20	3	2.5	1.4	0.8	0.44		30.7
31160 X2	1007760		327	327	460	480	20	30	3	3	1.9	1	0.32		67.7
32260/HCYA			330	330	485	515	20	35	5	4	1.4	0.8	0.43		143
306/304.8/HC			316	316		534			18	18				0.34	175
32964	2007964		335	335	412	427	10	16	3	2.5	2	1.1	0.3		44.7
32064/YB2	2007164		340	340	440	468	14	20	4	3	1.4	0.8	0.42		59
32064/YA			350	347	430	461	15	26	4	3	1.3	0.72	0.46		60.4
306/330.2	7766		351	351	449	462	20	30	2.5	2.5	1.9	1.1	0.31		37.2
32968/YB2	2007968		356	356	432	448	10	16	3	2.5	1.9	1.1	0.31		34.3
32068 X2	7168		360	360	486	501	18	25	3	3	2.1	1.1	0.29		57
30668															73.4
32972/YB2	2007972		376	376	452	468	10	16	3	2.5	1.8	1	0.33		35.9
31072 X2	7172		380	380	504	522	18	25	3	3	2	1.1	0.3		60.5
31976 X2	1007976		402	402	486	505	15	20	2.5	2.5	1.4	0.8	0.42		37.5
31176 X2	1007776		420	420	534	560	10	40	3	3	1.3	0.7	0.46		114
31980			422	422	499	518	16	16	4	4	1.3	0.7	0.44		40.6

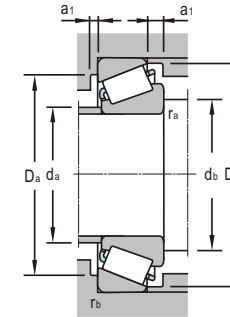
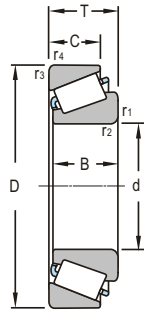

d 400~1800mm

Boundary Dimensions							Basic Load Ratings		Limiting Speeds	
d	D	T	B	C	r _{1,2min}	r _{3,4min}	Dynamic C	Static C ₀	Grease	Oil
mm							kN		r/min	
400	600	95	90	67	4	4	1040	2128	400	500
420	560	70	65	51	3	3	630	1383	400	500
	620	95	90	70	4	4	1132	2422	380	480
	700	130	122	92	6	6	1620	2800	310	420
440	620	95	90	67	2.3	5	1440	2930	340	650
	650	96.4	94	67	6	4	1193	2422	360	450
460	620	80	74	58	3	3	836	1843	380	480
	660	115	110	90	5	4	1960	4650		
	680	105	100	78	6	6	1680	3550	330	450
480	650	84.2	78	60	4	4	854	1918	340	430
	950		220	160	9.5	9.5	5910	10700		
500	720	110	100	82	6	6	1459	3192	280	360
530	670	100.47	95	82	5	3	1850	4800		
	710	88	82	62	4	4	1001	2380	280	360
560	750	92.5	85	64	4	4	1001	2576	240	320
	820	121	115	84	6	6	1887	4046	220	300
600	870	124	118	89	6	6	2020	4438	180	240
630	920	135	128	94	7.5	7.5	2315	5222	170	220
710	950	114	106	80	6	6	1765	4494	150	190
800	990	57	55	45	5	5	907	2644	150	190
	1060	122	115	89	6	6	2132	5530	130	170
900	1180	124	122	87	6	6	2173	5782	95	130
	1280	190	170	135	7.5	7.5	5615	13913	95	130
950	1250	140	132	100	7.5	7.5	3930	10427	80	100
1800	2300	260	218	180	15	15	10810	34000		

Bearing Designations			Mounting Dimensions							Calculation Factors				Mass	
Present	Original	ISO355 Series code	d _{amax}	d _{bmax}	D _{amin}	D _{bmin}	a ₁	a ₂	r _{amax}	r _{bmax}	Y ₁	Y ₂	Y ₀	e	kg
			mm												
31080 X2	7180		420	420	560	580	20	30	3	3	1.5	0.8	0.39	84	
31984 X2	1007984		440	440	532	546	15	20	2.5	2.5	1.9	1.1	0.31	42.4	
31084 X2	7184		448	448	579	601	20	30	3	3	1.5	0.8	0.41	88	
31184 X2	107784		490	490	606	646	15	40	5	5	1.9	1	0.32	183	
32988 X1/P5			465	465	585	592	20	30	2	4	1.5	0.8	0.41	79.4	
31088 X2	7188		469	469	606	629	20	30	5	3	1.4	0.8	0.43	99	
31992 X2	1007992		480	480	590	605	18	25	2.5	2.5	1.5	0.8	0.4	59.8	
32996X3															
31092 X2	7192		516	516	610	640	8	34	5	5	1.9	1.1	0.3	118	
31996 X2	1007996		502	502	613	633	18	25	3	3	1.4	0.8	0.42	71	
31396X3/HC			548	595	851	903			8	8	1.2		0.67	0.49	714
310/500 X2	71/500		530	530	674	700	20	30	5	5	1.8	1	0.33	135	
329/530 X2			552	552	637	658	20	30	4	4				0.38	81.3
319/530 X2	10079/530		554	554	672	693	20	30	3	3	1.5	0.8	0.41	94.8	
319/560 X2	10079/560		586	586	708	731	20	30	3	3	1.4	0.8	0.44	104	
310/560 X2	71/560		594	594	768	795	30	40	5	5	1.5	0.8	0.39	191	
310/600 X2	71/600		630	630	821	845	30	40	5	5	1.5	1.6	0.41	235	
310/630 X2	71/630		669	669	858	891	30	40	6	6	1.4	0.8	0.42	278	
319/710 X2	10079/710		743	743	895	925	25	35	5	5	1.3	0.7	0.46	210.24	
308/800 R/YB2P6			822	822	930	968	25	35	4	4	1.5	0.8	0.39	96.3	
319/800 X2	10079/800		838	838	1005	1031	25	35	5	5	1.7	0.9	0.35	275	
319/900 X2	10079/900		940	940	1117	1146	30	40	5	5	1.5	0.8	0.39	330	
320/900 X2	71/900		944	944	1194	1246	45	60	6	6	1.1	0.6	0.54	703	
319/950 X2	10079/950		994	994	1191	1220	30	40	6	6	1.8	1	0.33	428	
306/1800			1824	1824	2191	2276	30	40	32	32	0.9	0.5	0.67	2339	

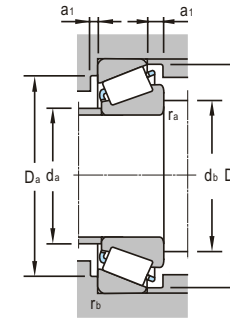
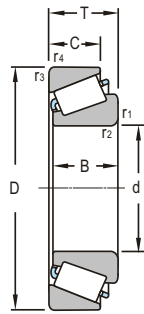

d 17.46~39.69mm

Boundary Dimensions							Basic Load Ratings		Limiting Speeds	
d	D	T	B	C	r _{1,2min}	r _{3,4min}	Dynamic C	Static C ₀	Grease	Oil
mm							kN		r/min	
17.46	39.88	13.84	14.61	10.67	1.3	1.3	22.5	22.5	9000	13000
19.05	45.24	15.49	16.64	12.07	1.3	1.3	28.9	28.9	8500	12000
21.43	50.00	17.53	18.29	13.97	1.3	1.3	36.9	38	8000	11000
21.99	45.24	15.49	16.64	12.07	1.3	1.3	26.9	33.6	9270	11590
	45.97	15.49	16.64	12.07	1.3	1.3	27.5	31	8000	11000
22	45.24	15.49	16.64	12.07	1.3	1.3	27.5	31	8000	11000
	49.23			11		1	16.4	18.4		
25.4	50.00	13.50	14.26	9.53	1	1	27	29	7500	10000
	50.29	14.22	14.73	10.67	1.3	1.3	26	30	7500	10000
26.99	50.29	14.22	14.73	10.67	3.5	1.3	26	32.2	7500	10000
29	50.29	14.22	14.73	10.67	3.5	1.3	26	33	7000	9500
	58			17		4	16.4	18.4		
30.16	64.29	21.43	21.43	16.67	1.5	1.5	48	66.5	6750	8430
31.75	59.13	15.88	16.76	11.81	3.6	1.3	34.7	43	6300	7500
	59.13	15.88	16.76	11.81	3.6	1.3	32.8	43	10410	13010
	62	18.16	19.05	14.29	3.5	1.3	45.8	60.1	6300	8500
	68.26	22.23	22.23	17.46	3.5	1.5	53.1	64.8		
	69.01	19.85	19.58	15.88	3.5	1.3	51.2	65.4	9060	11320
34.93	65.09	18.03	18.29	13.97	3.6	1.3	47.3	58.2	5600	7500
	80.17	29.37	30.39	23.81	3.5	3.2	91.9	106	5000	6700
34.99	59.13	15.88	16.76	11.94	3.6	1.3	32.2	47.3		
	59.98	15.88	16.76	11.94	3.6	1.3	32.2	47.3	6710	8390
37.99	62.98	17	17	13.5	3.6	1.3	40	55	5600	7500
38.1	76.2	23.81	25.65	19.05	3.5	3.2	74.8	93	5000	6700
39.69	73.03	25.65	22.10	21.34	0.8	2.3	66	86.5	5000	6700

Bearing Designations		Mounting Dimensions								Calculation Factors				Mass
Present	Original	d _{amax}	d _{bmax}	D _{amin}	D _{amin}	a ₁	a ₂	r _{amax}	r _{bmax}	Y ₁	Y ₂	Y ₀	e	kg
		mm												
LM11749/LM11710	LM11749/LM11710	21.5	23	34	37	2	3	1	1.3	2.1	1.15	0.29		0.0833
LM11949/LM11910	LM11949/LM11910	23.5	25	39.5	41.5	2	4	1	1.3	2	1.1	0.3		0.124
M12649/M12610	M12649/M12610	25.4	27.5	44	46	2	4	1	1.3	2.2	1.19	0.28		0.169
LM12749/LM12710		26	27.5	39.5	42	3	4	1	1.3	2	1.1	0.31		0.115
LM12749/LM12711	LM12749/LM12711	26	27.5	40	42.5	3	4	1	1.3	2	1.11	0.3		0.12
LM12749/LM12710 (Cone)	LM12749/LM12710 (Cone)	26	28	39.5	41.5	2	4	1	1.3	2	1.11	0.3		0.115
LR306/33.02														0.0712
07100/07196	07100/07197	29.5	30.5	44.5	47	3	5	1	1	1.5	0.82	0.4		0.119
L44643/L44610	L44643/L44610	29.5	31.5	44.5	47	3	5	1	1.3	1.6	0.88	0.37		0.127
L44649/L44610	L44649/L44610	31	37.5	44.5	47	3	5	3	1.3	1.6	0.88	0.37		0.12
L45449/L45410	L45449/L45410	33	39.5	44.5	48	3	5	3	1.3	1.6	0.89	0.37		0.113
LR306/33.02/YB	(Cone)													0.248
M86649/M86610		38.2	41	54	61	3	5	3	1.3	1.1	0.6	0.55		0.331
LM67048/LM67010	LM67048/LM67010	36	42.5	52	56	3	5	3	1.3	1.5	0.8	0.41		0.18
LM67048/LM67010		36	42.5	52	56	4	5	3	3	1.5	0.8	0.41		0.18
15123/15245		36	42.5	52	56	4	5	4	4	1.7	0.94	0.35		0.244
02475/02420		38.5	39	59	63	6	3	4	1.5	1.4	0.42	0.382		0.382
14125A/14276		37.5	44	60	63	3	5	4	1.3	1.6	0.86	0.38		0.353
LM48548/LM48510	LM48548/LM48510	40	46	58	61	3	5	3	1.3	1.6	0.88	0.38		0.252
3379/3320	3379/3320	41.5	48	70	74.8	3	5	3	2.5	2.2	1.21	0.27		0.742
L68149/L68110		39	45.5	52	56	3	4	3	3	1.4	0.79	0.42		0.169
L68149/L68111		39	45.5	53	56	3	4	3	3	1.4	0.79	0.42		0.177
JL69349/JL69310	JL69349/JL69310	41	47	56	60	4	6	3	1.3	1.4	0.79	0.42		0.186
2788R/2720	2788R/2720	43	50	65	72	4	6	3	2.5	2.0	1.12	0.3		0.501
M201047/M201011	M201047/M201011	44	51	66	70	4	6	1	2.1	1.9	1.02	0.32		0.432

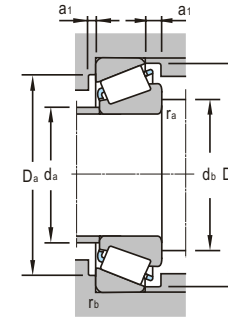
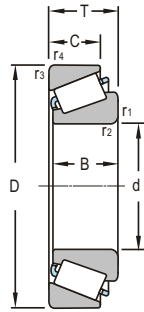

d 41.275~69.85mm

Boundary Dimensions								Basic Load Ratings		Limiting Speeds	
d	D	T	B	C	r _{1,2min}	r _{3,4min}		Dynamic C	Static C ₀	Grease	Oil
mm								kN		r/min	
41.275	73.43	19.56	19.81	14.73	3.5	0.8		55	73.9	4800	6300
	82.55	26.54	25.65	20.19	3.5	3.3		76.3	105		
	88.9	30.16	29.37	23.02	3.5	3.3		95.2	127	4300	5600
44.45	82.93	23.81	25.4	19.05	3.5	0.8		80.9	106	4500	6000
45.23	79.99	19.84	20.64	15.08	2	1.3		55.1	70.8	4800	6300
45.242	73.43	19.56	19.81	15.75	3.5	0.8		53.9	69.5	4800	6300
	77.79	21.43	19.84	16.67	3.5	0.8		52.2	73.7	8110	10140
45.618	82.93	23.81	25.4	19.05	3.5	0.8		80.9	106	4500	6000
	82.93	26.99	25.4	22.23	3.5	2.3		80.9	106	4500	6000
50	82	21.5	21.5	17	3	0.6		66.9	94.1	4840	6060
50.8	82.55	21.59	22.23	16.51	3.5	1.3		60.8	94.1	4790	5990
52.388	92.08	24.61	25.4	19.85	3.5	0.8		82	108	4000	5300
54.488	104.78	36.51	36.512	28.58	2	3.3		139	192		
54.5	104.78	36.51	36.512	28.58	2	3.3		139	192		
55	90	23	26	18.5	3.5	0.5		84	110	3800	5000
55.562	97.63	24.61	24.608	19.45	3.5	0.8		89	129	4160	5200
	101.6	25.4	25.4	19.85	5	3.3		85.8	125	3600	4800
63.5	107.95	25.4	25.4	19.05	1.5	3.3		90	138		
	122.24	38.1	38.354	29.72	7	1.5		172	245	3400	4300
	122.24	38.1	38.354	29.72	7	3.3		172	245	3400	4300
66.675	107.95	25.4	25.4	19.05	3.5	0.8		85.8	125	3600	4800
	122.24	38.1	38.354	29.72	3.5	1.5		193	255	3400	4200
	122.24	38.1	38.354	29.72	3.5	3.3		193	255	3400	4200
68.262	161.93	49.21	46.038	31.75	3.5	3.3		256	304	2690	3360
69.85	146.05	41.28	39.688	25.4	3.6	3.4		192	239	2880	3610

Bearing Designations		Mounting Dimensions								Calculation Factors				Mass
Present	Original	d _{amax}	d _{bmax}	D _{amin}	D _{amin}	a ₁	a ₂	r _{amax}	r _{bmax}	Y ₁	Y ₂	Y ₀	e	kg
		mm												
LM501349/LM501310	LM501349/LM501310	46.5	53	67	70	3.5	6	4	0.8	1.5	0.8	0.4		0.336
M802048/M802011F		51	57	70	79	3	6	4	3.3	1.1		0.55		0.617
FHM803146/FHM803110	FHM803146/FHM803110	53	53.5	70	84	4	7	3	2.5	1.1	0.6	0.54		0.882
25580/25520	25580/25520	50	56	72	78	4	6	3	0.8	1.85	1.02	0.32		0.57
17887/17831	17887/17831	50	56	72	78	4	6	2	1.3	1.64	0.9	0.37		0.402
LM102949/LM102910	LM102949/LM102910	50	57	68	70	3	5	3	0.8	1.97	1.08	0.31		0.3
LM603049/LM603012		50	57	70	74	3.5	5	4	0.8	1.41	0.77	0.43		0.385
25590/25520	25590/25520	50	56	72	78	4	6	3	0.8	1.8	1	0.33		0.554
25590/25523	25590/25524	50	56	72	78	4	6	3	2.1	1.8	1	0.33		0.603
JLM104948/JLM104910		55	60	76	78	4	6	3	2.5	1.97	1.08	0.31		0.429
LM104949/LM104911		55	62	75	78	4	6	4	1.3	1.97	1.08	0.31		0.426
28584/28521	28584/28521	59	69	83	87	4	7	2.5	0.8	1.59	0.87	0.38		0.695
HM807048/HM807010		63	73	89	100	4	7	3.5	3.3	1.23		0.49		1.38
LY-305														1.38
JLM506848E/JLM506810	JLM506848E/JLM506810	61	69	78	87	7	8	2.5	0.5	1.49	0.82	0.4		0.586
28880/28622		62	68	88	92	4	5	3.5	0.8	1.49	0.82	0.4		0.754
28985/28820	28985/28820	68	80	88	97	5	9	2.5	2.5	1.41	0.78	0.43		0.798
29580/29520														0.915
HM212047/HM212010	HM212047/HM212010	73	80	110	116	4	6	6	1.5	1.78	0.98	0.34		1.94
HM212047/HM212011	HM212047/HM212011	73	80	110	116	4	6	6	2.5	1.78	0.98	0.34		1.93
29580/29522	H29580/29522	75	87	94	102.5	4	10	2.5	0.8	1.31	0.72	0.46		0.854
HM212049/HM212010	HM212049/HM212010	75.5	82	110	116	4	6	2.5	1.5	1.78	0.98	0.34		1.85
HM212049/HM212011	HM212049/HM212011	75.5	82	110	116	4	6	2.5	2.5	1.78	0.98	0.34		1.85
92789220		90.4	97	138	153	4.5	12	3.5	3	0.85	0.46	0.71		4.46
HB13048/HB13810		82	95	124	138	5.5	11	3.5	3	0.77	0.42	0.78		2.92

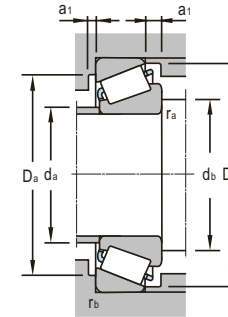
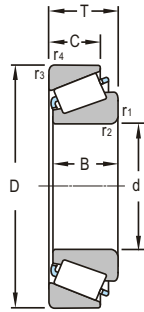

d 71.438~142.875mm

Boundary Dimensions							Basic Load Ratings		Limiting Speeds	
d	D	T	B	C	r _{1,2min}	r _{3,4min}	Dynamic C	Static C ₀	Grease	Oil
mm							kN		r/min	
71.438	127		36.51	26.998	3.5	1.5	167	237		
76.2	171.45		55.1	42.86	6.4	3.3	330	451		
84.976	125.41	25.4	25.4	19.845	5	1.5	110	183	2970	3710
88.9	152.4	39.69	39.69	30.162	6	3.51	229	362	2550	3190
89.975	146.98	40	40	32.5	7	3.5	229	355	2200	3200
95.25	152.4	39.69	36.32	30.162	5	3.3	185.3	289.7	2480	3100
99.974	156.98	42	42	34	8	3.5	243	391	2380	2970
99.975	212.73	66.68	66.68	53.975	3.5	3.3	556	783	1900	2380
101.6	136.53		21.44	16.67	1.5	1.5	91.8	166		
	180.98	47.63	48.01	38.1	3.5	3.3	288	436		
	250.83		73.02	50.8	6.4	6.4	609	793		
104.775	180.98	47.63	48.01	38.1	7	3.3	258	375	2000	2600
107.95	161.93	34.93	34.93	26.988	3.5	3.3	164	280	2000	2800
109.538	158.75	23.02	21.44	15.875	5	3.3	103	167		
114.3	152.4	21.43	21.43	16.67	1.5	1.5	89	178	2000	2800
	212.73	66.68	66.68	53.975	7	3.3	570	810	1700	2200
	212.73		66.68	53.975	7	3.3	556	783		
117.475	180.98	34.93	31.75	25.4	3.5	3.3	174	254	1800	2400
120	174.63	35.72	36.51	27.783	3.5	1.5	212	385	1900	2600
120.65	273.05		82.55	53.975	6.4	6.4	739	1000		
123.825	182.56	39.69	38.1	33.338	3.5	3.3	228	445	1800	2400
130.175	203.2	46.04	46.04	38.1	3.5	3.3	315	560	1700	2200
142.875	200.03	41.28	39.68	34.13	3.5	3.3	242	500	1710	2130

Bearing Designations		Mounting Dimensions								Calculation Factors				Mass
Present	Original	d _{amax}	d _{bmax}	D _{amin}	D _{amin}	a ₁	a ₂	r _{amax}	r _{bmax}	Y ₁	Y ₂	Y ₀	e	kg
		mm												
HM813849/HM813811		82	91	111	121	8	4	3.5	1.5	1.65	0.9	0.36		1.84
6575S/6533BS		96	109	140	153					1.51	0.83	0.4		5.39
27695/27620		91	100	115	120	5	6	5	1.5	1.44	0.79	0.42		1
HM516445/HM516410		102	108.5	135	139	6	9.5	0.5	0.5	1.49	0.82	0.4		2.9
HM216246/HM216210	HM216246/HM216210	95	110.7	132	140	5	7	6	2.5	1.8	1	0.33		2.52
594A/592A		104	113	135	144	4	9.5	3.3	5	1.36	0.75	0.44		2.55
HM220149/HM220110		109	123	142	151	5.5	9	18	18	1.9	0.99	0.33		2.92
HH224334/HH224310		120	124	192	202	7	12	3	3	1.84	0.99	0.33		11.3
L42046-338/L420410-338		107	109	128	132	6	3.5	1.5	1.5	1.63	0.89	0.37		0.841
780/772		113	119	161	168	5	9.5	3.3	3.5	1.56		0.39		5.02
HH923649S/HH923610S		131	149	207	229	15.5	6.5	6.4	6.4	0.86	0.47	0.7		17.9
787/772		116	129	161	168	5	9.5	7	3.3	1.56	0.86	0.39		4.66
48190/48120		116	122	146	156	3.5	8	3.5	3.3	1.2	0.65	0.51		2.42
37431A/37625		116	126	143	152	3.5	7	5	3.3	0.99		0.61		1.31
L623149/L623110		120	123	143	147	3.5	5.5	1.5	1.5	1.5	0.8	0.41		1.05
HH224346/HH224310		131	143	192	202	7	12	7	3.3	1.84	1	0.33		10
HH224346/HH224310J		134	133.5	189.6	201.3	7	12.7	7.1	3.2	1.84	1.01	0.33		9.97
68462/68712		125	132	163	172	2	7.5	3.5	3.3	1.21	0.66	0.5		2.78
M224748/M224710		129	135	163	168			3.5	1.5	1.8	0.99	0.33		2.78
HH926749/HH926710J		147	168	230	253	19.5	59	6.4	6.4	0.95	0.51	0.63		22.2
48286/48220		133	139	168	176	4.5	7	3.5	3.3	1.97	1.1	0.31		3.51
67389/67320		141	146	183	191			3.5	3.3	1.7	0.96	0.34		5.57
48685/48620		151	158	185	193	3.5	7	3.5	3.3	1.78	0.97	0.34		3.84

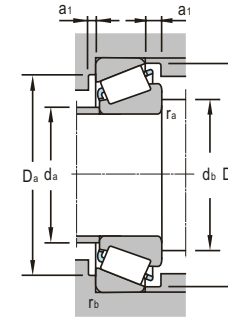
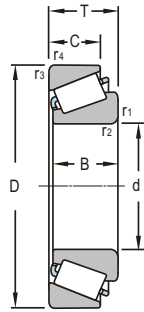

d 146.05~762mm

Boundary Dimensions							Basic Load Ratings		Limiting Speeds	
d	D	T	B	C	r _{1,2min}	r _{3,4min}	Dynamic C	Static C ₀	Grease	Oil
mm							kN		r/min	
146.05	254	66.675	66.68	47.63	7	3.3	530	867		
152.4	254	66.675	66.68	47.63	7	3.3	515	830	1300	1800
165.1	247.65	47.625	47.63	38.1	3.5	3.3	345	705	1300	1700
174.63	247.65	47.625	47.63	38.1	3.5	3.3	345	705	1300	1700
180	250	47	45	37	3	2.5	338	682	1300	1630
190	260	46	44	36.5	3	2.5	370	730	1100	1600
196.85	254		27.78	21.44	2	1.5	195	400		
	257.18		39.69	30.16	3.5	3.3	277	617		
206.38	282.58	46.038	46.04	36.51	3.5	3.3	365	800	1000	1400
209.55	317.5		63.5	46.038	4.3	3.3	6.9	1090		
254	358.775	71.438	71.438	53.975	3.5	3.3	694	1550	830	1040
304.8	444.5	63.5	61.912	39.688	6	1.1	685	1140	510	640
	546.1	171.053	171.053	140.097	6	6	2800	5800	490	600
381	590.55		114.3	88.9	6.4	6.4	2240	4310		
393.7	546.1	76.2	61.12	55.562	6	6	860	1343	500	630
415.925	590.55		114.3	88.9	6.4	6.4	2000	4330		
431.8	571.5	74.612	52.388	74.612	3.3	3.3	1080	2470	380	480
498.475	634.873		80.962	63.5	6.4	3.3	1320	3350		
609.6	787.4	93.662	93.662	69.85	6	6	2010	5060	340	450
685.8	876.3	93.662	92.075	69.85	6.4	6.4	1980	5150	300	400
759.925	889	88.9	88.9	72	3.3	3.3	1910	6130		
762	889	88.9	88.9	72	3.3	3.3	1910	6130		

Bearing Designations		Mounting Dimensions							Calculation Factors				Mass	
Present	Original	d _{amax}	d _{bmax}	D _{amin}	D _{amin}	a ₁	a ₂	r _{amax}	r _{bmax}	Y ₁	Y ₂	Y ₀	e	kg
		mm												
9957599100		162	175	227	238	8	13.5	7	3.3	1.47		0.41		13.2
9960099100		170	181	227	238	8	13.5	7	3.3	1.47	0.81	0.41		12.29
67780/67720		179	185	229	240	5	8	3.5	3.3	1.36	0.75	0.44		8.16
67787/67720		185	192	229	240	5	8	3.5	3.3	1.4	0.75	0.44		7.21
JM736149/JM736110		190	196	232	243	5.5	10	3	2.5	1.25	0.69	0.48		6.72
JM738249/JM738210		200	206	242	252	5.5	9.5	3	2.5	1.3	0.69	0.48		6.93
L54049/L54010		205	207	243	247	7	3.5	2	1.5	1.51	0.83	0.4		3.43
LM739749/LM739710		206	213	239	251	9	4.5	3.5	3	1.34	0.74	0.45		5.19
67985/67920		219	224	260	275	5	8	3.5	3.3	1.2	0.65	0.51		8.48
93825S/9312SS		227	233	286	300	12.5	8.5	6.4	6.4	1.15	0.63	0.52		16.9
M249749/M249710		270	274	335	343	7.5	13.5	3.5	3.3	1.8	1	0.33		21.7
EE291201/291749	3-736	340	370	403	422	8	28	1.5	1	1.6	0.87	0.38		25.1
306/304.8	7961	355	400	500	515	8	28	5	5	1.8	1	0.34		175
M268730-2/10-2		459.2	400.8	545	560	9	25.4	6.4	6.4	1.8	0.99	0.33		111
EE234154/234215	7979	416	437	508	532	18	25	6	5	1.2	0.7	0.48		44.8
M268749-3/10-3		459.2	436.7	545	560	9	25.4	6.4	6.4	1.8	0.99	0.33		95.8
"LM669448J/LM669410J"		453	457	537	549	5	16	3.3	3.3	1.1	0.6	0.55		48.2
EE243196/243250		516	522	603	609	15	8.5	6.4	3.3	1.75	0.96	0.34		60.2
EE649240/649310	3-734	655	690	725	760	10	25	6	5	1.6	0.9	0.37		110
EE655270/655345	EE655270/655345	714	723	831	843	13	25	5	5	1.4	0.8	0.42		133
L183448/L183410		780	783	864	873	12.5	19	5	5	1.97		0.31		89.9
L183449/L183410		780	783	864	872	12.5	19	5	5	1.97		0.31		88.2

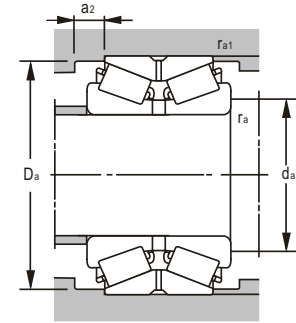
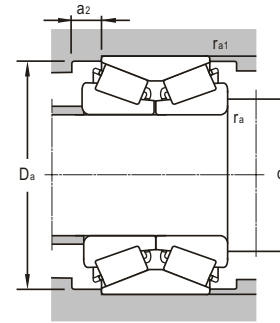
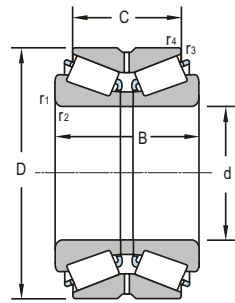
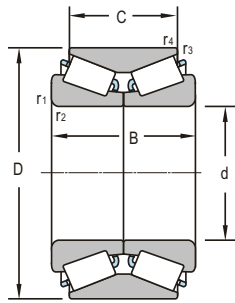

d 30~100mm

Boundary Dimensions						Basic Load Ratings	
d	D	B	C	r _{1,2min}	r _{3,4min}	Dynamic C	Static C ₀
mm						kN	
30	60.03	37	37	2.5	0.4	61.5	87.7
34	64	37	37	2.5	1	60	82
35	64	37	37	2.5	1	60	82
	80	57	45	2	0.5		
42	76	39	39	2	1.5	67.6	105.5
49	84	48	48	2.8	0.5	97.3	171
	84	48	48	2.8	0.5	94.6	165
50	84	54	54	5.5	1.5	106	236
	100	50	50	5.5	1.5	137	195
	100	79	54	2	0.8		
	100	79	54	2	0.8		
55	90	52	43	3.5	0.2	142	220
	100	60	48.5	2	0.6	192	281
65	120	73	61.5	2	0.6	279	424
70	110	38	28	1	0.5	104	156
75	130	75	62	2	0.3	294	466
	130	75	62	2.5	0.5		
78	130	90		1.5	0.6	244	443
80	140	78	63.5	2.5	0.6	339	526
85	150	86	69	2.5	0.6	406	647
90	160	94	77	2.5	0.6	405	535
95	145	76	64	2.5	0.6	385	580
	170	100	100	3	1	543	897
100	180	100	84	1.5	0.6	603	1010
	180	107	87	3	1	603	1010
	180	112	92	3	1	603	1010

Bearing Designations		Mounting Dimensions					Calculation Factors				Mass
Present	Original	d _{amax}	D _{amin}	a ₂	r _{amax}	r _{omax}	Y ₁	Y ₂	Y ₀	e	kg
		mm									
350606-2LS		42	56	0	2	2	1.5	2.19	1.4	0.46	0.491
3506/34X3TN1-2RS		46	61.5	0	2	2	1.5	2.19	1.4	0.46	0.483
350607X3TN1-2RS		47	61.5	0	2	2	1.5	2.19	1.4	0.46	0.467
	57707	60	76.5	7	2	2	1.21	1.84	1.21	0.55	1.22
3506/42X3TN1-2RS		58	71	0	2	2	1.21	1.84	1.21	0.55	0.644
3506/49-2LS		63	79	0	2.5	2.5	1.5	2.19	1.4	0.46	1.13
3506/49TN1-2LS		63	79	0	2.5	2.5	1.5	2.19	1.4	0.46	1.1
350610X3TN1-2RS		65	79	0	4	4	1.5	2.19	1.4	0.46	1.19
	LY-3021	59	90	0	1.5	1.5	1.6	2.4	1.6	0.42	1.62
	797710	62	88	13	2	2	1.6	2.4	1.6	0.42	2.45
	797710 K	62	88	13	2	2	1.6	2.4	1.6	0.42	2.44
32011X2/DF	3-762	69	87	6	2.5	0.2	1.7	2.5	1.6	0.4	1.23
352211		64	96	6	2	0.6	1.7	2.5	1.6	0.4	1.83
352213		75	116	6	2	2	1.63	2.48	1.63	0.4	3.35
350014 X2	97814	78	104	7	1	0.5	1.5	2.2	1.4	0.46	1.06
352215		84	125	6.5	2	0.3	1.6	2.3	1.5	0.43	3.62
	97515	87	125	6	2	0.5	1.6	2.3	1.5	0.43	3.62
DU7813090		94	125				1.59	2.37	1.56	0.42	4.58
352216		90	135	7.5	2	0.6	1.57	2.39	1.57	0.42	4.48
352217		95	143	8.5	2	0.6	1.61	2.39	1.57	0.42	5.85
352218		102	153	8.5	2	0.6	1.6	2.4	1.6	0.42	7.21
	97518E										
	697819K										4.56
352219		108	165	10	2.5	1	1.6	2.4	0.42	1.6	9.16
	B697820L	114	170	10	2	0.8	1.61	2.39	1.57	0.42	9.27
352220		114	171	10	2	0.8	1.6	2.4	1.6	0.42	10.9
352220 X2		114	175	14	3	1	1.86	2.83	1.86	0.36	11

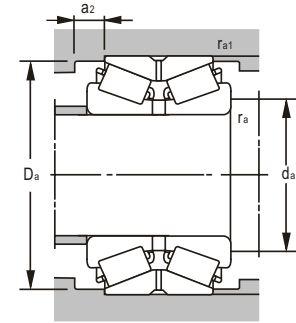
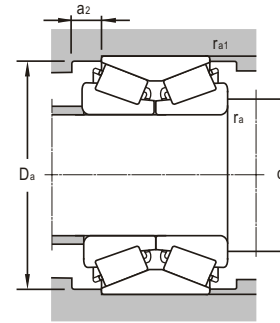
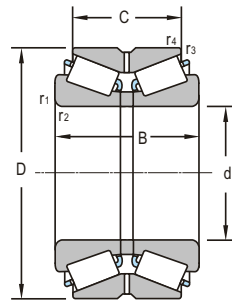
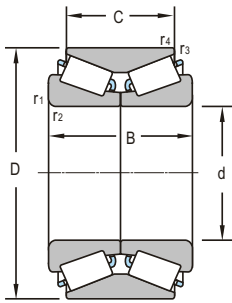

d 100~200mm

Boundary Dimensions						Basic Load Ratings	
d	D	B	C	r _{1,2min}	r _{3,4min}	Dynamic C	Static C ₀
mm						kN	
100	190	125	100	3	1.3	651	1200
110	180	95	76	2	0.6	473	839
	200	121	101	3	1	763	1310
	200	121	101	3	1.2	764	1308
	200	124	102	3	1	763	1310
120	180	86	86	2.5	0.5	394	788
	200	110	90	2.5	0.6	663	900
	200	110	90	2	0.6	663	900
	215	58	109	3	1	858	1520
	215	132	109	3	1	843	1480
130	200	95	75	2.5	0.6	425	958
	200	110.4	110.4	2.5	0.5	542	1060
	210	110	90	2	0.6	618	1150
	230	149	120	4	1	916	1680
	230	222	150	3	1	842	957
140	210	95	75	2.5	0.6	498	924
	210	100	100	2.5	0.5	538	1066
150	320			5	1.5	1370	2140
160	240	115	90	3	1	670	1062
	240	116		3	1	719	1470
	270	140	120	2.5	1	947	2020
	270	150	120	2.5	1	947	2020
170	260	120	95	3	1	811	1630
	260	128	100	3	1	833	1458
180	250	102	80	2.5	0.6	519	1370
	250	95	74	2.5	0.6	504	1263
	280	134	108	3	1.2	972	1930
	280	150	150	3	0.9	1048	2140
	300	164	134	3	1	1260	2510
190	260	95	75	2.5	0.6	574	1400
	320	170	130	3	1	1410	2720
200	280	110	85	3	1	615	1670
	280	116	92	3	1	758	1700

Bearing Designations		Mounting Dimensions					Calculation Factors				Mass
Present	Original	d _{amax}	D _{amin}	a ₂	r _{amax}	r _{amax}	Y ₁	Y ₂	Y ₀	e	kg
		mm									
350620D1		118	175	14	3	2	1.86	2.83	1.86	0.36	15.4
352122	2097722	120	175	10	2	0.6	2.32	3.53	2.32	0.28	8.63
		124	193	11	2.5	0.8	1.57	2.39	1.57	0.42	15.7
	LY-3028	124	190	10	2.5	0.8	1.61	2.39	1.57	0.42	16
		124	193	11	2.5	1	1.57	2.39	1.57	0.42	16
352222X2											
32024T86/DB		130	173	11	2	0.5	1.8	2.7	0.37	1.8	6.74
352124	2097724	130	194	12	2	0.6	2.2	3.3	2.2	0.3	12
	2697724	130	187	12	2	2	2.7	4.11	2.7	0.24	12
352224YA		132	206		2.5	1	1.5	2.3	1.5	0.44	19.5
352224		134	205	13	2.5	1	1.52	2.32	1.52	0.44	19.5
352026 X2	2097126	142	188		2	0.6	1.88	2.87	1.88	0.35	10.1
32023/DB		144	194	11	2	0.5	1.6	2.3	0.43	1.6	11.5
352126	2097726	140	198	8	2	0.6	1.8	2.7	1.8	0.37	13.5
352226 X2		148	215	15	3	1	2.6	3.8	2.5	0.26	24.6
350626SC	197726	141	203	12	2.5	1	2.6	3.8	2.5	0.26	30.2
352028 RX2	2697128	147	200	12	2	0.6	1.8	2.7	1.8	0.37	12.1
32028T100/DB		153	202	11	2	0.5	1.5	2.2	0.46	1.4	11.2
351330X2		182	308				1.87	2.88	1.85	0.36	55
352032 RX2	2697132	168	228	14	2.5	1	1.8	2.7	1.8	0.37	14.9
352032		178	220				1.45	2.16	1.42	0.46	16.5
352132 X2		172	252	12	2	1	2.1	3.2	2.1	0.32	31
352132	2097732	172	252	16	2	1	2.1	3.2	2.1	0.32	31.6
352034 X2	2097134	184	250	13	3	1	1.48	2.26	1.48	0.44	21.2
352034YA	2097134K	183	248	14	2.5	1	2.2	3.2	2.1	0.31	21
352936		192	242	11	2	0.6	1.37	2.09	1.37	0.48	14.2
352936 X2	2097936	192	239	11	2	0.6	1.76	2.68	1.76	0.37	13.1
352036 X2	2097136	194	263	13	2.5	1	2.32	3.53	2.32	0.28	28
32036T150X/DB		199	268	16	2.5	0.9	2.4	3.6	0.28	2.3	30.7
352136	2097736	194	279	14	2.5	1	2.46	3.93	2.58	0.26	39.3
352938X2D1		200	253	9.5	2	0.6	1.76	2.62	1.72	0.38	14
352138	2097738	204	298	20	2.5	1	2.3	3.5	2.3	0.28	50.4
352940 X2	2097940	214	266	13	2.5	1	1.66	2.53	1.66	0.39	19.7
352940 X2/YA	2097940EK	214	273	14	2.5	1	1.8	2.6	1.7	0.39	22

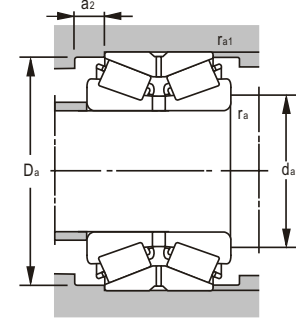
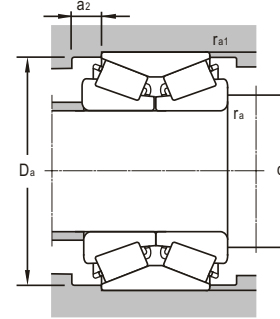
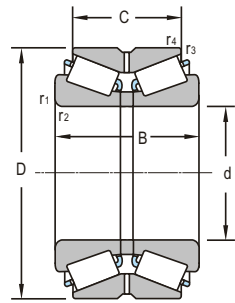
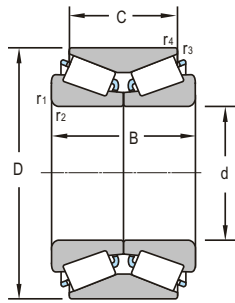

d 200~340mm

Boundary Dimensions						Basic Load Ratings	
d	D	B	C	r _{1,2min}	r _{3,4min}	Dynamic C	Static C ₀
mm						kN	
200	310	152	120	3	1	1210	2480
205	320	150	110	5	2	1080	2180
220	300	110	88	3	1	780	1870
	340	113	90	4	1.5	942	1720
	340	165	130	4	1	1370	2760
	340	130		4	1	1410	2860
	370	195	150	4	1.1	1850	3670
240	320	110	90	3	1	811	1950
	360	165	128	4	1	1340	3120
	390	185		4	1.5	2440	5220
	400	160	128	5	1.5	1570	3370
	440	294	240	4	1	3349	5508
260	360	134	108	3	1	1263	2430
	360	134	108	3	0.9	1263	2430
	400	185	146	3.5	1.5	1955	2600
	400			5	1.1	1890	4250
	400	190	190	5	1.1	1890	4250
	430	180	130	7.5	1.5	2737	3016
	440	225	180	4	1.1	2630	5190
280	380	134	108	2.5	1	1328	1885
	420	133	106	4	2	1270	1936
	420	186	146	5	1.1	1570	4000
300	420	160	128	4	1	1700	4270
	420	175	136	5	1	1800	2629
	440	140	100	5	1	2560	4440
	460	210	165	5	1.1	2278	4148
	500	205	152	5	1.5	2618	4165
320	440	160	128	4	1	1650	3900
	480	210	160	5	1.1	2540	5750
340	460	160	128	4	1	1575	4050
	520	180	135	5	1.5	2060	4100
	580	242	170	5	1.5	3100	6000

Bearing Designations		Mounting Dimensions					Calculation Factors				Mass
Present	Original	d _{amax}	D _{amin}	a ₂	γ _{amax}	γ _{max}	Y ₁	Y ₂	Y ₀	e	kg
		mm									
352040 X2		212	297	10.5	2	1	1.7	2.6	1.7	0.39	39.6
350641D1		216	314	12	2.5	2	1.7	2.6	1.7	0.39	40.2
352944 X2		231	292	11.5	2.5	1	1.6	2.4	1.6	0.43	21.2
351044		234	319	11.5	3	1.5	1.8	2.69	1.76	0.37	33.1
352044 X2		238	324	19	3	1	2	2.9	2	0.34	49.4
352044X2A/HCP6		234	331				1.9	2.9	1.9	0.35	49.8
352144		238	341	15	3	1.5	1.83	2.72	1.79	0.37	78.2
352948 X2		254	314	12	2.5	2.5	1.4	2.19	1.4	0.46	22.6
352048 X2		258	340	20	3	3	1.9	2.89	1.9	0.35	55.2
355148X3		276	370				2.05	3.05	2	0.33	101
32248 X2/DB	240 KBE 031+L 3-745	264	380	18	4	1.5	1.69	2.57	1.69	0.39	75.2
		252	427	2.6	3	1	1.6	2.3	7.5	0.43	174
352952 X2	2097952	274	350	16	2.5	1	1.8	2.7	1.8	0.37	36.8
352952 X2/YA	2097952K	274	350	16	2.5	1	1.8	2.7	1.8	0.37	36.8
352052 X2	2097152	277	380	22	4	1	2.3	3.3	2.2	0.3	76.8
352052X2A/HCP6		318	382				1.5	2.24	1.47	0.43	84
352052/W33		277	380	22	4	1	1.6	2.3	0.43	1.6	82
350652	97752	285	398	25	6	1.5	2	2.9	2	0.34	93.4
352152		278	418	25	3	3	1.76	2.68	1.76	0.37	131
352956 X2	2097956	294	371	16	2.5	1	2.3	3.4	2.3	0.29	41.3
351056 X2	97156	302	397	14	3	2	2.2	3.3	2.2	0.3	58.1
352056 X2		302	400	20	4	4	1.8	2.7	1.8	0.37	84.6
352960 X2	2097960	317	408	18	3	1	2.4	3.6	2.3	0.28	63
352960/YB2	97760	315	405	14	4	1	1.9	2.8	1.9	0.36	65.6
350660 D	37860	327	420	22	4	1	1.5	2.3	1.5	0.44	58.42
352060 X2	2097160	320	445	24	4	1	2.2	3.2	2.1	0.31	117
351160	1097760	327	470	28	4	1.5	2.1	3.2	2.1	0.32	143
352964 X2	2097964	335	427	18	3	1	2.3	3.3	2.2	0.3	67
352064 X2	2097164	345	456	25	4	1	1.6	2.4	1.6	0.42	122
352968 X2	2097968	355	448	18	3	1	2.2	3.2	2.1	0.31	71
351068	97168	360	501	27	4	1.5	2.3	3.4	2.3	0.29	119
351168	1097768	368	555	38	4	1.5	1.6	2.4	1.6	0.42	214

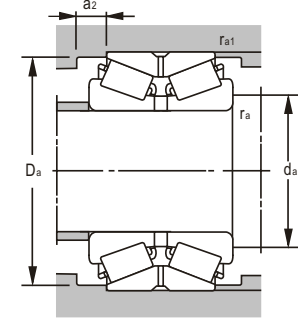
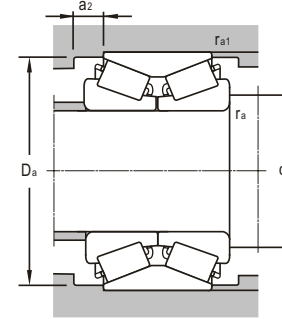
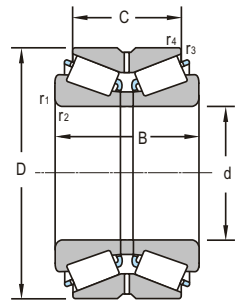
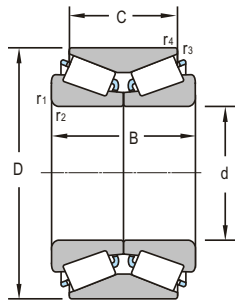

d 350--530mm

Boundary Dimensions						Basic Load Ratings	
d	D	B	C	r _{1,2min}	r _{3,4min}	Dynamic C	Static C ₀
mm						kN	
350	590	200	140	9.5	1.5	1992	3367
360	480	160	128	4	1	1640	2847
530	155	110	5	1.5	1344	2800	
530	155	110	5	1.5	1344	2800	
540	185	140	5	1.5	2800	6300	
600	242	170	5	1.5	3410	6800	
380	520	145	105	4	1.1	1660	3800
560	190	140	5	1.5	2880	6300	
620	242	170	5	1.5	3410	6850	
400	540	150	105	4	1.1	1650	3550
590	185	123	5	2	1500	3080	
600	206	150	5	1.5	2890	6300	
420	560	145	105	4	1.1	1880	4450
620	190	125	5	1	1470	2490	
620	206	150	5	1.5	2670	5880	
700	275	200	6	2.5	4430	9150	
440	600	170	125	4	1.1	1390	2560
650	212	152	6	2.5	4950	10400	
720	190	226	6	2.5	4580	9430	
720	283	226	6	3	5300	11700	
460	620	174	130	4	1.1	1410	2630
680	175	230	6	2.5	3024	6732	
480	650	180	130	5	1.5	2150	5150
700	240	180	6	2.5	2928	5316	
490	640	180	144	7.5	3	1716	3549
500	670	180	130	5	1.5	1884	3740
720	236	180	6	2.5	3580	8150	
520	740	190	120	2.5	2.5	2158	3913
530	710	190	136	5	1.5	2670	6300
780	231	231	6	3	4550	10100	

Bearing Designations		Mounting Dimensions					Calculation Factors				Mass
Present	Original	d _{amax}	D _{amin}	a ₂	r _{amax}	r _{amax}	Y ₁	Y ₂	Y ₀	e	kg
		mm									
350670	97770	368	566	32	8	1.5	1.6	2.4	1.6	0.42	212
352972 X2	2097972	376	468	18	3	1	2.1	3.1	2	0.33	74.3
350672	97772	378	510	25	4	1.5	1.7	2.5	1.6	0.4	107
350672 D1	37772	378	510	25	4	1.5	1.7	2.5	1.6	0.4	109
351072	97172	380	522	27	4	1.5	2.3	3.3	2.2	0.3	127
351172	1097772	390	575	38	4	1.5	1.5	2.3	1.5	0.44	235
351976	1097976	402	505	22	3	1	1.6	2.3	1.6	0.43	80.3
351076	97176	406	542	27	4	1.5	2.2	3.2	2.1	0.31	146
351176	1097776	405	598	38	4	1.5	1.5	3.2	1.4	0.46	243
351980	1097980	420	525	24	3	1	1.6	2.2	1.5	0.45	86.9
350180 D	37780	420	558	35	4	2	2.2	3.2	2.1	0.31	166
351080	97180	420	580	30	4	1.5	1.7	2.5	1.7	0.4	180
351984	1097984	440	546	24	3	1	2.2	2.3	2.1	0.31	88.7
350184 D	37784	440	598	34	4	1	2.1	3.2	2.1	0.35	171
351084	97184	448	601	30	4	1.5	1.6	2.5	1.6	0.41	187
351184	1097784	460	670	40	5	2	2.1	3.1	2.1	0.32	392
351988	1097988	460	585	24	3	1	1.8	2.6	1.7	0.39	114
351088	97188	469	629	32	5	2	1.6	2.3	1.5	0.43	213
351188		480	700				1.45	2.16	1.42	0.46	404
440KBE03194+L		468	678	28.5	5	2.5	1.68	2.5	1.64	0.4	443
351992	1097992	480	605	24	3	1	1.7	2.5	1.7	0.4	130
351092	97192	489	657	32	5	2	2.2	3.2	2.1	0.31	253
351996	1097996	520	633	27	4	1.5	1.6	2.4	1.6	0.42	151
351096	97196	511	671	32	5	2	2.1	3.1	2.1	0.32	281
350698	97798	514	615	20	6	2.5	1.8	2.7	1.8	0.37	140
3519/500	10979/500	524	650	27	4	1.5	1.5	2.3	1.5	0.44	159
3510/500	971/500	530	682	28	5	2	2	3	2	0.33	289
3506/520	977/520	546	712	37	2	2	1.6	2.4	1.6	0.42	231
3519/530	10979/530	554	683	29	4	1.5	1.6	2.5	1.6	0.41	190
3509/530X1		560	760	24	5	2.5	1.8	2.7	0.37	1.8	355

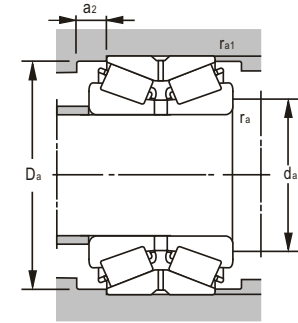
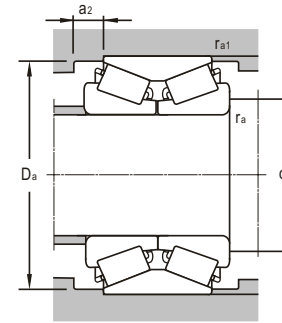
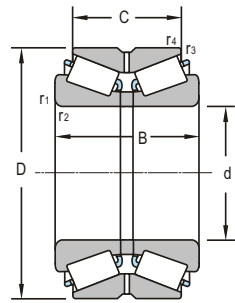
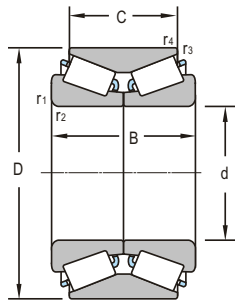

d 560~1600mm

Boundary Dimensions						Basic Load Ratings	
d	D	B	C	r _{1,2min}	r _{3,4min}	Dynamic C	Static C ₀
mm						kN	
560	750	213	156	5	1.5	4081	8880
	820	260	185	6	2.5	4785	9216
600	800	205	156	5	1.5	2772	5832
	800	190	190	5	4	4070	10900
	870	270	198	6	2.5	3828	6912
	870	270	270	6	6	6520	16700
630	850	242	182	6	2.5	4095	8205
670	900	240	180	6	2.5	4260	8970
	980	230	230	10	10	4880	11600
710	950	240	175	6	2.5	4425	9600
	1030	236	208	7.5	4	5310	11520
711.2	914.4	190.5	190.5	6.4	1.5	3560	9430
720	915	190	140	2	5	3451	6681
750	1000	264	194	6	2.5	5370	11175
800	1060	270	204	6	2.5	6086	13464
	1060	270	270	6	1.8	5420	15400
850	1120	268	188	6	2.5	6188	14042
900	1180			6	4	6480	18400
950	1250	300	220	7.5	3	8347	18360
1120	1460	335	250	7.5	3	10319	23290
1370	1605	210	210	7.5	4	5860	20300
1450	1770	290	290	9.5	5	7780	27200
	2050	450	450	9.5	5	18700	60200
	2060	560	360	9.5	4	21420	57970

Bearing Designations		Mounting Dimensions					Calculation Factors				Mass	
Present	Original	d _{amax}	D _{amin}	a ₂	r _{amax}	r _{bmax}	Y ₁	Y ₂	Y ₀	e	kg	
		mm										
3519/560	10979/560	580	725	16	4	1.5	1	1.5	1	0.44	235	
	971/560	594	795	39	5	2	1.7	2.5	1.7	0.4	409	
3519/600	10979/600	625	779	30	4	1.5	2.1	3.1	2	0.33	266	
	3706/600											
	3510/600	971/600	630	845	39	5	2	1.6	2.5	1.6	0.41	500
	3710/600											
3519/630	10979/630	657	829	32	5	2	1.7	2.5	1.7	0.4	368	
3519/670	10979/670	703	875	32	5	2	1.6	2.3	1.5	0.43	416	
	3706/670B/YA6 C3											
3519/710	10979/710	743	925	34	5	2	1.5	2.2	1.4	0.46	444	
	3510/710 X2	977/710	810	995	14	6	3	1.8	2.6	1.7	0.39	651
3506/711.2	977/720	736	887	25	6	1.5	1.76	2.62	0.38	1.72	281	
3506/720	10979/750	756	890	27	2	4	1.9	2.9	1.9	0.35	277	
3519/750	10979/800	783	978	37	5	2	1.7	2.5	1.6	0.4	499	
3519/800		838	1031	37	5	2	1.9	2.9	1.9	0.35	604	
	3519/800-1/P69	10979/850	838	1031	37	5	1.5	1.9	2.9	0.35	1.9	604
3519/850	10979/950	886	1093	42	5	2	1.5	2.2	1.5	0.46	636	
319/900/DB											704	
3519/950	10979/1120	994	1220	42	6	2.5	2	3	2	0.33	909	
3506/1120	978/1600	1170	1427	45	6	2.5	1.9	2.9	1.9	0.35	1344	
3506/1370		1403	1581	35	6	3	1.7	2.5	0.4	1.7	677	
3506/1450		1490	1747	50	8	4	0.78	1.2	0.87	0.76	1348	
3519/1600		1653	2014	50	8	4	1.7	2.5	0.4	1.7	3459	
	3506/1600		1780	2035	52	8	3	0.5	0.8	0.5	1.26	4210

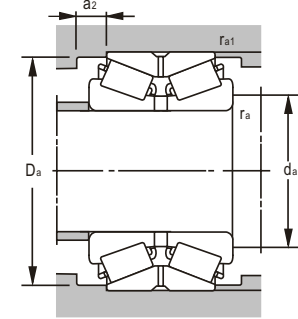
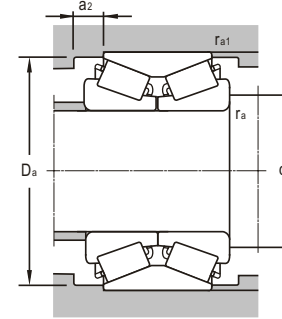
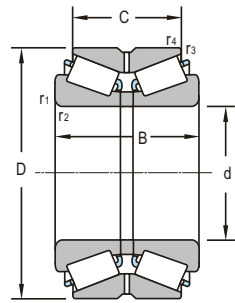
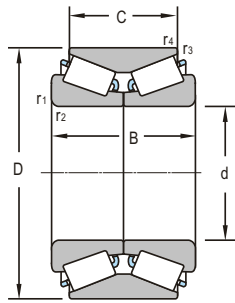

d 88.9~317.5mm

Boundary Dimensions						Basic Load Ratings	
d	D	B	C	r _{1,2min}	r _{3,4min}	Dynamic C	Static C ₀
mm						kN	
88.9	161.925	104.775	85.725	3.5	1.5	467	778
99.995	225	119.962	117	3.3	0.8	605	1060
111.125	190.5	106.362	80.962	3.5	1.5	412	845
114.3	279.4	185.24	127.85	6.4	1.5	1190	1740
127.792	228.6	84.138		3.5	2.3	599	1040
177.8	288.925	142.875	111.125	7	1.5	1070	1220
200.025	317.5	146.05	111.125	4.3	1.5	1180	2450
203.2	276.225	95.25	73.025	3.5	0.8	629	1044
	292.1	109.538	84.138	3.5	0.8	727	1500
	368.3	158.75	152.4	3.2	3.2		
	406.4	196.85	127	4	2	2006	2952
228.6	355.6		111.125	7	1.3	1340	2630
228.6	358.775	152.4	117.475	3.5	1.5	1190	3110
	488.95	345	220	6	1.5	3260	6180
241.3	444.5	209.55	158.75	6.4	1.5	2460	4590
247.65	406.4	247.65	203.2	6.4	1.6	2450	5330
254	347.662	101.6	69.85	3.5	1.5	850	1386
292.1	469.9	200.025	149.225	9.7	1.5	2008	2632
300.038	422.275	174.625	136.525	4	1	1785	2805
304.8	393.7	107.95	82.55	6	1.5	901	1854
	393.7	107.95	82.55	6	1.5	922	2370
	421.75	123.825	92.075	6.4	1.5	1040	2490
	438.048	161.925	123.825	6.4	1	1521	2157
	546.1	376	314	8		5320	6040
317.5	447.675	180.975	146.05	3.5	3.5	2040	5080

Bearing Designations		Mounting Dimensions					Calculation Factors				Mass	
Present	Original	d _{amax}	D _{amin}	a ₂	r _{amax}	r _{amax}	Y ₁	Y ₂	Y ₀	e	kg	
		mm										
NA759/752D		102	150	15	3.5	1.5					8.56	
H221647NA/K426864		114	200	6	0.3	3	2	3	2	0.33	25.1	
71437/71751D		125	180	14	3	2.5	1.6	2.4	1.6	0.42	11.9	
	LY-3018										50.1	
HM926749/HM926710D		156	219			3.5	2.3	0.92	1.36	0.74	18.4	
HM237545/HM237510CD		189	266	18	4	18	2.1	3.2	2.1	0.32	33	
93787/93127D		225	300	20	4	1.5	1.3	1.9	0.52	1.3	39.1	
3506/203.2D/YA3	37941K	214	268	14	2.5	1	2.1	3.1	2	0.32	14.6	
M541349/M541310CD		220	285	25	3.5	0.8	1.7	2.5	1.6	0.4	21.4	
EE420800D/421450	3-758	220	340	6	3.2	3.2	1.7	2.5	1.6	0.4	76.2	
EE114080/114161DC	3-730	228	375	37	4	2	0.9	1.3	0.8	0.78	107	
EE130902/131401CD		238	330	340	6	6.4	1.6	2.04	3.04	2	0.33	49.3
M249732/M249710CD		242	350	14	3.5	1.5	2	3	2	0.33	56.7	
	LY-3020										293	
EE923095/923176D		295	423	26	6.4	1.5	2	3	2	0.34	130	
46T504125GWH											121	
LM249747NW/LM249710D	37951K	270	335	16	2.5	1	2	3	2	0.33	23.9	
EE72215/722186CD		315	450	26	1.5	9.7	1.8	2.7	1.8	0.37	122	
HM256849/HM256810D	97960	320	410	22	4	1	1.9	2.8	1.9	0.35	65.6	
L357049/L357010D	37961K	324	386	20	5	1.5	1.9	2.7	1.8	0.36	30.1	
L357049NW/L357011D/HC3		324	386	20	5	1.5	1.9	2.7	1.8	0.36	30.2	
EE109120/109163D		335	399	15	6	1.5	1.6	2.3	1.6	0.43	43.6	
NA329120/329173D	3-769	340	420	20	5	1	2	3	2	0.34	65.4	
	LY-3009										374	
HM259049/HM25910CD		341	431	18	3	3	2	3	2	0.33	84.6	

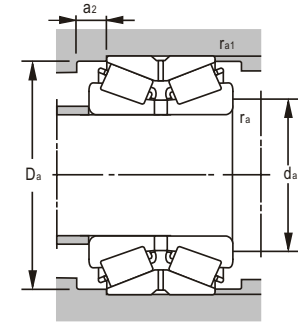
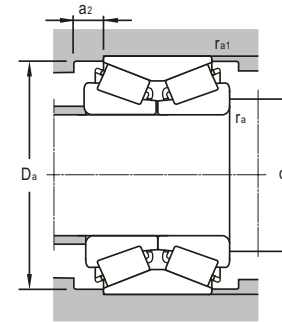
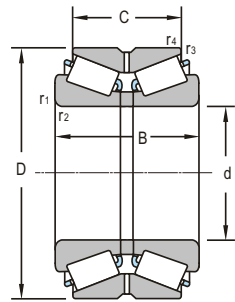
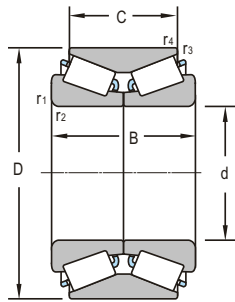

d 368.249 ~ 1041.4mm

Boundary Dimensions						Basic Load Ratings	
d	D	B	C	r _{1,2min}	r _{3,4min}	Dynamic C	Static C ₀
mm						kN	
368.249	523.875	214.312	169.862	6.4	1.5	2570	4650
368.3	523.875	185.738	185.738	3.3	6.4	2450	6730
	596.9	203.2	133.35	9.5	2.5	2490	3650
371.475	501.65	155.575	107.95	6	1	1720	4050
415.925	590.55	244.475	193.675	6.4	1.5	3230	8280
431.8	565.15	100.22	73.5	3.3	1.5	1040	2880
479.425	679.45	276.225	222.25	4.5	1.5	4730	12300
498.475	634.873	177.8	142.875	4.5	1	2550	6990
533.4	812.8		187.325	9.7	3.3	5200	11800
558.8	736.6	225.425	177.8	6	1	4020	11000
	742.95	187.328	138.112	4.5	1.5	2610	5220
600.5	793.75	165.1	115.087	6.4	3.2	1360	3430
1041.4	1235.075	166.7	108	6.4	3.2	1440	4770

Bearing Designations		Mounting Dimensions					Calculation Factors				Mass
Present	Original	d _{max}	D _{min}	a ₂	r _{max}	r _{max}	Y ₁	Y ₂	Y ₀	e	kg
		mm									
HM265049/HM265010D	3-743	386	510	14	5	1	2	3	2	0.33	143
HM265049TDS/HM265010S	97974	394	580	37	8	2	1.4	2.1	1.4	0.48	141
											184
EE231462/231976DC	3-726	394	485	26	5	1	1.5	2.3	1.5	0.44	79
M268749/M268710CD	LY-3019	451	561	25	6	1.5	2	3	2	0.33	200
											60.2
M272749/M272710DC	3-723	503	660	29	4	1.5	1.9	2.9	1.9	0.35	322
EE243196/243251DC	3-725	525	625	16	4	1	2	3	2	0.34	127
EE626210/626321D		585	762		9.7	3.3	1.52		2.26	0.44	466
LM377449/LM377410DC	3-724	587	715	26	5	1	1.9	2.9	1.9	0.35	247
											205
EE843220/843292D	3-737	587	721	24	4	1.5	2	2.6	1.9	0.34	
	LY-3014										197
	LY-3010										320



Taper Roller Bearings

double-row

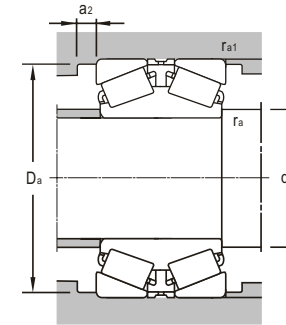
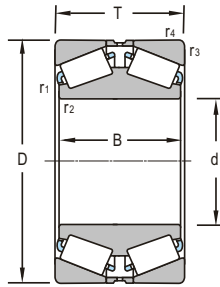

d 70~280mm

Boundary Dimensions						Basic Load Ratings	
<i>d</i>	<i>D</i>	<i>T</i>	<i>B</i>	<i>r</i> _{1,2min}	<i>r</i> _{3,4min}	Dynamic <i>C</i>	Static <i>C</i> ₀
mm						kN	
70	110	56	56	0.8	1.5	169	298
80	110	50	50	0.5	1	125	246
100	215	110	110	2	3	713	1100
	180	74	74	1.5	2.5	473	720
105	160	86	86	2.5	1	411	796
110	240	118	118	1.5	4	662	1040
	170	94	94	2.5	2	456	928
130	280	144	132	1.5	4	1050	1560
150	320	164	150	1.5	4	1250	2210
177.8	288.925	123.825	123.825	1.6	3.2	1091	1870
190	288.5		109	2	2.5	887	1880
	288.5		100	2	2.5	818	1690
200	340	140	140	3	2.5	1470	2860
	380	180	180	4	4	1750	3080
203.2	368.3	158.75	152.4	3.2	3.2	1500	2690
220.662	314.325		115.888	1.5	3.3	1050	2510
254	347.662	101.6	101.6	3.5	3.5	850	1386
	438.15	165.1	165.1	3.2	6.4	1917	3555
	358.775	130.175	130.175	3.5	3.3	1310	3110
260	360	134	134	3	2.5	1020	2581
	420	170	170	5	4	2240	4600
	420	170	170	5	4	2240	4600
266.7	355.6		230.188	1.5	3.3	1840	5260
280	380	134	134	3	2.5	1180	2780
	400	180	180	3	3	1710	4740

Bearing Designations		Mounting Dimensions					Calculation Factors				Mass	
Present	Original	<i>d</i> _{amax}	<i>D</i> _{amin}	<i>a</i> ₂	<i>r</i> _{amax}	<i>r</i> _{a1max}	<i>Y</i> ₁	<i>Y</i> ₂	<i>Y</i> ₀	<i>e</i>	kg	
		mm										
	LY-3033										1.9	
	LY-3032										1.3	
45T202211-1F2		110	180	5	2	2	0.81	0.8	1.2	0.8	18.6	
30220/DF/YA											7.78	
	LY-3016	117	145	5	2	2	0.28	2.3	3.6	2.3	6.04	
370622	87722	138	185	5	1.5	3	0.8	0.8	1.2	0.8	25.1	
	LY-3017	122	155	4	1.5	2	0.29	2.3	3.5	2.3	7.68	
31326/DF	3-772	158	218	8	1.5	3	0.83	0.8	1.2	0.8	42.4	
31330X/DF		181	251	9	3	1	0.83	0.81	1.2	0.8	58.5	
HM237546D/HM237510	3-759	191	266	5	1	2.5	0.32	2.1	3.2	2.1	31.5	
372038X2		208	258				1.47	2.2	1.46	0.46	25.8	
372038		202	272				1.5	2.2	1.4	0.46	23.4	
374140		230	290	10	2.5	2	0.52	1.3	1.9	1.3	52.6	
45T403818-1Y2		218				3	0.8				91.3	
EE420800D/421450	3-758	240	310	5	2.5	2.5	0.4	1.7	2.5	1.6	76.2	
M244249DW/M244210		235	293		1.5		2.03		3.02	0.33	28.7	
LM249747D/LM249710		268	325	5	2.5	2.5	0.33	2	3	2	24.5	
EE73810D/738172	3-757	283	400	5	2.5	5	0.36	1.9	2.8	1.8	105	
M249748D/M249710/HC3											41.9	
372952 K		274				2.5	0.37				42.3	
370652		290	395	10	4	3	0.33	2	3	2	93.1	
370652/HC		290	395	10	4	3	0.33	2	3	2	93.1	
LM451349D/GWJ2/10J2/10D.J2		288	318				1.8	2.7		1.8	0.37	59.4
372956X2K		300	360	3	2.5		0.29	2.3	3.5	2.3	46.8	
370656K											80.9	

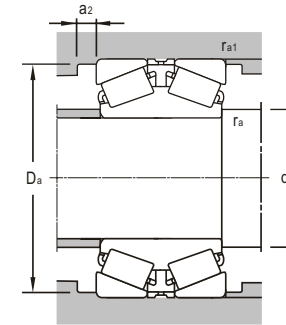
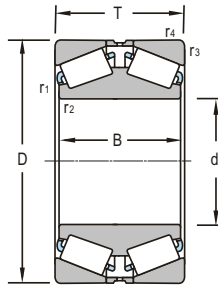

d 290~400mm

Boundary Dimensions						Basic Load Ratings	
d	D	T	B	r _{1,2min}	r _{3,4min}	Dynamic C	Static C ₀
mm						kN	
290	450		180	2.5	4	2140	4710
300	560	170	170	5	5	2280	3940
	560	170	170	5	5	2870	3340
300.038	422.275		150.813	3.3	3.3	1760	4210
305	480	200	200	3	4	2020	4200
	559.867	170.434	169.977	3.3	4.8	2304	4840
305.07	500		200	6.4	4.8	2370	5100
317.5	422.275		128.588	1.5	3.3	1650	3670
	447.675	158.75	158.75	3.2	3.2	1840	4640
320	620	280	280	5	5	5220	10300
	620	280	280	5	5	5220	10300
333.375	469.9		166.688	2	3	2080	5340
340	580		190	5	5	3060	6360
342.9	533.4	146.05	139.69	3.3	3.3	2160	4420
360	480		160	3	5	1970	5380
	560		160	3	5	2160	4560
	600	242	242	5	5	4350	9280
	680		330	2.5	5	5890	12300
368.3	523.875	185.738	185.738	3.3	6.4	2450	6730
380	567.5		180	2	4	2460	6230
	570		180	2	4	2460	6230
384.175	546.1	193.675	193.675	3.2	6.4	3030	8100
390	567.5	180	180	2	4	2460	6230
393.7	546.1		138.112	1.5	6.4	1930	4840
400	650		240	6.4	6.4	3310	7420

Bearing Designations		Mounting Dimensions					Calculation Factors				Mass
Present	Original	d _{amax}	D _{amin}	a ₂	r _{amax}	r _{a1max}	Y ₁	Y ₂	Y ₀	e	kg
		mm									
370658		312	382				1.07	1.59	1.05	0.64	102
370660/HC		322	535	5	5	4	0.81	0.8	1.2	0.8	196
370660-LS/HCC9		322	535	5	5	4	0.85	0.8	1.2	0.8	189
HM256849D-2/HM256810-2		322	394		3.3	3.3	2		2.99	0.34	66.3
45T614820-1GYZ		325	460	4	3	3	0.87	0.9	1.2	0.9	133
HM959649D/HM959618	3-770S	350	436	5	3	3	0.87	0.9	1.2	0.9	187
LY-3034K1		340	435				0.78	1.16	0.76	0.87	157
LM258648DW-1/LM258610-1		334	398		1.5		2.11		3.15	0.32	48.8
HM259049DE/HM259010		335	418	3.3	3.3		0.33	2	3	2	79.7
370664		385	512	10	5	4	0.43	1.6	2.3	1.6	414
370664-X2		385	512	10	5	4	0.43	1.6	2.3	1.6	414
HM261049DW-2/HM261010-2											96.7
LY-3103		370	510				1.13	1.68	1.1	0.6	207
EE971355D/972100		372	497	3.3	3.3		0.33	2	3	2	115
372972X2		370	448				2.05	3.05	2	0.33	81
370672/HCYA											139
374172X2		396	550	11	4	4	0.44	1.5	2.3	1.5	282
370672-2		418	630				1.1	1.6	1.07	0.62	552
HM265049TD/HM265010S		385	510	6.4	3.3		0.33	2	3	2	140
JM966741DW/JM966711W											160
LY-3108		412	548				0.9	1.35	0.89	0.74	163
HM266449DW/HM266410		407	508	6.4	3.3		0.33	2	3	2	152
JM966748DW/JM966711W-1		411	522	7	2	3	0.74	0.9	1.4	0.9	158
LM7674SOL/LM76710		418	510			1.5	1.42		2.12	0.47	98
LY-3042K10		420	548				0.78	1.16	0.76	0.87	304

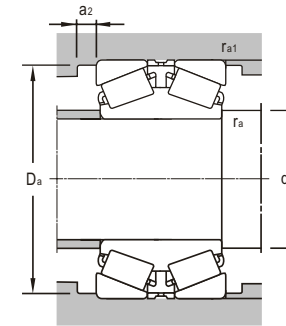
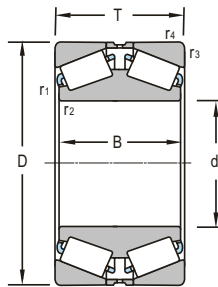

d 409.575--600.5mm

Boundary Dimensions						Basic Load Ratings	
<i>d</i>	<i>D</i>	<i>T</i>	<i>B</i>	<i>r</i> _{1,2min}	<i>r</i> _{3,4min}	Dynamic <i>C</i>	Static <i>C</i> ₀
mm						kN	
409.575	546.1	161.925	161.925	1.5	6.4	2160	6260
415.925	590.55	209.55	209.55	3.3	6.4	3520	9230
419.227	736.448	406.4	406.4	6	6	5294	10100
420	560	207.5	207.5	3	5	2890	7900
431.902	685.698	254	253.873	3.2	6.4	5080	11600
447.675	635	223.838	223.838	3.3	6.4	3800	10800
460	680		180	2.5	6	2740	6330
	860		380	2.5	5	8860	18700
	910		420	10	10	9270	18000
	950		450	6	5	11400	24400
480	950		440	9.5	9.5	10700	22200
	950	480	450	6	6	11400	24400
	950	500	500	6	6	12100	27000
482	655		160	3.3	3	2540	6560
489.026	634.873	152.4	152.4	3.3	3.3	2380	6990
500	720		185	6	6	3130	7360
501.65	673.1	184.15	184.15	3.3	6.4	3410	9380
520	715		180	2	5	3450	8770
540	860	256		7.5	7.5	5460	12100
571.5	812.8	285.75	285.75	3.2	6.4	4548	9192
580	830		280	3	6	6340	16600
595.312	844.55	296.862	296.862	6	6	4896	10668
600.5	819		172	6	6	3620	9020

Bearing Designations		Mounting Dimensions					Calculation Factors				Mass
Present	Original	<i>d</i> _{amax}	<i>D</i> _{amin}	<i>a</i> ₂	<i>r</i> _{amax}	<i>r</i> _{a1max}	<i>Y</i> ₁	<i>Y</i> ₂	<i>Y</i> ₀	<i>e</i>	kg
		mm									
M667947DW/M667910							0.43	1.6	2.3	1.6	110
M268749DW/M268710		420	575	6.4	3.3		0.33	2	3	2	206
EE323166D/323290	87984	440	702	25	5	5	0.26	2.6	3.9	2.6	799
370684K		434				2.5	0.3				143
EE328172DY/EE328269Y											391
M270749DW/M270710		475	591		6.4	3.3	0.33	2	3	2	236
373092X2/HC		473	623				0.78	1.16	0.76	0.87	220
374292X3/HC9		506	710				1.149		0.98	0.68	1107
LY-3099-1		526	820				1.32	1.97	1.29	0.52	1286
370692/C9YA											1675
370696X2/HC YB		560	760				0.97	1.44	0.94	0.7	1523
373396 X3		528	836	13	5	5	0.7	1	1.4	0.9	1623
370696/C9YA		540	833	7	5	5	0.7	1	1.4	0.9	1732
3706/482/HC		509	630				1.15	1.72	1.13	0.58	157
EE243193D/243250		508	602		3.3	3.3	0.35	1.9	2.9	1.8	130
500KD720HR		523	698				0.96	1.43	0.94	0.7	263
BT2B 332547/HA1							0.31	2.2	3.3	2.2	190
3706/520/HC		540	672				0.83	1.24	0.8	0.8	216
3706/540/HC YB		585	778	15	6	6	0.7	1	1.4	0.9	573
M278749D/278710	3-754	596	774	20	2.5	5	0.33	2	3	2	491
3706/580/HC/PS		602	802				2.14	1.05	2.1	0.31	507
M280049D/M280010	879/595	625	804	20	5	5	0.33	2	3	2	523
3706/600.5/HC		630	770				1.67	2.48	1.63	0.4	273

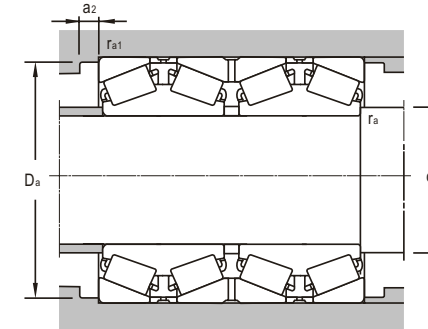
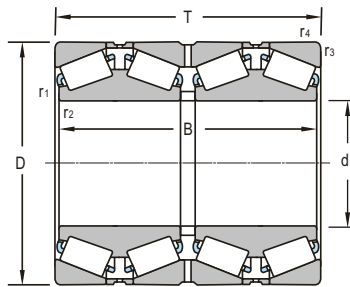

d 140~320mm

d	Boundary Dimensions					Basic Load Ratings	
	D	T	B	r _{1,2min}	r _{3,4min}	Dynamic C	Static C ₀
mm							
140	210	185	185	2.5	2	604	1095
170	260	230	230	2.5	2.5	907	1720
200	282	206	206	3	2.5	1117	2087
205	320	205	205	3	3	1254	1931
220	295	315	315	4	6	1470	4360
	295		315		3	1470	4360
300	230	230	230	3	2.5	1390	4080
340	305	305	305	4	3	1500	3020
340	305	305	305	4	3	2340	5520
240	338	248	248	4	4	2020	5320
	338		340		3	2490	7080
	360	310	310	4	3	2290	6240
250	365	270	270	3	3	1930	4750
	385	255	255	4	4	1913	4300
	388	248	248	4	4	2020	5320
260	360	265	265	3	2.5	1920	5150
	380	200	200	3	2.5	1730	4000
	400	255	255	4	7.5	2120	5010
	400	345	345	4	4	3750	7950
	440	284	330	5	2	3260	7600
	440	300	300	5	2	2597	5047
280	460	324	324	5	4	4100	7850
300	420	300	300	3	3	2253	4702
	460	390	390	5	4	3234	6832
	480	180	180	2.5	5	2050	4590
	500	350	350	5	4	3950	8830
	500	370	370	5	4	3654	6776
310	410	310	310	4.03	3.5	2330	6790
320	460	338	338	4	4	3056	7164
	460	380	380	4	4	3100	8000

Bearing Designations		Mounting Dimensions					Calculation Factors				Mass	
Present	Original	d _{amax}	D _{amin}	a ₂	r _{amax}	r _{a1max}	Y ₁	Y ₂	Y ₀	e	kg	
mm												
382028	382028	151	193	6.5	2.5	2	1.8	2.7	1.8	0.37	24.1	
382034	382034	180	236	6	2	2	1.6	2.3	1.5	0.44	39.5	
380640	380640	212	266	6	2.5	2	1.7	2.6	1.7	0.39	42.7	
380641	380641	220	304	16	2.5	2.5	1.5	2.2	1.4	0.46	54.5	
380644-ZLS	380644-ZLS	227	275	7		5	2	2.98	2	0.34	57.1	
380644YB		236	258				1.4	2.0		1.3	0.5	56.6
382944X2	382944X2	229	277	15	2.5	2	1.6	2.5	1.6	0.41	47.2	
382044	382044	234	314	15	3	2.5	1.9	2.8	1.9	0.35	97.9	
382044/HCYB2	382044/HCYB2	238	314	15	3	3	1.9	2.8	1.9	0.35	97	
37248WF/DPICS130	37248WF/DPICS130	258	308	6	3	3	1.7	2.6	1.7	0.39	69	
380648YB		260	306				1.7	2.5		1.6	0.4	93
382048/HC3	382048/HC3	258	325	15	3	2.5	1.9	2.8	1.9	0.36	111	
250KVE3601AEg	250KVE3601AEg						2.1	3.1	2.1	0.33	90.5	
380650	380650	270	364	20	3	3	1.8	2.7	1.7	0.38	108	
37248WF/DPICS130	37248WF/DPICS130										69.2	
382952	382952	274	337	20	2.5	2	1.8	2.7	1.8	0.37	78.4	
382952 X3	382952 X3	274	345	15	3	2.5	1.7	2.5	1.6	0.4	73	
380652	380652	278	370	8	3	3	1.4	2.6	1.7	0.39	115	
382052	382052	277	370	20	4	3	2.2	3.3	2.2	0.3	153	
477752	477752	282	418	20	4	4	2.1	3.2	2.1	0.32	168	
380152	380152	278	418	20	2	4	1	1.4	0.9	0.7	164	
381156	381156	304	423	20	4	3	2.1	3.1	2	0.33	200	
382960	2077960	317	394	20	3	2.5	2.3	3.4	2.3	0.29	130	
382060	2077160	320	425	20	4	3	2.2	3.2	2.1	0.31	238	
LY-3120		318	408				0.97	1.44		0.94	0.7	125
381060X2/HC												
381160	1077760	327	460	20	4	3	2.1	3.2	2.1	0.32	285	
380662-XRS/HCEP59-1/W281		330	403	7		3	2	3	2	0.33	132	
380664	77764	336	438	20	3	3	1.7	2.5	1.6	0.4	180	
380664YB2	77864	340	425	20	3	3	1.8	2.7	1.8	0.37	218	

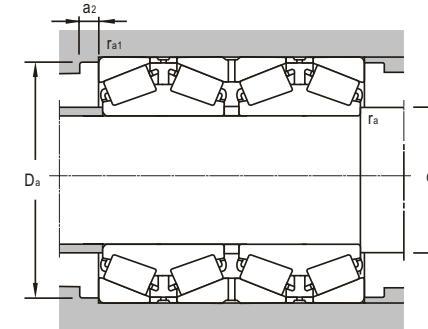
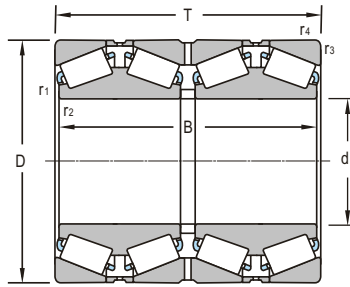

d 320~440mm

Boundary Dimensions						Basic Load Ratings	
<i>d</i>	<i>D</i>	<i>T</i>	<i>B</i>	<i>r</i> _{1,2min}	<i>r</i> _{3,4min}	Dynamic <i>C</i>	Static <i>C</i> ₀
mm						kN	
320	480	380	380	4	4	3470	9230
340	460	310	310	4	3	2478	5782
	460	310	310	4	3	2680	7930
	520	325	325	5	4	2898	5872
	520	325	325	5	4	4150	9120
580	425	425	425	5	4	4236	8450
350	590	420	420	2	5	4732	8582
360	480	310	310	4	3	2760	8360
	480	375	375	3	3	3038	3038
	540	325	325	5	4	3388	6524
380	560	325	325	5	4	3066	5754
	560	360	360	1.5	5	4850	12900
	620	420	420	5	4	5082	9604
385.762	514.35	317.5	317.5	0.7	3.3	3340	10200
390	510	350	350	4	3	3760	12100
395	545	288.7	268.7	4	7.5	1946	4032
400	540	280	280	4	4	1946	4032
	540	400	400	4	4	5260	11500
	540	400	400	4	4	4400	13800
	600	356	356	5	4	2618	6762
420	560	437	437	3	5	4950	15800
	620	356	356	5	4	3948	7616
	700	480	480	6	5	7308	12360
	760	500	500	7.5	7.5	7987	13328
440	620	454	454	6	6	5700	16000
	620	454	454	6	6	3962	7882
	620	454	454	6	6	5710	18300
	650	355	355	6	6	5030	13500
	650	355	355	6	6	6130	7400
	650	376	376	6	5	4326	9072

Bearing Designations		Mounting Dimensions					Calculation Factors				Mass
Present	Original	<i>d</i> _{amax}	<i>D</i> _{amin}	<i>a</i> ₂	<i>r</i> _{amax}	<i>r</i> _{1max}	<i>Y</i> ₁	<i>Y</i> ₂	<i>Y</i> ₀	<i>e</i>	kg
		mm									
382064/YB2	2077164	338	440	20	4	3	1.6	2.4	1.6	0.42	235
382968	2077968	355	434	20	3	2.5	2.2	3.2	2.1	0.31	145
		358	434	20	4	3	2.2	3.2	2.1	0.31	145
382968/HC C9		358	434	20	4	3	2.3	3.4	2.3	0.29	234
381068	77168	360	486	20	4	3	2.3	3.4	2.3	0.29	250
LY-3015		360	486	20	4	3	2.3	3.4	2.3	0.29	250
381168	1077768	365	531	20	4	3	1.6	2.4	1.6	0.42	441
380670	77770	368	560	20	2	4	1	1.4	0.9	0.7	475
382972		378	456	16	3	2.5	2.1	3.1	2	0.33	151
380672	77872	378	456	16	2.5	2.5	2	3	2	0.33	189
381072	77172	380	504	20	4	3	2.3	3.3	2.2	0.3	248
381076	77176	405	530	20	4	3	2.2	3.2	2.1	0.31	281
		524	402	20	1.5	4	1.6	2.3	1.5	0.43	304
		405	570	20	4	3	1.6	2.2	1.5	0.46	519
381176	1077776	405	570	20	4	3	1.6	2.2	1.5	0.46	519
3806/385.762-2LS		401	486	7		3	1.7	2.5	1.6	0.4	177
380678/HC		408	475	20	4	3	2.1	3.1	2	0.33	184
380679	77779	415	504	16	3	6	1.5	2.3	1.5	0.44	194
380680	77880	420	510	16	3	3	1.5	2.3	1.5	0.44	175
382980-2LS/YA3		2	3	2	0.33	250					
382980/HC	2077980S	420	510	16	3	3	2.2	3.2	2.1	0.31	258
381080	77180	420	560	20	4	3	1.7	2.5	1.6	0.4	317
382084X3/HC		440	530	16	2.5	4	2.2	3.2	2.1	0.31	292
381084	77184	450	570	20	4	3	1.6	2.5	1.6	0.41	358
381184	1077784	460	645	25	5	4	2.1	3.2	2.1	0.32	760
380684	77884	460	724	16	6	6	1.9	2.8	1.9	0.35	1039
440KVE6201EG		1.7	2.5	1.6	0.4	440					
380688	77888	469	570	20	5	5	1.7	2.5	1.6	0.4	440
380688W		469	570	20	5	5	1.7	2.5	1.6	0.4	438
380088FW		468	618	20	5	5	1.6	2.3	1.5	0.43	395
380088E/YB2	77888E	450	620	20	5	14	2.1	3.1	2	0.33	401
381088	77188	469	606	20	5	4	1.6	2.3	1.5	0.43	401

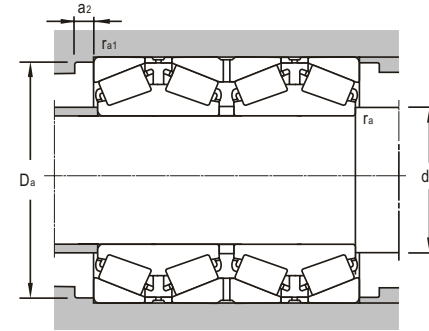
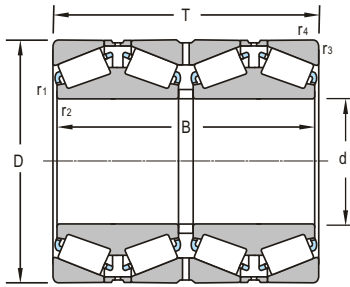

d 460--660mm

d	Boundary Dimensions					Basic Load Ratings	
	D	T	B	r _{1,2min}	r _{3,4min}	Dynamic C	Static C ₀
mm							
kN							
460	610		360	3	3.5	4480	13800
	620	310	310	4	3	3402	7350
	650	474	474	6	6	5292	11270
	680	410	410	6	5	5665	11235
	730	440	440	4	7.5	6062	11438
480	700	420	420	6	5	5922	12600
490	625	385	385	7	4	4510	15100
	625		385	3		4680	16000
500	720	420	420	6	5	5950	12768
510	655		377	6	6.4	5220	17900
530	730	535	535	5	5	8510	26800
	780	450	450	6	5	7602	15960
	870	590	590	7.5	6	10038	20300
	880	544	544	7.5	7.5	9394	18340
540	690		400	3	6	5630	19100
560	750	368	368	5	4	4424	10374
	920	620	620	7.5	6	12138	20300
570	810	590	590	3.3	6.4	10900	34600
600	800	380	380	5	4	4728	11652
	870	480	480	6	5	7212	15960
	980	650	650	7.5	6	11808	24480
625	815	480	480	3.3	6.4	8870	30400
630	850	418	418	6	5	7472	17600
	920	515	515	7.5	6	9975	20860
	1030	670	670	7.5	6	10755	31080
650	1030	560	560	7.5	12	11466	22050
660	1070	640	640	7.5	7.5	12600	26500

Bearing Designations		Mounting Dimensions					Calculation Factors				Mass
Present	Original	d _{amax}	D _{amin}	a ₂	r _{amax}	r _{a1max}	Y ₁	Y ₂	Y ₀	e	kg
mm											
380692-2LS		492	555				2	3	2	0.33	280
381992	1077992	480	590	25	3	2.5	1.7	2.5	1.7	0.4	173
380692	77892	484	580	25	5	4	1.7	2.5	1.6	0.41	495
381092	77192	489	636	25	5	4	2.2	3.2	2.1	0.31	476
380692/YB2	77792	489	694	25	3	6	0.9	1.3	0.9	0.75	694
381092	77196	510	655	25	5	4	2.1	3.2	2.1	0.32	547
490KV6201GS3/C9		520	590	25	6	3	2.1	3.2	2.1	0.32	279
380696-2LS/YA(511060530200052)		520	590	25	6	3	2.1	3.2	2.1	0.32	277
3810/500	771/500	530	674	25	5	4	2.1	3.1	2	0.33	565
NP90789/NP38221		526	628				2.05	3.04	0.98	0.33	316
3806/530/HC YB		550	682	25	4	4	2	3	2	0.33	681
3810/530	771/530	560	742	25	5	4	1.8	2.7	1.7	0.38	744
3811/530	10777/530	570	794	25	6	5	1.6	2.2	1.5	0.46	1422
3806/530	30777/530	570	794	25	6	6	1.6	2.2	1.5	0.46	1350
3806/540/HC		571	637				2	3	2	0.33	360
3819/560	10779/560	586	710	30	4	3	1.6	2.3	1.5	0.43	456
3811/560	10777/560	604	848	25	6	5	1.7	2.6	1.7	0.39	1635
3806/570		593	755	25	3	6	2	3	2	0.33	993
3819/600	10779/600	625	760	30	4	3	2.1	3.1	2	0.33	536
3810/600	771/600	630	821	30	5	4	1.6	2.5	1.6	0.41	995
3811/600	10777/600	644	908	25	6	5	2.1	3.2	2.1	0.32	1970
BT4-8031E/C800		653	769	20	3	5	2	3	2	0.33	659
3819/630	10779/630	657	800	30	5	4	1.7	2.5	1.6	0.4	720
3800/630	771/630	669	858	30	6	5	1.6	2.4	1.6	0.42	1158
3811/630	10777/630	673	959	30	6	5	2.2	3.3	2.2	0.3	2170
3806/650	777/650	684	962	30	6	9.5	2.1	3.2	2.1	0.3	1769
3806/660	777/660	738	950	12	6	6	2.2	3.2	2.1	0.31	2282

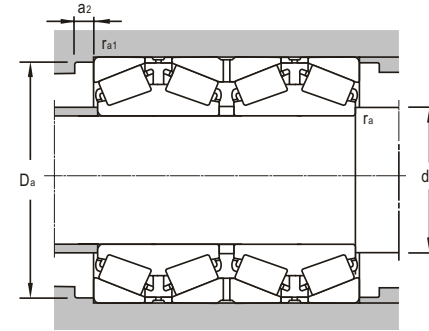
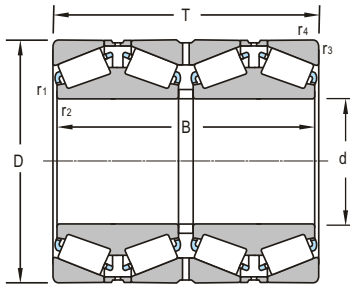

d 670~1060mm

Boundary Dimensions						Basic Load Ratings	
<i>d</i>	<i>D</i>	<i>T</i>	<i>B</i>	<i>r</i> _{1,2min}	<i>r</i> _{3,4min}	Dynamic <i>C</i>	Static <i>C</i> ₀
mm						kN	
670	900	412	412	6	5	7545	17360
710	1030 1150	555 750	555 750	7.5 9.5	6 8	9828 15840	22560 33960
711.2	899.4 914.4	390 390	390 390	3.3 2	6 5	7030 6060	24000 18700
750	1090 1130 1220 1220	605 690 840 840	605 690 840 840	7.5 7.5 9.5 9.5	6 7.5 8 8	11580 12720 18590 18590	26760 27960 41470 41470
800	1240	850	850	9.5	8	20600	67200
850	1360	900	900	12	9.5	25900	76000
950	1360	880	880	7.5	6	1700	44200
1060	1500	1000	1000	9.5	8	21300	56300

Bearing Designations		Mounting Dimensions					Calculation Factors				Mass
Present	Original	<i>d</i> _{amax}	<i>D</i> _{amin}	<i>a</i> ₂	<i>r</i> _{amax}	<i>r</i> _{1max}	<i>Y</i> ₁	<i>Y</i> ₂	<i>Y</i> ₀	<i>e</i>	kg
		mm									
3819/670	10779/670	700	855	30	5	4	1.5	2.3	1.5	0.44	959
3810/710	771/710	752	962	30	6	5	1.6	2.3	1.5	0.43	1568
3811/710	10777/710	762	1078	30	8	6	2.1	3.2	2.1	0.32	3227
3806/711.2		735	856	30	3	5	1.8	2.7	1.8	0.37	574
3806/711.2-2LS/YA4		742	865	7	2	4	1.8	2.7	1.7	0.38	602
3810/750	771/750	793	1020	30	6	5	1.6	2.4	1.6	0.42	1880
3806/750	777/750	790	1076	30	6	6	1.4	2.1	1.4	0.47	2549
3811/750	10777/750	807	1130	30	8	6	2.1	3.2	2.1	0.32	3994
3811/750/YA	10777/750Y	807	1130	30	8	6	2.1	3.2	2.1	0.32	3994
3811/750/YA1	10777/750Y1	807	1130	30	8	6	2.1	3.2	2.1	0.32	3994
3811/800 X1		816	1130	30	8	22	2.2	3.3	2.2	0.3	3950
3811/850	10777/850	900	1200	30	9.5	8	2	2.98	2	0.34	5168
3820/950	20771/950	1000	1290	30	6	5	2.6	3.8	2.5	0.26	4087
3820/1060	20771/1060	1117	1420	30	8	6	2.6	3.8	2.5	0.26	5698



Taper Roller Bearings

four-row (inch size)

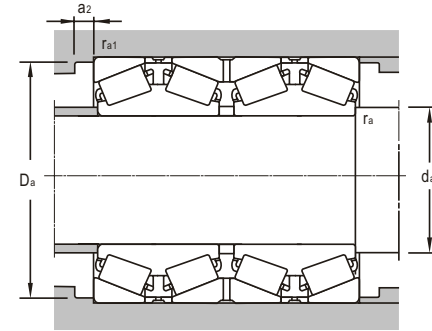
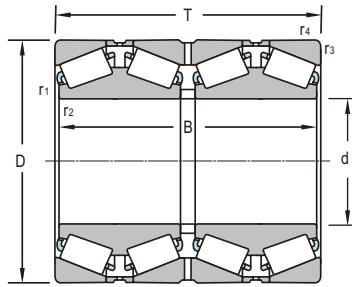

d 127~300. 038mm

Boundary Dimensions						Basic Load Ratings	
<i>d</i>	<i>D</i>	<i>T</i>	<i>B</i>	<i>r</i> _{1,2min}	<i>r</i> _{3,4min}	Dynamic <i>C</i>	Static <i>C</i> ₀
mm						kN	
127	182.562	158.75	158.75	1.5	3.3	721	1500
133.35	196.85		193.675		3.3	995	2100
139.7	200.025	160.34	157.165	0.8	3.3	727	2000
152.4	222.25	174.625	174.625	1.5	1.5	1050	2470
165.1	225.425	168.275	165.1	0.8	3.3	809	2100
181.808	259.969	161.925	144.465	1.5	0.5	747	1210
190.5	266.7	188.912	187.325	1.5	3.3	1250	3130
203.2	317.5	266.7	266.7	1.5	3.3	1720	4330
206.375	282.575	210	210	1	3.3	1320	3800
220.662	314.325	239.712	239.712	1.6	3.2	2050	5060
244.475	327.025	193.675	193.675	1.5	3.3	1720	4200
	381	304.8	304.8	3.3	4.8	2310	5850
254	358.775	269.875	269.875	3.5	3.3	2040	6220
	358.775		269.875		3.3	2070	5480
260.35	422.275	317.5	314.325	6.4	3.3	3480	7800
266.7	355.6	228.6	230.188	1.5	3.3	1643	5282
269.875	381	282.58	282.58	2.5	2.5	2710	6350
279.4	393.7	269.875	269.875	1.5	6.4	2240	6210
	393.7	269.875	269.875	2	5	2240	6210
		393.7	269.875	1.5	6.4	2850	6200
292.1	422.275	269.875	269.875	6.4	3.3	2540	6710
294.9	390		220	3	4	1720	4790
300.038	422.275	311.15	311.15	3.3	3.3	2960	8230

Bearing Designations		Mounting Dimensions					Calculation Factors				Mass
Present	Original	<i>d</i> _{amax}	<i>D</i> _{amin}	<i>a</i> ₂	<i>r</i> _{amax}	<i>r</i> _{a1max}	<i>Y</i> ₁	<i>Y</i> ₂	<i>Y</i> ₀	<i>e</i>	kg
		mm									
48290DW4822048220D		137	168	4.5	1.5	3.3	2.3	3.4	2.2	0.3	14
3806/133.35/IHC		142	180		3.3	1.5	2.9		2	0.34	19.1
46880D46820046820D		150	185	5.5	0.8	3.3	2	3	2	0.33	16
M231648DM231610/M231610D		164.5	207	4.5	1.5	1.5	2	3	2	0.33	22.5
46791D4672046721D		175	209	2.5	0.8	3.3	1.8	2.7	1.8	0.37	20.5
LM2395307LM239546TD/LM239549T	3-771	205	252	16	1.5	1	0.47	1.44	2.2	0.5	25.2
67885D6782067820D		204	246	4	1.5	3.3	1.4	2.1	1.4	0.48	33.5
93800DW9312593127D		222	286	8.5	1.5	3.3	1.3	1.9	1.3	0.53	77.5
206KV2857		268	216	8	1	3.3	1.6	2.3	0.43	1.5	38.6
M244248DM244210/M244210D		235	293	6.5	1.5	3	2	3	2	0.33	61.5
LM247748DWLM247710/LM247710D		260	300	8	1.5	2.5	2.1	3.1	2.1	0.32	44.1
EE126096D/EE126150/EE126151D		269	343	4	3.3	4.8	1.2	1.9	1.2	0.52	128
477513627AWFDPGCS130		273	335	7.5	3.3	3.3	2	3	2	0.33	85.6
3806/254-2L.SYA		267	335		3.3	1.5	2	3	2	0.33	81
HM252349D/HM252310/HM252310D		287	394	20	6	3	2	3	2	0.33	170
LM451349DWLM451310/LM451310D		281	335	7	1.5	3.3	1.8	2.8	1.8	0.36	59.4
M252349D/M252310/M252310D	3-729	290	356	8.5	2.5	2.5	2	3.1	2	0.33	99.9
EE135111D/EE135155/EE135156D		297	368	6	1.5	6.4	1.7	2.6	1.7	0.38	102
477563927AWHDPGCS155		297	368	6	1.5	3.3	1.7	2.5	1.7	0.4	97.5
KM652849DGM652811/KM652811D		304	361	9.5	6.4	1.6	1.77	2.64	1.73	0.38	105
EE330118D/330168/330167D		314	394	3	3.3	3.3	1.9	3.2	1.9	0.31	122
3806/294.9/IHC		309	368				2	3	2	0.34	68.6
HM256849D/HM256810/HM256810D/HG2		322	394		3.3	3.3	1.8	2.8	1.8	0.36	130



Taper Roller Bearings

four-row (inch size)

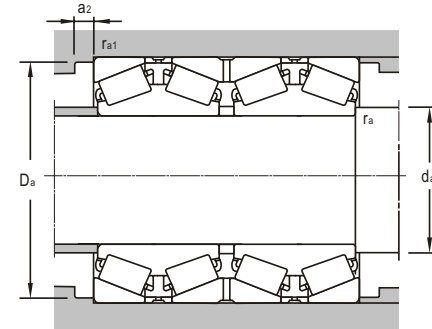
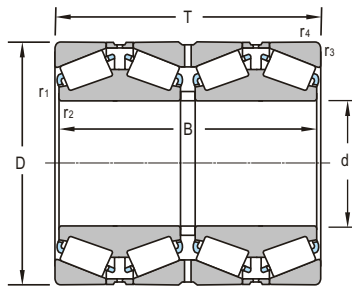

d 304.8~456.794mm

Boundary Dimensions						Basic Load Ratings	
d	D	T	B	r _{1,2min}	r _{3,4min}	Dynamic C	Static C ₀
mm						kN	
304.8	419.1	269.875	269.875	1.5	6.4	2500	7180
	501.65	336.55	336.55	3.3	6.4	4600	10600
304.902	412.648	266.7	266.7	3.2	3.2	2880	7100
	412.648		266.7	3.3	3.3	2490	7370
317.5	422.275		269.875		3.3	2320	6740
	447.675	327.025	327.025	3.2	3.2	2870	9280
341.312	457.098	254	254	2.5	6	2430	6870
342.9	533.4	301.625	307.985	3.2	3.2	2990	7370
343.052	457.089		254	1	3	2440	6920
	457.098	254	254	2.5	6	2475	6210
	457.098	254	254	2.5	6	2430	6870
	457.098	254	254	2.5	6	2430	6870
	457.098	254	254	1.8	4.7	2430	6870
355.6	457.2	252.413	252.413	1.6	3.2	2300	7420
	482.6	269.875	265.112	1.5	3.3	3030	7640
	482.6		265.113		3.3	2740	7720
374.65	501.65		250.825		3.5	2560	7110
384.175	546.1	400.05	400.05	3.2	6.4	5500	16200
385.762	514.35		317.5	3.3	3.3	3650	11300
	514.35		317.5	1	3.3	3340	10200
406.4	565.15	381	381	3.3	6.4	4950	14400
409.575	546.1	334.962	334.962	3.8	6.4	4460.09	11000
	546.1		334.962	1.5	6.4	3940	12000
	546.1		334.962	3.3	6.4	3410	10100
415.925	590.55	434.975	434.975	3.3	6.4	6820	18800
431.8	571.5	279.4	279.4	1.6	3.2	3470	9750
456.794	761.873		527.05	3.3	6.4	9580	23100

Bearing Designations		Mounting Dimensions					Calculation Factors				Mass
Present	Original	d _{amax}	D _{amin}	a ₂	r _{amax}	r _{amin}	Y ₁	Y ₂	Y ₀	e	kg
		mm									kg
M257148DWM257110/M257110D		322	392	6.5	1.5	6.4	2.1	3.1	2.1	0.32	128
HM25948D/HM25910/HM25910D		332	464		3.3	6.4	1.8	3	1.8	0.33	239
M257248DWM257210/M257210D	3-768	325	388	6.5	3.2	3.2	2.1	3.1	2.1	0.32	109
M257248DWS/H2S/H2S		327.1	385.5	7	3.2	3.2	2.12	3.15	2.07	0.32	104
3806/317.5-2LS		342	382				2.2	3.3	2.2	0.31	99
HM25948D/HM25910/HM25910D		340	418		3.2	3.2	2.1	3.1	2.1	0.33	162
LM761648D/LM761610/LM761610D		360	432	4.5	1.5	3.3	1.4	2.1	1.4	0.47	113
911355D/91100/91100D		360	479		3.2	3.2	2	3	2	0.33	239
BT4B328817E/IC475											109
LM761648D/LM761610/LM761610D	3-722	360	430	20	1.5	3	1.4	2.1	1.4	0.47	111
LM761648D/LM761610/LM761610D	3-722K	355	430	20	1.5	3	1.4	2.1	1.4	0.47	111
LM761648D/LM761610/LM761610D	3-722K1	355	430	20	1.5	3	1.4	2.1	1.4	0.47	109
LM761648D/LM761610/LM761610D		355	430	5	1.5	4	1.4	2.1	0.47	1.4	112
LM263148D/LM263110/LM263110D		372	434	6	1.5	3.2	1.9	3.1	1.9	0.32	98.9
LM763448D/LM763410/LM763410D		375	453	3.5	1.5	3.3	1.4	2.1	1.4	0.48	140
LY-3126		380	436				1.5	2.2	1.4	0.46	136
3806/374.65-2LS		400	452				1.4	2.1	1.4	0.48	133
HM266448D/HM266410/HM266410D		411	507	12	3.2	6.4	2	3	2	0.33	310
LM665948D/LM665910/LM665910D		406	477.2	9	3.2	3.2	1.61	2.4	1.58	0.42	180
3806/385.762-2LS		414	460				1.6	2.3	1.6	0.43	177
M267948DWM267910/M267910D		425	528	5	3.3	6.4	2	3	2	0.33	291
409KV491GS3C3		431	510	9	3.3	6.4	1.4	2.1	1.4	0.42	208
M667947D/LM667910/LM667910D		431.6	510	8	6.4	1.6	1.62	2.42	1.59	0.42	211
3806/409.575-2LS		431	510	9	1.5	6	1.6	2.3	1.4	0.43	205
M288748D/M288710/M288710D		444	549		1.6	3.2	2	3	2	0.33	395
LM669448D/LM669410/LM669410D		453	534	5	1.5	3.2	1.25	1.85	1.3	0.54	200
EE42176D/M252942529D		520	685	8	6.4	3.2	1.52	2.26	1.49	0.44	993



Taper Roller Bearings

four-row (inch size)

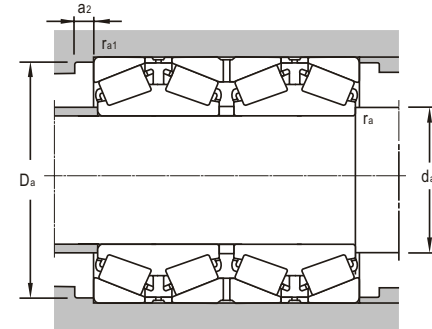
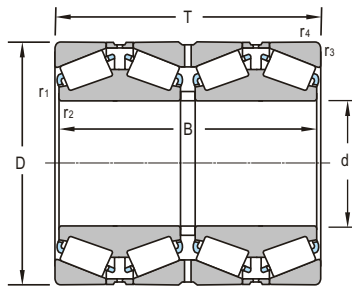

d 457.2~711.2mm

Boundary Dimensions						Basic Load Ratings	
d	D	T	B	r _{1,2min}	r _{3,4min}	Dynamic C	Static C ₀
mm						kN	
457.2	596.9	279.4	276.225	1.5	3.3	3090	9300
482.6	615.95	425	425	6.4	6.4	4110	13700
488.95	622.3	365.125	365.125	4	3	4900	14400
	622.3	365.125	365.125	6.4	6.4	3350	11100
501.65	711.2	520.7	520.7	5	5	7300	25600
	711.2	520.7	520.7	25	6.4	7130	21200
508	762	463.55	463.55	4	4	9500	22700
	762	463.55	463.55	25	4	7140	17800
558.8	736.6		450	3.3	6.4	6920	22900
	736.6		409.575	3.3	6.4	7440	20520
	736.6	457.2	593.72	3.3	6.4	7370	24500
	736.6	409.575	409.575	3.3	6.4	6010	19100
571.5	812.8	593.72	593.72	3.2		12500	35000
584.2	762	401.638	369.875	3.3	6.4	6030	20400
	762		396.875	3.3	6.4	5840	19500
585.788	771.525	479.425	479.425	3.3	6.4	7610	24600
	771.525		479.425	3.3	6.4	7610	24600
	771.525	479.425	479.425	3.3	6.4	7710	25100
	771.525	479.425	479.425	3.3	6.4	7710	25100
595.312	844.55		615.9	3.3	6.4	11900	37400
603.25	857.25		622.3	3.3	6.4	13400	37700
	857.25		622.3	3.3	6.4	13400	37700
660.011	855.015	319.99	319.99	5	5	5490	17700
685.8	876.3	355.6	352.42	2.5	4	7400	22200
	876.3	355.6	352.42	3.3	6.4	5200	16500
711.2	914.4	390	390	2	5	6060	18700

Bearing Designations		Mounting Dimensions					Calculation Factors				Mass
Present	Original	d _{amax}	D _{amin}	a ₂	r _{amax}	r _{amin}	Y ₁	Y ₂	Y ₀	e	kg
		mm									kg
L770847DW/L770810/L770810D		504	561	6	1.5	3.3	1.4	2.1	1.4	0.4	200
3806/482.6-2LS/YA3							2	3	2	0.33	300
3806/488.95	3-720	516	585	10	3.3	2.5	2	3	2	0.33	266
3806/488.95-2LS/YA3							1.7	2.5	1.7	0.39	262
3806/501.65-2LS/YA3	3-755	534	663		3.3	3.3	2	3	2	0.33	699
							1.7	2.8	1.7	0.36	655
EES3120/D/EES31300/S3101/XD	3-721	533	717	8	3.3	3.3	1.8	2.6	1.8	0.38	715
3806/508-2LS/YA3							1.6	2.7	1.6	0.37	708
3806/558.8/HFC		597	670				1.9	2.9	1.8	0.35	514
LM37748D/LM377410/LM377410CD		580	712	11	6.4	3.2	1.95	2.93	1.93	0.35	470
LM27748D/LM277110/LM277110D/L2		580	696	10	3.3	6.4	1.9	2.8	1.9	0.35	527
LM37748D/LM377410/LM377410CD		583	696	8	3.3	6.4	1.9	2.8	1.9	0.35	461
M278748D/M278710/M278710D	3-752	609	756		3.2	6.4	2	3	2	0.33	1007
LM778548D/LM778510/LM778510D		608	717	8	3.3	6.4	1.4	2.1	1.4	0.47	488
LM778548D/LM778510/LM778510D		618	715	8.5	6.4	3.2	1.43	2.12	1.4	0.47	472
LM278848D/LM278810-1/LM278810D-1		610	726	8	3.3	6.4	2	3	2	0.33	586
LM278848D/LM278810-3/LM278810D-3(1008)		622	725	9.5	6.4	3.2	2.03	3.02	1.98	0.33	586
LM278848D/LM278810/LM278810D		615	726	5	3.3	6.4	2	3	2	0.33	594
LM278848D/LM278810/LM278810D		615	726	5	3.3	6.4	2	3	2	0.33	594
M280048D/GW/J5/10/J5/10/J5		653	749				2	3	2	0.33	1162
M280248D/GWA/10A/10C		652	788	12	6.4	3.2	2.03	3.02	1.98	0.33	1177
M280248D/GWA/10A/10C		652	788	12	6.4	3.2	2.03	3.02	1.98	0.33	1177
660/V852G53		684	810	10	3.3	3.3	1.2	1.9	1.2	0.52	466
EE655271D/W/655345/655348D	3-719	717	831	3	2.5	4	1.6	2.4	1.6	0.41	579
3806/685.8-2LS/YA3							1.6	2.7	1.6	0.37	529
3806/711.2-2LS/YA3		753	873	4	2	5	1.6	2.7	1.6	0.38	615

Thrust Ball Bearings



..... 371

Single Direction Thrust Ball Bearings with Flat Back Face

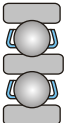

..... 383

Double-Direction Thrust Ball Bearings with Flat Back Face



..... 385

Angular Contact Thrust Ball Bearings

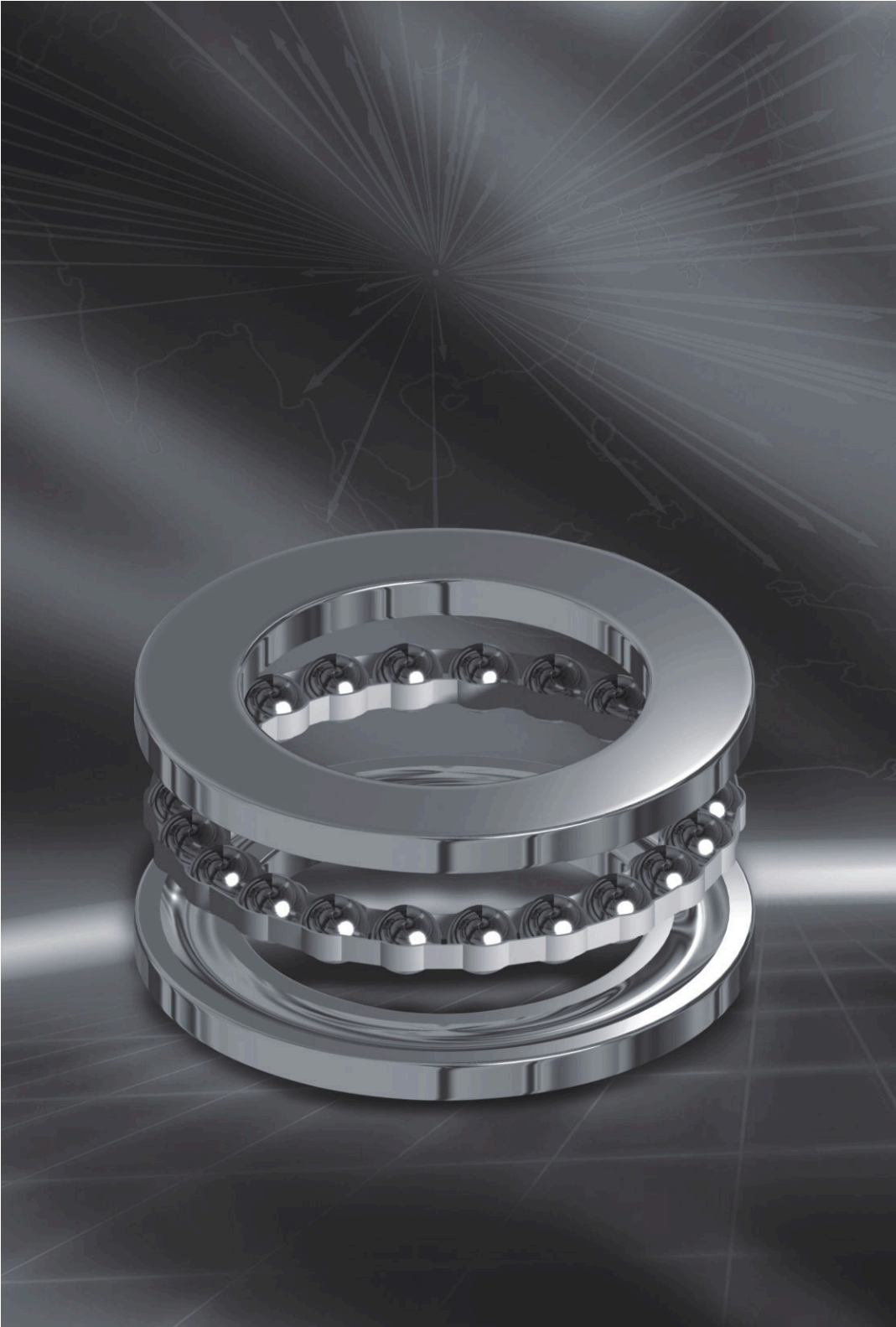

Thrust Ball Bearings

LYC's thrust ball bearings are separable, including a shaft washer (fit with journal), a housing washer (fit with bearing block), a group of steel balls and a cage, this makes it very convenient to fit with a journal and bearing block respectively.

LYC's thrust ball bearings have different structures and can be divided into single direction thrust ball bearings, double directions thrust ball bearings and angular contact thrust ball bearings.

Single Direction Thrust Ball Bearings

The single direction thrust ball bearings can only be used to carry axial load in one direction. Single direction thrust ball bearings have planar housing washer and an aligning seat washer. Generally, planar housing washer will not allow any angular error, however, when designing bracing structures, a gap of 0.5-1mm between the outer diameter of housing washer and the fitting surface of bearing block can be kept to correct the angular errors, which, would be made when mounting. Please note aligning housing washer needs to be ordered additionally.

Double-Direction Thrust Ball Bearings

Double-direction thrust ball bearing can carry axial loads in double directions, but it can not carry radial load. Double-direction thrust ball bearings can make an axial location in two directions. Double-direction thrust ball bearings also have planar housing washer and self-aligning seat washer. Generally, planar housing washer cannot allow any angular error, however, when designing bracing structures, a gap of 0.5-1mm between the outer diameter of housing washer and the fitting surface of bearing block can be kept to correct the angular errors, which, would be made when mounting. Self-aligning housing washer need to be ordered and manufactured separately.

Angular Contact Thrust Ball Bearings

The angular contact thrust ball bearing mainly carries axial load, and it can also carry a certain radial load. Compared with thrust ball bearings of the same dimension, the limiting speed is also higher. It can make an axial location in one direction.

Angular contact thrust ball bearings can make up for the weakness of the thrust ball bearings with flat back face which cannot carry radial loads. The contact angles are 45° and 60° . The smaller the degree of contact angle, the higher the capacity of the radial load is.

Thrust Ball Bearing with Outer Cover

The structure of thrust ball bearing with outer cover is the same as that of single direction thrust ball bearing, but, there is an outer cover on the seat washer (or there are outer covers on the inner and outer diameters of a seat washer). The structure is as Fig.1 and Fig.2. Thrust ball bearings with an outer cover are non-separable because of the outer cover. The outer cover is used for dust-proofing. The structure of Fig.2 can also be filled with lubricants.

The thrust ball bearing with an outer cover can carry axial loads in one direction, but, it cannot carry radial loads. It also can make an axial location in one direction.



Fig. 1

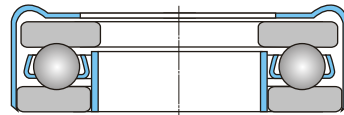

Fig. 2

LYC can provide thrust ball bearings with other special structures, such as thrust ball bearings without cages, unidirectional thrust ball bearings with taper bores, unidirectional thrust ball bearings with steel wire raceway and etc. All the types cannot be listed in this catalogue. If customers have special requirements, please consult LYC technical department.

Cage

Cages of thrust ball bearings supplied by LYC are pressed steel cages, machined solid cages made of brass or bronze, special fabric reinforced phenolic resin cages, etc. Cages of different material are identified by a suffix. Further details can be found in LYC catalogue "Bearing Material".

Minimum Load

In order to keep bearings working in a good condition, a minimum load must be imposed on bearings, particularly on bearings working at high speeds, high accelerations, or with the load direction changing frequently, because under these working conditions, inertial force of balls and cage and lubricant friction will have bad influence

on the rotation of bearings, and detrimental sliding movement may be caused.

The minimum load of a thrust ball bearing can be obtained from

where

$$F_{\min} = A \left(\frac{n}{1000} \right)^2 \text{ kN}$$

A — Minimum load constant, see bearing dimension tables

N — speed, r/min

When bearings are started at low ambient temperatures or in the condition where the viscosity of lubricant is very high, a larger minimum load is required. Usually, the weight of the bearing supporting parts plus the load on the bearing have been over the minimum load. If the weight cannot be up to the minimum load, then extra radial load must be exerted on this type of bearing in order to meet the requirement of minimum load. The requirement can be met through preloading in axial with springs.

Dimension, Tolerance

The boundary dimension of LYC's standard thrust ball bearings is according to the standards of GB/T273.2 <Rolling Bearing, Thrust Bearing, and Boundary Dimension General Specification>, GB/T301 <Rolling Bearings, Thrust Ball Bearings, and Boundary Dimensions>.

The tolerance of LYC's standard thrust ball bearings is according to the standards of GB/T307.4 <Rolling Bearing, Thrust Bearing, and Tolerance>.

The dimensional tolerance of LYC's standard thrust ball bearing is the normal grade P0. If customers have other special requirements on dimension, tolerance, and clearance, LYC have the ability to supply you the corresponding products, including non-standard products.

Equivalent Dynamic Load

The equivalent dynamic load of thrust ball bearings can be calculated from

$$\text{when } \alpha = 90^\circ \quad P = F_a$$

$$\text{when } \alpha \neq 90^\circ \quad P = X F_r + Y F_a$$

Single Direction Bearing:

while $\alpha = 45^\circ$

$$F_a / F_r > e \quad \begin{matrix} X = 0.66 \\ Y = 1 \\ e = 1.25 \end{matrix}$$

while $\alpha = 60^\circ$

$$F_a / F_r > e \quad \begin{matrix} X = 0.92 \\ Y = 1 \\ e = 2.17 \end{matrix}$$

Double-Direction Bearing

while $\alpha = 45^\circ$

$$F_a / F_r > e \quad \begin{matrix} X = 0.66 \\ Y = 1 \\ e = 1.25 \end{matrix}$$

$$F_a / F_r \leq e \quad \begin{matrix} X = 1.18 \\ Y = 0.59 \\ e = 1.25 \end{matrix}$$

while $\alpha = 60^\circ$

$$F_a / F_r > e \quad \begin{matrix} X = 0.92 \\ Y = 1 \\ e = 1.25 \end{matrix}$$

$$F_a / F_r \leq e \quad \begin{matrix} X = 1.9 \\ Y = 0.55 \\ e = 2.17 \end{matrix}$$

Equivalent Static Load

The equivalent static load of thrust ball bearings can be calculated from

$$\text{when } \alpha = 90^\circ \quad P_0 = F_a$$

$$\text{when } \alpha \neq 90^\circ \quad P_0 = F_a + 2.3 F_r \cdot \tan \alpha$$

where

F_a — Radial load, N

F_r — Axial load, N

α — Contact angle

X — Radial load factor

Y — Axial load factor

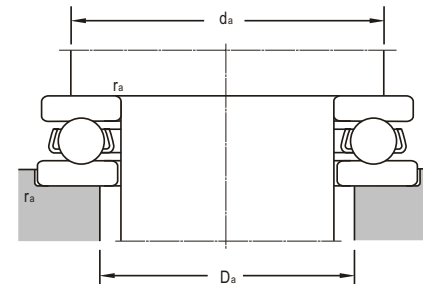
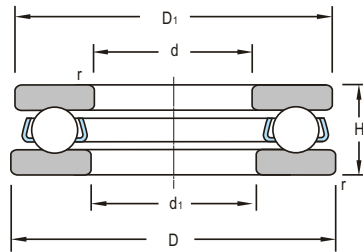

d 10~45mm

Boundary Dimensions						Basic Load Ratings		Limiting Speeds	
d	d _{min}	D	D _{1max}	H	r _{min}	Dynamic C	Static C ₀	Grease	Oil
mm						kN		r/min	
10	11	24	24	9	0.3	10	13.3	7000	9500
	12	26	26	11	0.6	12.7	16.2	6000	8000
12	13	26	26	9	0.3	10.3	14.5	7000	9500
	14	28	28	11	0.6	13.2	18.1	6000	8000
15	16	28	28	9	0.3	10.5	13.3	6300	8500
	17	32	32	12	0.6	14.2	15.8	5300	7000
	15.2	32	32	12	0.6	14.2	15.8	5300	7000
17	18	30	30	9	0.3	10.8	13.4	6300	8500
	19	35	35	12	0.6	17.2	26.1	5300	7000
20	21	35	35	10	0.3	13.4	18.6	5600	7500
	22	40	40	14	0.6	22.3	35.6	4500	6000
25	26	42	42	11	0.6	17.4	27.6	4800	6300
	25.2	47	47	15	0.6	27.8	47.5	4000	5300
	27	52	52	18	1	35.7	52.3	3400	4500
	27	60	60	24	1	55.5	85.5	2600	3600
30	32	47	47	11	0.6	18.1	31.8	4500	6000
	32	52	52	16	0.6	28.1	45.1	3600	4800
	32	60	60	21	1	42.8	62.2	2800	3800
	32	70	70	28	1	72.7	119	2200	3200
35	37	52	52	12	0.6	21.2	38.2	4300	5600
	35.2	62	62	18	1	39.2	63.7	3200	4300
	37	68	68	24	1	55.4	83.6	2400	3400
	37	80	80	32	1.1	87	148	1800	2600
40	42	60	60	13	0.6	26.9	47.5	3800	5000
	42	68	68	19	1	47	93.1	2800	3800
	42	78	78	26	1	69.2	106	2000	3000
	42	90	90	36	1.1	112	194	1700	2400
45	47	65	65	14	0.6	27	54.2	3400	4500
	47	65	65	14	0.6	31.6	108	3400	4500
	47	73	73	20	1	47.8	81	2600	3600
	47	85	85	28	1	75.8	133	1900	2800
	47	100	100	39	1.1	141	228	1600	2200

Bearing Designations		Minimum Load Constant A	Mounting Dimensions			Mass
Present	Original		d _a	D _a	r _{max}	
			mm			kg
*51100	8100	0.002	19	15	0.3	0.02
*51200	8200	0.003	20	16	0.6	0.03
*51101	8101	0.002	21	17	0.3	0.022
*51201	8201	0.003	22	18	0.6	0.035
*51102	8102	0.003	23	20	0.3	0.024
51202	8202	0.005	23	20	0.3	0.044
51202/YB2	8202K	0.005	25	22	0.6	0.0451
51103	8103	0.003	25	22	0.3	0.0242
*51203	8203	0.006	28	24	0.6	0.053
51104	8104	0.005	29	26	0.3	0.0372
*51204	8204	0.009	32	28	0.6	0.08
51105	8105	0.007	35	32	0.6	0.06
51205	8205	0.018	38	34	0.6	0.112
51305	8305	0.026	41	36	1	0.18
*51405	8405	0.053	46	39	1	0.34
*51106	8106	0.009	40	37	0.6	0.07
51206	8206	0.02	43	39	0.6	0.137
51306	8306	0.046	48	42	1	0.252
*51406	8406	0.084	54	46	1	0.53
51107	8107	0.014	45	42	0.6	0.0836
51207	8207	0.04	56	46	1	0.22
*51307	8307	0.072	55	48	1	0.39
*51407	8407	0.17	62	53	1	0.82
*51108	8108	0.027	52	48	0.6	0.12
51208	8208	0.055	57	51	1	0.27
51308	8308	0.103	63	55	1	0.426
*51408	8408	0.275	70	60	1	1.18
*51109	8109	0.027	57	53	0.6	0.15
*51109M	8109	0.027	57	53	0.6	0.16
*51209	8209	0.072	62	56	1	0.32
51309	8309	0.148	69	61	1	0.665
*51409	8409	0.442	78	67	1	1.64

single direction thrust ball bearings with flat back face

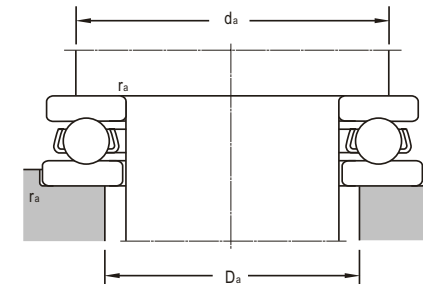
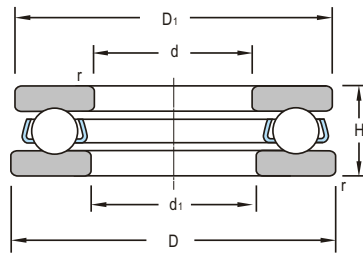

d 50~90mm

Boundary Dimensions						Basic Load Ratings		Limiting Speeds	
d	d _{1min}	D	D _{1max}	H	r _{min}	Dynamic C	Static C ₀	Grease	Oil
mm						kN		r/min	
50	52	70	70	14	0.6	27.1	59.9	3400	4500
	52	78	78	22	1	48.5	101	2400	3400
	52	95	95	31	1.1	96.6	164	1800	2600
	52	110	110	43	1.5	160	295	1500	2000
55	57	78	78	16	0.6	34.4	74.1	3000	4000
	57	90	90	25	1	67.6	127	2000	3000
	57	105	105	35	1.1	114.5	198	1600	2200
	57	120	120	48	1.5	183	342	1300	1800
60	62	85	85	17	1	40.3	87	2600	3600
	62	95	95	26	1	73.6	141	1900	2800
	62	110	110	35	1.1	118	208	1600	2200
	62	130	130	51	1.5	201	380	1200	1700
65	67	90	90	18	1	41.7	103	2400	3400
	67	100	100	27	1	74.9	151	1800	2600
	67	115	115	36	1.1	116	228	1600	2200
	68	140	140	56	2	217	428	1000	1500
70	72	95	95	18	1	42	119	2400	3400
	72	105	105	27	1	73.6	161	1800	2600
	72	125	125	40	1.1	148	285	1400	1900
	73	150	150	60	2	257	475	950	1400
75	77	100	100	19	1	44	130	2200	3200
	77	110	110	27	1	74.9	173	1700	2400
	77	135	135	44	1.5	163	342	1200	1700
	78	160	160	65	2	269	532	900	1300
80	82	105	105	19	1	48.8	133	2000	3000
	82	115	115	28	1	83.8	193	1700	2400
	82	140	140	44	1.5	178	342	1200	1700
	83	170	170	68	2.1	292	589	850	1200
85	87	110	110	19	1	49.2	143	2000	3000
	88	125	125	31	1	103	238	1600	2200
	88	150	150	49	1.5	209	404	1100	1600
	88	180	177	72	2.1	318	646	850	1200
90	92	120	120	22	1	65.1	181	1800	2600

Bearing Designations		Minimum Load Constant A	Mounting Dimensions			Mass
Present	Original		d _a	D _a	r _{max}	
			mm			kg
51110	8110	0.032	62	58	0.6	0.16
*51210	8210	0.097	67	61	1	0.375
*51310	8310	0.266	77	68	1	1
*51410	8410	0.589	86	74	1.5	1.99
51111	8111	0.068	69	64	0.6	0.232
*51211	8211	0.168	76	69	1	0.61
*51311	8311	0.393	85	75	1	1.34
*51411	8411	0.834	94	81	1.5	2.6
*51112	8112	0.07	75	70	1	0.29
*51212	8212	0.207	81	74	1	0.69
*51312	8312	0.462	90	80	1	1.43
*51412	8412	1.326	102	88	1.5	3.3
*51113	8113	0.099	80	75	1	0.34
*51213	8213	0.226	86	79	1	0.77
*51313	8313	0.638	95	85	1	1.57
*51413	8413	1.48	110	95	2	4.2
*51114	8114	0.119	85	80	1	0.36
*51214	8214	0.226	91	84	1	0.81
*51314	8314	0.756	103	92	1	1.932
*51414	8414	2.07	118	102	2	5.18
*51115	8115	0.128	90	85	1	0.42
*51215	8215	0.295	96	89	1	0.86
*51315	8315	1.04	111	99	1.5	2.7
*51415	8415	3.05	125	110	2	6.97
*51116	8116	0.138	95	90	1	0.43
*51216	8216	0.324	101	94	1	0.95
*51316	8316	1.19	116	104	1.5	2.58
*51416	8416	3.726	133	117	2	7.11
*51117	8117	0.148	100	95	1	0.46
*51217	8217	0.56	109	101	1	1.3
*51317	8317	1.766	123	111	1.5	3.7
*51417	8417	4.42	141	124	2	9.5
51118	8118	0.256	108	102	1	0.636

single direction thrust ball bearings with flat back face

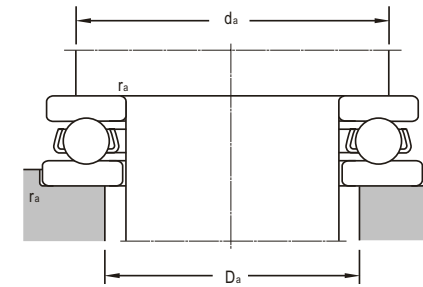
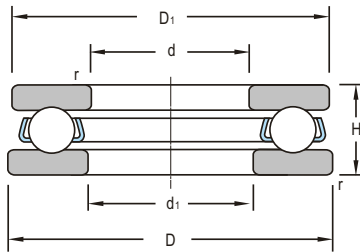

d 90~170mm

Boundary Dimensions						Basic Load Ratings		Limiting Speeds	
d	d _{1min}	D	D _{1max}	H	r _{min}	Dynamic C	Static C ₀	Grease	Oil
mm						kN		r/min	
90	93	135	135	35	1.1	125	285	1500	2000
	93	155	155	50	1.5	221	408	1000	1500
	93	190	187	77	2.1	327	713	800	1100
100	102	135	135	25	1	85.1	257	1700	2400
	103	150	150	38	1.1	149	347	1300	1800
	103	170	170	55	1.5	263	513	950	1400
	103	210	205	85	3	399	917	700	950
110	112	145	145	25	1	87.2	276	1600	2200
	113	160	160	38	1.1	139	393	1200	1700
	113	190	187	63	2	280	684	850	1200
	113	230	225	95	3	415	1150	630	850
	113	230	225	95	3	491	1397	630	850
120	122	155	155	25	1	87.1	295	1600	2200
	123	170	170	39	1.1	136	399	1200	1700
	123	210	205	70	2.1	330	869	800	1100
130	132	170	170	30	1	109	371	1400	1900
	132	155	153	17	1	41.5	158	1500	2000
	133	190	187	45	1.5	186	535	950	1400
	134	225	220	75	2.1	358	1007	750	1000
	134	270	265	110	4	490	1520	560	750
140	142	180	178	31	1	111	380	1300	1800
	143	200	197	46	1.5	191	542	950	1400
	144	240	235	80	2.1	396	1159	700	950
	144	280	275	112	4	553	1750	500	700
150	152	190	188	31	1	112	380	1200	1700
	153	215	212	5	1.5	244	698	900	1300
	154	250	245	80	2.1	407	1226	670	900
160	162	200	198	31	1	112	404	1200	1700
	163	225	222	51	1.5	240	741	850	1200
	164	270	265	87	3	463	1425	630	850
170	172	215	213	34	1.1	137	475	1100	1600
	173	240	237	55	1.5	280	884	800	1100
	174	280	275	87	3	445	1520	600	800

Bearing Designations		Minimum Load Constant A	Mounting Dimensions			Mass
Present	Original		d _a	D _a	r _{max}	
			mm			kg
*51218	8218	0.746	117	108	1	1.77
51318M	8318	0.202	129	116	1.5	4.21
*51418	8418	6.09	149	131	2	11.2
*51120	8120	0.403	121	114	1	1
51220M	8220	1.226	130	120	1	2.51
51320M	8320	3.236	142	128	1.5	5.46
*51420	8420	9.606	165	145	2.5	14.9
51122	8122	0.48	131	124	1	1.08
*51222	8222	1.58	140	130	1	2.6
*51322	8322	4.216	158	142	2	7.9
*51422	8422	12.7	181	159	2.5	20
51422/HE		12.7	181	159	2.5	20.6
*51124	8124	0.48	141	134	1	1.16
*51224	8224	1.58	150	140	1	2.9
51324	8324	6.176	173	157	2	9.75
*51126	8126	0.922	154	146	1	1.87
LY-5014			144	141	1	0.603
51226	8226	2.85	166	154	1.5	4.2
*51326	8326	7.36	186	169	2	13.3
*51426	8426	26.3	213	187	3	32
*51128	8128	0.99	164	156	1	2.1
*51228	8228	3.15	176	164	1.5	4.5
*51328	8328	10.4	199	181	2	15.9
*51428	8428	26.3	222	198	3	32.2
*51130	8130	1.09	174	166	1	2.2
*51230	8230	4.13	189	176	1.5	5.8
*51330	8330	12	209	191	2	16.7
*51132	8132	1.276	184	176	1	2.3
*51232	8232	4.52	199	186	1.5	6.7
*51332	8332	16.3	225	205	2.5	21.5
*51134	8134	1.58	197	188	1	3.3
*51234	8234	5.196	212	198	1.5	8.3
*51334	8334	16.3	235	215	2.5	22.5

single direction thrust ball bearings with flat back face

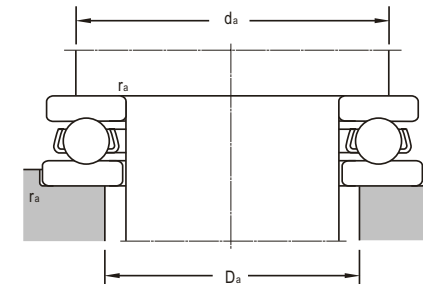
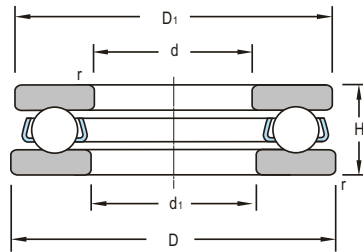

d 170~400mm

Boundary Dimensions						Basic Load Ratings		Limiting Speeds	
d	d _{min}	D	D _{1max}	H	r _{min}	Dynamic C	Static C ₀	Grease	Oil
mm						kN		r/min	
170	172	215	213	34	1.1	137	475	1100	1600
	173	240	237	55	1.5	280	884	800	1100
	174	280	275	87	3	445	1520	600	800
180	183	225	222	34	1.1	135	504	1000	1500
	183	250	247	56	1.5	294	950	800	1100
	184	300	295	95	3	494	1738	560	750
190	195	320	315	105	4	544	1480	520	700
200	205	340	335	110	4	624	2400	500	700
220	223	270	267	37	1.1	179	740	950	1400
238	242	340	340	70	3.5	365	1140	580	750
260	263	320	317	45	1.5	218	994	800	1100
	264	360	355	79	2.1	450	1900	560	750
280	284	380	375	80	2.1	493	1950	560	750
300	304	380	376	62	2	322	1634	630	850
	304	420	415	95	3	575	2613	480	630
320	324	400	396	63	2	352	1756	600	800
	325	440	435	95	3	543	2565	450	600
340	344	420	416	64	2	358	1768	600	800
	345	460	455	96	3	575	2755	450	600
	345	540	535	160	5	1020	5100	200	250
360	364	440	436	36	2	371	1805	560	750
	364	440	436	65	2	371	1890	560	750
	365	500	495	110	4	704	3610	400	530
365	365.4	475	400	95	3				
370	368	529	529	131	6				
400	400.4	440	440	24	1	140	700	1300	1600
	404	480	476	65	2	403	2014	530	700

Bearing Designations		Minimum Load Constant A	Mounting Dimensions			Mass
Present	Original		d _a	D _a	r _{max}	
			mm			kg
*51134	8134	1.58	197	188	1	3.3
*51234	8234	5.196	212	198	1.5	8.3
*51334	8334	16.3	235	215	2.5	22.5
*51136	8136	2.356	207	198	1	3.5
51236	8236	6.276	222	208	1.5	8.08
*51336	8336	21.7	251	229	2.5	28.7
51338M		27.8	308	202	3	36
LY-Z093		35	282	258	3	41.8
51144			250	240	1	4.6
8949M		35	335	252	3	19.6
51152	8152	0.856	296	284	1.5	7.96
*51252	8252	1.9	319	301	2	24.8
51256			339	321	2	27
51160	8160	22.46	348	332	2	17.3
51260	8260	46.2	371	349	2.5	42.5
51164	8164	23.91	368	352	2	18.76
51264	8264	55.2	391	369	2.5	43
51168	8168	27.16	388	372	2	19.8
51268	8268	59.9	411	389	2.5	45
51368	8368	211.8	457	425	4	142
51172X2	7708172	1.805	408	392	2	11.3
51172	8172	28.86	408	392	2	21.1
51272	8272	101	443	417	3	69.2
	708773Y		1433	407	2.5	40.1
	8974H		1467	433	5	105
50980/YB2	9008980	119.5	426	414	1	4.47
51180	8180	36	448	432	2	23

single direction thrust ball bearings with flat back face

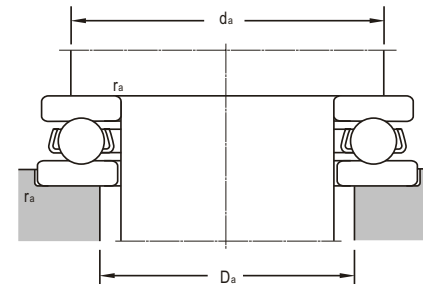
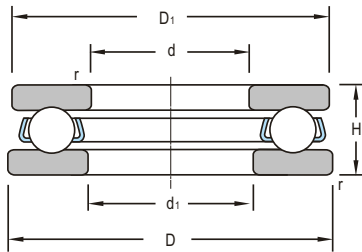

d 400~670mm

Boundary Dimensions						Basic Load Ratings		Limiting Speeds	
<i>d</i>	<i>d</i> _{min}	<i>D</i>	<i>D</i> _{max}	<i>H</i>	<i>r</i> _{min}	Dynamic <i>C</i>	Static <i>C</i> ₀	Grease	Oil
mm						kN		r/min	
400	405	540	535	112	4	730	3800	250	380
	405	540	535	85	4	668	3250	330	470
420	424	500	495	65	2	410	2090	530	700
	422	550	550	80	4	463	2574	500	650
440	444	540	535	80	2.1	552	2730	450	600
	444	540	535	60	2.1	360	2112	360	500
	445	600	595	130	5	904	4150	320	470
455	457	650	650	120	5	776	4851	350	500
460	464	560	555	80	2.1	527	2850	450	600
	465	620	615	130	5	688	4504	200	300
480	481	600	600	80	2.1	585	3165	448	640
	484	580	575	80	2.1	530	3100	430	560
	485	730	725	195	6	1065	6886	230	330
500	502	540	540	30	1	101	835	1100	1500
	504	600	595	80	2.1	595	3250	430	560
	505	670	665	135	5	864	5443	250	300
	505	750	745	150	6	950	6320	180	220
530	534	640	635	85	3	618	3311	400	530
560	560.6	610	610	30	1.1	128	960	560	800
600	604	710	705	67	3	630	4275	380	500
	604	710	705	85	3	689	4445	360	470
630	634	750	745	95	3	744	4680	350	480
	635	850	845	175	6	1400	10000	100	160
	635	810	805	100	6	894	5058	302	432
635	635	787.4	787.4	88.9	3	730	4690	341	488
670	670	800	800	95	4	852	4900	318	454
	672	730	730	45	1.5	284	2160	380	530
	674	800	795	105	4	683	5778	160	240

Bearing Designations		Minimum Load Constant <i>A</i>	Mounting Dimensions			Mass
Present	Original		<i>d</i> _a	<i>D</i> _a	<i>r</i> _{max}	
			mm			kg
51280	8280	119.5	484	458	3	74.5
59280	9008280	3.25	484	458	3	53.4
51184	8184	39.1	468	452	2	24.2
51784	8784	2.574	468	452	2	53.6
51188	8188	2.7	499	481	2	39
59188/YB2	9008188	38	499	481	2	28.2
51288	8288	126.3	537	505	4	109
51791	8791	4.851	560	544	4	131
51192	8192	70.7	518	502	2	41.7
51292	8292	176.6	557	525	4	114
51196X1	8196K	3.165	548	532	2	53.1
51196	8196	78.5	538	522	2	42.5
51396	8396	6.886	620	590	5	308
510/500	10089/500	0.835	527	513	1	6.66
511/500	81/500	82.66	559	541	2	45.7
512/500	82/500	248.4	601	569	4	137
593/500	90083/500	6.32	641	609	5	228
511/530	81/530	123.6	595	575	2.5	55.8
590/560	90089/560	6.6	592	578	1	9.55
591/600	90081/600	4.275	665	645	2.5	50.1
511/600			665	645	2.5	63.5
511/630			1700	680	2.5	81.7
512/630	82/630	558.7	759	721	5	243
517/630	87/630	5.058	1700	680	5	126
517/635/YB2	87/635K	4.69	721	701	2.5	95.2
511/670X2	81/670K	4.85	748	722	3	93.5
510/670	10089/670	33	707	693	1.5	20.5
511/670	81/670	164.7	748	722	3	92.21

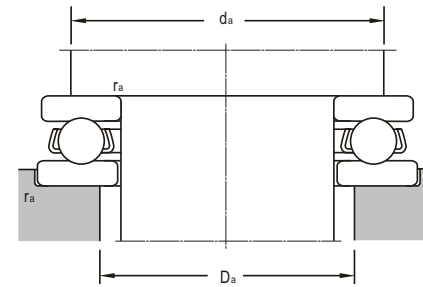
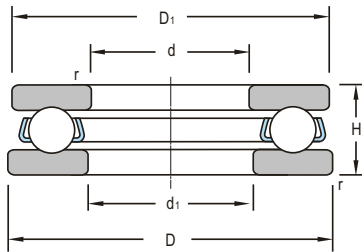

d 708 ~ 3000mm

Boundary Dimensions						Basic Load Ratings		Limiting Speeds	
<i>d</i>	<i>d</i> _{min}	<i>D</i>	<i>D</i> _{max}	<i>H</i>	<i>r</i> _{min}	Dynamic <i>C</i>	Static <i>C</i> ₀	Grease	Oil
mm						kN		r/min	
708	708	950	950	92.8	8	775	970	150	220
710	715 715	950 950	945 945	109 145	6 6	787 1025	980 1296	150 150	220 220
750	755 755	900 900	895 895	90 90	4 4	810 741	6210 4900	160 303	240 433
780	782	930	930	100	3.5	800	6069	140	200
800	805 805	1060 920	1055 915	205 100	7.5 4	1810 825	12570 6120	130 140	180 200
850	855	1000	995	120	4	885	6770	220	314
880	880	1020	1020	86	5	840	6620	284	406
980	985	1120	1115	120	5	940	7880	200	284
1035	1035	1300	1300	96.8	6	823	1170	160	260
1060	1065	1250	1245	115	5	940	1240	140	200
1095	1095	1205	1205	55	3	377	2708	353	504
1180	1181	1280	1280	80	2.1	738	7680	150	220
1720	1721.2	1880	1880	80	2.5	988	12243	180	258
2860	2860	3140	3140	210	9.5	2434	42494	28	40
3000	3000	3250	3250	140	3	1612	29858	53	76

Bearing Designations		Minimum Load Constant <i>A</i>	Mounting Dimensions			Mass
Present	Original		<i>d</i> _a	<i>D</i> _a	<i>r</i> _{max}	
			mm			kg
	9089/708		846	812	6	190
572/710	70082/710	4.4	846	814	5	199.4
592/710	90082/710	4.4	846	814	5	284
591/750V	97081/750	6.21	838	812	3	100
591/750	90081/750	4.9	838	812	3	111
517/780	87/780	6.069	868	842	3	129
512/800			947	913	6	516
517/800			873	847	3	113
511/850	81/850	6.77	938	912	3	173
LY-5004		6.62	963	937	4	114
517/980	87/980	7.88	1063	1037	4	185
	9089/1035		1180	1154	5	311
591/1060	97081/1060	1.24	1168	1142	4	249
517/1095/HG2	7089/1095G2	2.709	1158	1142	2.5	68.5
510/1080	10089/1180	420	1238	1222	2	108
517/1720V	7089/1720	12.24	1808	1792	2	200
517/2860V	8089/2860	42.494	3020	2980	9	1821
517/3000V	87/3000	29.959	3132	3118	3.5	1116



Taper Roller Bearings

double-direction thrust ball bearings with flat back face

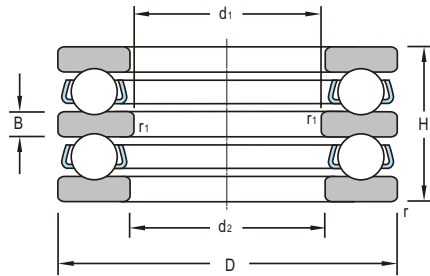

d 350~1420mm

Boundary Dimensions							Basic Load Ratings		Limiting Speeds	
d_1	d_2	D	H	B	r_{min}	r_{1min}	Dynamic C	Static C_0	Grease	Oil
mm							kN		r/min	
350	400.4	440	70	36	1.5	1.5				
865	940	1030	110	28	2.1	1.1	796	4272	280	400
845	950.8	1030	120	28	2.1	1.1	796	4272	260	370
		1030	110	28	2.1	1.1	796	4272	280	400
1049.5	1050	1250	220	77	5	3	1223	9989	99	142
1070	1181	1280	145	35	2.5	1.1	1192	7680	150	220
1420	1520	1720	270	61	7.5	7.5	2616	20520	51	73

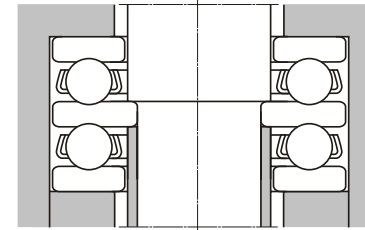

Bearing Designations		Mass
Present	Original	
		kg
	9038980	21.7
527/940	389/940	135
527/950.8	387/950	144
527/950.8YB2	388/950	136
2327/1049/YA	2687/1049	408
527/1181	389/1181	243
527/1520	387/1520	693

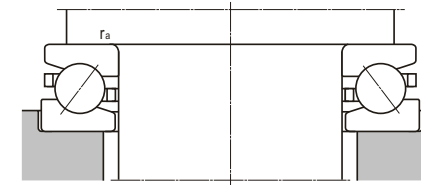
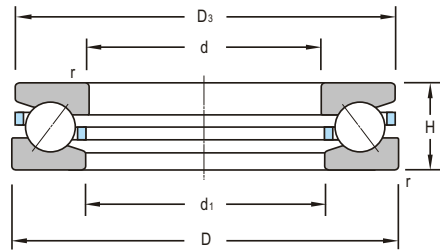

d 320~950mm

Boundary Dimensions							Basic Load Ratings		Limiting Speeds	
d	d ₁	D	D ₃	H	r _{min}	a	Dynamic C	Static C ₀	Grease	Oil
mm							kN		r/min	
320	335	400	385	48	3	60°	260	1115	830	1100
330	345	410	380	45	2	60°	111	607	600	900
380	410	470	440	50	2	60°	177	602	500	730
420	430	500	490	48	2	60°	260	1440	830	1100
	462	580	538	73	5	45°	330	2010	700	980
440	458	540	522	60	2.1	45°	380	1980	660	950
500	530	600	570	60	2.1	60°	322	1956	660	950
520	545	620	596	60	5	60°	440	2430	660	950
530	590	710	650	109	5	60°	695	4320	350	500
	550	710	690	109	5	60°	780	4250	350	500
560	620	740	680	89	6	45°	805	3432	400	570
562	580	632	612	40	1.5	60°	143	500	300	440
600	635	710	675	67	4	60°	380	2484	510	720
610	700	790	735	89	4.5	45°	839	3648	380	540
620	665	780	735	102	3.5	45°	776	3588	340	490
	640	700	680	50	1.5	60°	311	1314	260	380
650	720	880	800	140	6	60°	1105	7692	260	370
670	740	900	830	140	6	45°	1260	6084	250	360
750	780	900	870	90	4	60°	587	4620	340	480
800	840	950	910	120	4	60°	850	6710	200	240
	870	1060	990	155	7.5	60°	1145	8868	180	250
810	880	1030	960	110	7.5	45°	780	4080	280	400
950	1040	1250	1160	180	7.5	45°	1500	9168	120	170

Bearing Designations		Minimum Load Constant A	Mass
Present	Original		
			kg
569164	9168164	1.115	12.1
569164/YB2	9168764K	0.607	10.5
569176/YB2	9168776K	0.602	15.8
569184	9168184	3.9	15.9
567284	7168284	2.01	51
569188	9168188	1.98	25.5
5691/500	91681/500	1.956	25.3
5617/520	1687/520	2.4	29.7
5692/530	91682/530	4.02	93.9
5692/530/YB2	91682/530K		108
5617/560	1687/560	3.342	77
5617/562	1688/562	0.5	12.2
5691/600	91681/600	12	37.6
5617/610	1687/610	3.648	86
5617/620	1687/620	3.588	95.2
1688/620	5617/620	1.314	19.8
5617/650	1687/650	7.092	194
5692/670	91682/670	53	206
5691/750	91681/750	40	94.4
5611/800	1681/800	6.71	140
5692/800	91682/800	150	293
5617/810	1687/810	150	176
5691/950	91682/950	60	432

Thrust Roller Bearings

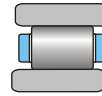

Cylindrical Roller Thrust Bearings

..... 393

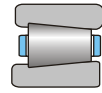

Taper Roller Thrust Bearings

..... 399



Spherical Roller Thrust Bearings

..... 401





Thrust Roller Bearings

Most of LYC's thrust roller bearings are separable, which make it very convenient to mount and dismount. This type of bearings has high rigidity and takes up little space, so it could carry heavier axial load and a certain amount of impact loads. They are mainly used in applications where the load carrying capacity of thrust ball bearing is inadequate.

LYC's thrust roller bearings are divided into cylindrical roller thrust bearings, taper roller thrust bearings, spherical roller thrust bearings, and needle roller thrust bearings by different structures.

Cylindrical Roller Thrust Bearings

LYC's cylindrical roller thrust bearings are divided into bearings of single row and double row. Single row cylindrical roller thrust bearings can carry axial load in one direction and limit axial displacement in one direction. Double-row cylindrical roller thrust bearings can carry axial load in both directions and limit axial displacements in both directions.

Taper Roller Thrust Bearings

LYC's taper roller thrust bearings have tapered inner raceway, outer raceway, and rolling elements. The extension lines of these intersect at one point of the shaft axis, which will make dynamic friction less compared with other types of thrust roller bearings.

Any angular error between axial and bearing block of taper roller thrust bearings is not allowed.

Needle Roller Thrust Bearing

The performance of LYC's needle roller thrust bearings is similar to that of cylindrical roller thrust bearings. Compared with cylindrical roller thrust bearings, the needle roller thrust bearings are with smaller axial dimension and have a high load carrying capacity. However, the friction is larger as the speed is slow because of the long length of needle rollers.

According to the number of rows, the needle roller thrust bearing is divided into single direction and double-direction.

Single direction needle roller thrust bearings can carry axial load in one direction and limit unidirectional axial displacements.

The needle roller thrust bearing does not allow any

angular error when mounting.

LYC can also design thrust roller bearings with other structures, such as double-row cylindrical roller thrust bearings, thrust roller bearings with outer covers or flat washers, cylindrical roller thrust bearings without rings etc. All types cannot be listed in this catalogue. If customers have additional requirements, please consult LYC technical department.

Cage

Cages for thrust roller bearings are supplied by LYC, these are pressed steel cages, machined solid cages, glass fabric reinforced polyamide 66 cages, and etc. Machined solid cages are mainly made of brass, bronze, various light alloys and phenolic resin. Cages of different material are identified by a suffix. Further details can be found in LYC catalogue "Bearing Material".

Minimum Load

In order to keep bearings working in a good condition, a minimum load must be imposed on bearings, particularly on bearings working at high speeds, high accelerations, or with the load direction changing frequently, because under these working conditions, inertial force of balls and cage and lubricant friction will have bad influence on the rotation of bearings, and detrimental sliding movement may be caused.

The minimum load of a thrust roller bearing can be obtained from

Cylindrical roller thrust bearings

$$F_{min} = 0.0005C_0 + A \left(\frac{n}{1000} \right)^2 \text{ kN}$$

Spherical roller thrust bearing

$$F_{min} = 1.8Fr + A \left(\frac{n}{1000} \right)^2 \text{ kN}$$

where

A - Minimum load constant, see bearing dimension tables.

n - Speed, r/min

Fr - Radial load (when combined load), kN

C₀ - Basic static load rating, kN

When bearings are started at low ambient temperatures or in the condition where the viscosity of lubricant is very high, a larger minimum load is required. Usually, the weight of the bearing supporting parts plus the load on the bearing have been over the minimum load. If the

weight cannot be up to the minimum load, then extra radial load must be imposed on this type of bearing in order to meet the requirement of minimum load. The requirement can be met through preloading in axial with springs.

Dimension, Tolerance

The boundary dimension of the LYC's standard thrust roller bearing is according to GB/T273.2 <Rolling Bearing, Thrust Bearing, and Boundary Dimension General Specification>, GB/T4663 <Rolling Bearing, Cylindrical Roller Thrust Bearing, and Boundary Dimension>, GB/T5859 <Rolling Bearing, Spherical Roller Thrust Bearing, and Boundary Dimension>.

The tolerance of LYC's standard thrust roller bearing is according to GB/T307.4 <Rolling Bearing, Thrust Bearing, and Tolerance>, JB/T7750 <Rolling Bearing, Spherical Roller Thrust Bearing, and Tolerance>.

Usually, the dimensional tolerance of LYC's standard taper roller bearing is the normal grade P0. If customers have other special requirements on dimension, tolerance, and clearance, then LYC have the ability to supply the corresponding products, including non-standard products.

Equivalent Dynamic Load

The equivalent dynamic load of thrust roller bearings can be calculated according to the following

$$\begin{aligned} \text{when } \alpha = 90^\circ & \quad P = Fa \\ \text{when } \alpha \neq 90^\circ & \quad P = XFr + YFa \end{aligned}$$

Single Direction Bearing:

$$\begin{aligned} Fa/Fr > e & \quad X = \tan \alpha \quad Y = 1 \\ & \quad e = 1.5 \tan \alpha \end{aligned}$$

Double-direction bearing

$$\begin{aligned} Fa/Fr \leq e & \quad X = 1.5 \tan \alpha \quad Y = 0.67 \\ & \quad e = 1.5 \tan \alpha \end{aligned}$$

$$\begin{aligned} Fa/Fr > e & \quad X = \tan \alpha \quad Y = 1 \\ & \quad e = 1.5 \tan \alpha \end{aligned}$$

Equivalent Static Load

The equivalent static load of thrust roller bearings can be calculated from

$$\text{when } \alpha = 90^\circ \quad P_0 = Fa$$

$$\text{when } \alpha \neq 90^\circ \quad P_0 = Fa + 2.3Fr \cdot \tan \alpha$$

where

Fa - Radial load, N

Fr - Axial load, N

α - Contact angle

X - Radial load factor

Y - Axial load factor

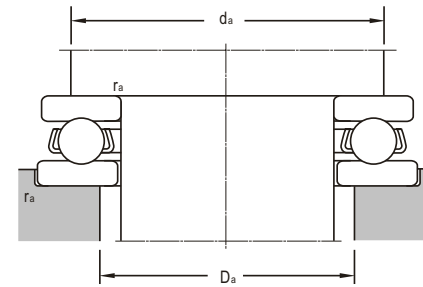
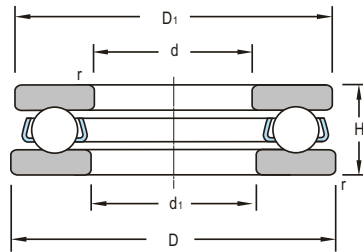

d 25~75mm

Boundary Dimensions						Basic Load Ratings		Limiting Speeds	
d	d ₁	D	D ₁	H	r _{min}	Dynamic C	Static C ₀	Grease	Oil
mm						kN		r/min	
25	25.2	40.5	40.5	7	0.3	13.8	66	4000	5500
34.925	37	79	79	15.875	1	76.8	316.8	2500	3400
35	35.2 35	52 52	52 52	8 18.5	0.6 1	18.1	95.74	3400	4500
40	40.2 40.2 40.2 42	60 68 90 78	60 68 90 78	13 19 16 22	0.6 1 1.1 1	38 83 92.9 91.1	118 255 400 285	1700 1400 2400 2000	2400 1900 3100 4000
45	45.2 45	110 80	110 80	19 60	1.1 1	150	619.5	1900	2600
50	50.2 50	78 110	78 110	22 82	1 1.1	91.5	300	1200	1700
55	55.2 57 57	78 90 105	78 90 105	16 25 30	0.6 1 1.1	69.5 116 145	285 365 564	1400 950 1200	1900 1400 1600
60	60 60 60.2 62 62 62 62	100 120 138 85 95 110 130	100 120 138 85 95 110 130	12 82 22 17 26 30 32	1 1.1 2 1 1 1.1 1.5	91.4	372		
65	65 65.2 67 70	90 90 100 165	90 90 100 165	26.4 18 27 25	1.5 1 1 2	83 140	320 490	1200 1200	1700 1700
70	72	95	95	18	1	81.9	254	1200	1700
72	72	108	102	13	1.5				
75	77 77	100 110	100 110	19 27	1 1	75.5 125	266 440	1100 850	1600 1200

Bearing Designations		Minimum Load Constant A	Mounting Dimensions			Mass
Present	Original		d _a	D _a	r _{max}	
			mm			kg
81705	589705	0.00031	39	26	0.3	0.038
817/34.925	549707	0.0083	75	38	1	0.441
87107	7009107 89707	0.00057	51 51	36 36	0.6 1	0.0625 0.173
81108	9108	0.0011	56	44	0.6	0.146
81208	9208	0.0051	63	45	1	0.32
81708	559708	0.0073	85	44	1.1	0.497
89308M		0.009	76	44	1	0.526
81709	559709 459709	0.0077	106 68	47 46	1.1 1	0.94 1.21
81210	9210 495710	0.0073	75 91	53 54	1 1.1	0.43 3.59
81111	9111	0.0066	77	56	0.6	0.27
81211	9211	0.011	85	59	1	0.708
89311	954311	0.019	102	59	1.1	1.38
KOW-87212X3			124	63	1	0.404
81712	459712 559712		102 134	64 65	1.1 2	4.41 1.18
81112	9112	0.0073	82	62	1	0.338
81212	9212		91	64	1	0.792
89312M		0.023	107	65	1	1.37
87412	7559412	0.06	124	65	1.5	2.45
81113	89713 9113	0.0083	87 87	67 67	1.5 1	0.63 0.381
81213	9213	0.019	96	69	1	0.874
81714	559714		157	72	2	2.6
81114	9214	0.0096	92	72	1	0.403
81814	559814		99	74	1.5	
81115	9115	0.0068	97	78	1	0.455
81215	9215	0.015	106	79	1	0.979

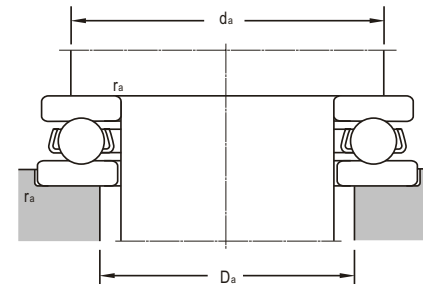
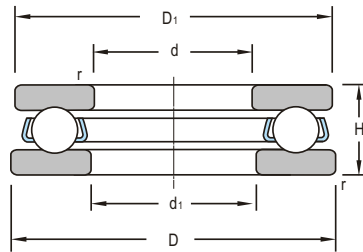

d 75~150mm

Boundary Dimensions						Basic Load Ratings		Limiting Speeds	
d	d ₁	D	D ₁	H	r _{min}	Dynamic C	Static C ₀	Grease	Oil
mm						kN		r/min	
75	77	135	135	36	1.5	218	920	1000	2400
80	80.2	150	150	26	1.5	238	1056	1400	1900
	80.2	150	150	26	2.5				
	82	105	105	19	1	76.5	134	1000	1500
	82	115	115	28	1	160	270	850	1200
85	85.2	110	110	19	1	76.5	310	1000	1500
	88	125	125	31	1	153	550	800	1100
	88	150	150	39	1.5	286	1200	900	1200
	88	150	150	39	1.5	257	1100	1100	2200
90	90.2	120	120	22	1	104	415	900	1300
	90.2	160	160	26	1.5	250	1210	1300	1800
100			135	11	1	77.6	530	1800	2500
	100.2	190	190	39	1.5	451	2090	1000	1400
	100.2	135	135	25	1	152	544	850	1200
	103	150	150	38	1.1	214	830	800	1100
110	103	170	170	42	1.5	327	1520	760	1100
	110.2	200	200	39	2.1	459	2194	990	1300
	110.2	200	200	26	2	460	2180		
	111	230	230	60	3	634	2642	720	960
120	112	145	145	25	1	153	280	800	1100
	113	160	160	38	1.1	244	827	630	850
	100	215	215	30	1.1	451	2471	850	1200
130	120.2	155	155	25	1	146	680	950	1400
	123	170	170	39	1.1	258	918	600	800
	123	210	210	54	2.1	555	1876		
150			170	14	1	113	825	1400	1800
	130.2	225	187	30	2.1	446	2180		
	133	190	187	45	1.5	344	1250	670	900
150			188	21.5	1	246	1174	1000	1300
	150.3	300	300	35	2.1	698	4330	840	1100
	152	190	188	31	1	253	1230	630	850
	153	230	227	50	3	553	2370	800	1100

Bearing Designations		Minimum Load Constant A	Mounting Dimensions			Mass
Present	Original		d _a	D _a	r _{max}	
			mm			kg
89315M		0.042	132	83	1.5	2.51
81716	9716	0.032	143	82	1.5	2.06
81716L	9716L		143			2.06
81116	9116	0.0073	102	83	1	0.4
81216	9216	0.03	112	84	1	0.9
82716	59716	0.044	130	92	0.6	3.28
81117	9117	0.0077	108	87	1	0.52
81217	9217	0.024	119	90	1	1.44
89317	9549317	0.054	144	91	1.5	3.35
89317M		0.054	147	93	1.5	3.29
81118	9118	0.014	117	93	1	0.797
81718	9718	0.039	154	96	1.5	2.25
KIW-87120	7789120	0.028	131	104		0.517
81720	9720	0.06	182	105		5.11
81120	9220	0.028	131	104	1	1.19
81220	9220	0.054	142	107	1	2.58
89320	9549320	0.074	163	108	1.5	4.49
81722	9722	0.075	192	115	2.1	5.43
40W-87322X3			192	115	2	3.7
89422 X2	549822	0.3	220	116	3	13.7
81122	9122	0.32	141	114	1	1.1
81222	9222	0.067	152	117	1	2.78
81724	559724	0.1	206	125	1.1	5.03
81124	9124	0.037	151	124	1	1.36
81224	9224	0.074	162	127	1	3.08
89324	9549324		202	127	2.1	9.37
KIW-89126 X2	799726	0.049	163	135	1	0.949
KOW-8726X2		5.52	181	135	2.1	5.52
81226	9226	0.13	181	137	1.5	4.59
KIW-81130	209130	0.065	182	156	1	1.54
87430 X2	569730	0.45	288	156	2.1	11.3
81130	9130	0.065	185	155	1	2.3
81730	9830	0.35	220	160	3	8.22

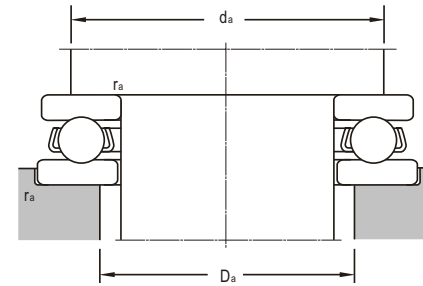
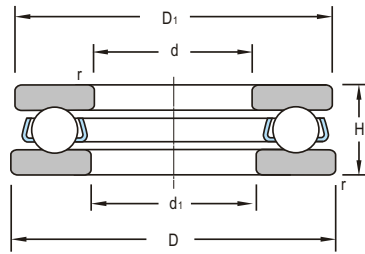

d 150~1320mm

Boundary Dimensions						Basic Load Ratings		Limiting Speeds	
d	d ₁	D	D ₁	H	r _{min}	Dynamic C	Static C ₀	Grease	Oil
mm						kN		r/min	
150	153	215	212	50	1.5	459	1615	480	630
240	285	445		95	4	1210	5943	360	480
	300	540		145	6	2770	12917	230	300
280	285	440	435	95	5	2230	10200	260	310
420	424	495	500	65	2	900	2600	240	340
	464	560	555	80	2.1	1030	6150	200	300
	461.5	580	580	102	4	1580	8580		
500	505	670	665	135	5	3400	17600	140	190
530	532	710	708	82	5	2280	17840	220	290
560	565	750	745	150	5	3900	20800	120	170
600	602	860	860	125	6	3870	12980	130	180
610	610	710	710	65	4	1080	7300		
630	634	750	745	95	3	2180	13700	220	450
670	672	900	900	103	6	3530	26503	160	200
710	714	850	848	63	4	1440	13657	240	300
800	800	950	950	90	4	1360	9440	160	200
850	855	1000	995	67	4	1864	17480	200	260
900	902	1180	1180	125	7.5	5300	50459	100	130
1060	1065	1400	1400	155	9.5	8950	79388	87	110
1180	1180	1325		88.5	3	4430	21700	100	150
	1185	1400	1395	100	6	4430	48664	110	140
1320	1325	1700	1700	175	9.5	10300	105400	67	90

Bearing Designations		Minimum Load Constant A	Mounting Dimensions			Mass
Present	Original		d _a	D _a	r _{max}	
			mm			kg
81230	9230	0.28	211	158	1.5	6.45
81757 DH	809757	4	428	296	4	60.4
	89460 DH	10	520	312	6	161
89356			421	299	4	60.8
81184		2.8	493	433	2	25.6
81192 LY-8008		5.7	553	479	2	42.6
			558	480	4	71.8
812/500	92/500	25	661	540	4	153
872/530	75492/530	23	689	551	5	96.6
812/560	92/560	35	741	611	4	198
817/600	5497/600	23	850	620	6	264
817/610M/P4YB5		23.1	698	622	3	51
811/630M		91.2	740	640	2.5	83.7
872/670	75492/670	30	895	685	6	198
871/710	75491/710	27	843	728	4	79
891/800	90091/800	32	944	810	4	105
871/850	75491/850	32	989	862	4	97.1
972/900	75492/900	46	1173	908	7.5	386
872/1060	75492/1060	50	1392	1072	9.5	689
817/1180 DH	97/1180	25	1317	1188	3	173
	871/1180	35	1389	1190	6	311
872/1320	75492/1320	56	1690	1330	9.5	105

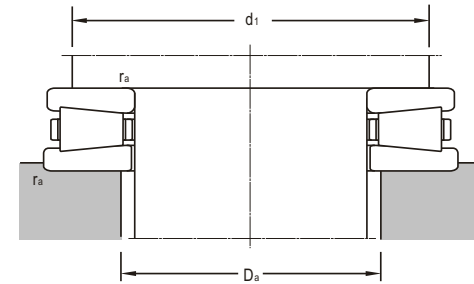
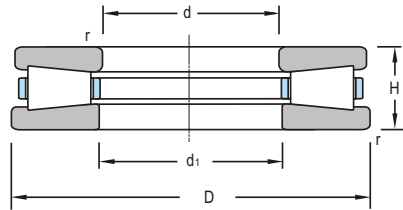

d 84.925~1290mm

Boundary Dimensions					Basic Load Ratings		Limiting Speeds	
<i>d</i>	<i>d</i> ₁	<i>D</i>	<i>H</i>	<i>r</i> _{min}	Dynamic <i>C</i>	Static <i>C</i> ₀	Grease	Oil
mm					kN		r/min	
84.925	84.925	76.2	15.875	1.5	89	301		
180	180.3	360	109	5	1920	6700	300	500
200	200.3	400	122	5	1720	7226	200	300
210	210.3	460	122	7.5	2870	14450	290	390
	210.3	460	150	7.5	2870	14450	290	390
240		540	127	7.5	5100	28760	250	340
260	260.3	480	132	6	2558	11360	160	220
270	270.3	550	130	6	4080	20940	240	330
280	280.3	520	145	6	2950	13350	140	190
320	320.4	580	155	7.5	3740	17537	110	160
	320.4	580	155	7.5	4260	16400	110	160
380	380.4	670	175	7.5	4710	22870	85	120
1290	1291	1550	134	6	6970	55950	95	120

Bearing Designations		Minimum Load Constant <i>A</i>	Mounting Dimensions			Mass kg
Present	Original		<i>d</i> ₀	<i>D</i> ₀	<i>r</i> _{max}	
			mm			
T135			74	36	1.5	0.387
99436M/P6		0.25	280	260	4	59.6
99440	9019440		386	206	5	75
91742	19742	0.25	454	216	7.5	107
91742 DS	219742	0.25	454	216	7.5	134
91748/YA	219748	0.3	534	247	7.5	157
99452	9019452	0.35	472	268	6	111
91754	19954	0.35	546	278	6	164
99456	9019456	0.35	516	288	6	143
99464	9019464	0.38	576	324	7.5	185
99464M		0.38	576	324	7.5	798
99476	9019476	0.56	664	388	7.5	274
917/1290	197/1290	1.6	1546	1296	6	495

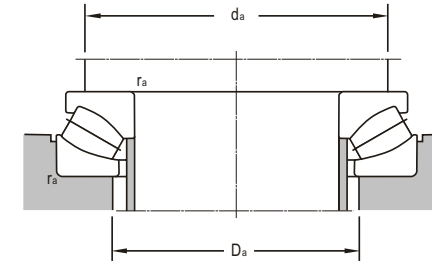
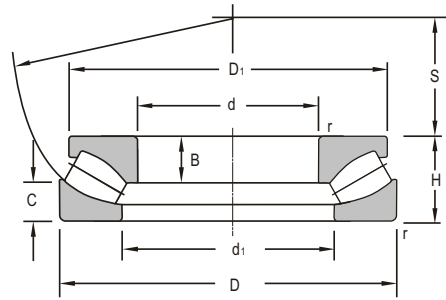

d 90~220mm

Boundary Dimensions									Basic Load Ratings		Limiting Speeds	
d	d ₁	D	D ₁	B	C	H	S	r _{min}	Dynamic C	Static C ₀	Grease	Oil
mm									kN		r/min	
90	128	190	169.6	22	29	60	56	2.1	624	1750	1260	1800
100	129	170	153	15	20.8	42	58	1.5	410	1280	1120	1600
	140	210	187.6	24	32	67	62	3	762	2170	760	1000
110	135	190	175	30	24	48	64	2	347	970	1200	1800
	150	230	195	43	35	73	69	3	545	1479	800	1200
	150	230	195	43	35	73	69	3	545	1479	800	1200
	155	230	200	26	34.5	73	69	3	950	2790	800	1200
120	156.5	210	192.7	18	26.5	54	70	2.1	607	1940	1120	1600
130	184	270	240.6	31	41	85	81	4	1210	3570	800	1200
140	181	240	221.8	20	29	60	82	2.1	760	2530	980	1400
150	185	250	220	36	31	60	87	2.1	525	1670	850	1300
	207.6	300	270.5	32	43.5	90	92	4	1240	4390	770	1100
160	200	270	240	45	32	67	92	3	610	2240	800	1200
	218	320	289.5	34	46	95	99	5	1440	5050	760	1000
170	216	280	255	23	32	67	96	3	954	3220	900	1400
	236	340	300	62	52	103	104	5	1400	4120	650	950
	235	340	308.8	37	50	103	104	5	1820	5900	650	950
180	225	300	270	46	36	73	103	3	790	2713	700	1000
	230	300	276.8	25	34.5	73	103	3	967	3864	700	1000
	230	300	276.8	25	34.5	73	103	3	967	3864	700	1000
	250	360	325.5	39	53	109	110	5	1770	6460	630	900
190	224	270	250	30	24	48	110	2	420	1746	950	1500
	226	270	253.3	14	25.5	48	103	2	2100	2260	950	1500
	268	380	340	41	53.5	115	117	5	2070	7594	430	600
200	257	340	306.5	54	41	85	116	4	1450	5080	650	900
	257	340	306.5	29	41	85	116	4	1420	4930	800	1200
	270	400	340	62	62	122	122	5	1740	6054	430	600
	278	400	360	43	59	122	122	5	2760	9000	600	800
220	254	300	278	29	26	48	117	2	504	1932	438	1300

Bearing Designations		Minimum Load Constant A	Mounting Dimensions			Mass
Present	Original		d _a	D _a	r _{max}	
			mm			kg
29418	9039320	0.41	135	158	2	7.78
29320		0.166	132	148	1.5	3.66
29420	9069322	0.64	150	175	2.5	10.5
	9069422					
9069322	9069422Y	0.138	145	165	2	5.46
9069422		0.393	165	192	2.5	12.8
9069422Y		0.393				12.8
29422/HE		0.393	165	192	2.5	13.4
29324		0.44	160	182	2	7.48
29428		1.7	195	227	3	21.9
29328	9069330	0.8	185	208	2	10.6
9069330		0.54	195	220	2	10.2
29430	9069332	2.6	220	253	3	28.2
9069332		0.736	210	236	2.5	13.5
29432		3.2	230	271	4	34.3
29334M/P6		1.9	220	245	2.5	15.1
9069434		4.1	245	288	4	38.8
29434	9069336	4.3	245	288	4	41.9
9069336		0.883	235	263	2.5	18.3
29336/P6		1.7	235	263	2.5	19.5
29336		1.7	235	263	2.5	19.4
29436	9069238	5.4	260	305	4	49.2
9069238	9039438	0.442	220	244	2	8
29238			220	244	2	7.87
29438	9069440	6.228	275	322	4	56.4
	9039440E					
LY-Z089		3	218	322	3	28.8
29340		4.1	265	295	3	28.7
9069440		5.685	290	338	4	60.6
29440E	9069244	5.978	290	338	4	71.1
	9069344					
9069244		0.491	260	277	2	11.2

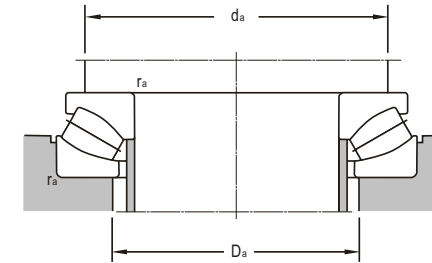
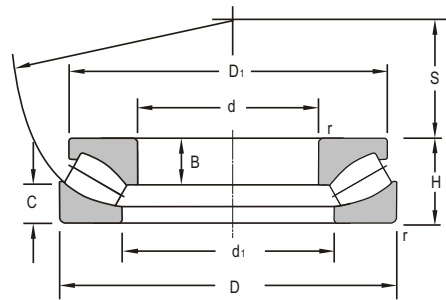

d 220~360mm

Boundary Dimensions									Basic Load Ratings		Limiting Speeds	
d	d ₁	D	D ₁	B	C	H	S	r _{min}	Dynamic C	Static C ₀	Grease	Oil
mm									kN		r/min	
220	254	300	283	15	24	48	117	2	654	2750	438	1300
	270	360	320	52	44	85	125	4	970	3769	560	800
	278	360	332.9	29	41	85	125	4	1500	5470	560	800
	290	420	360	76	58	122	132	6	1830	6624	400	560
	301.5	420	378.1	79	57	122	132	6	2260	8470	390	550
240	280	340	323.9	19	31.2	60	130	2.1	800	3450	770	1100
	290	380	340	52	44	85	135	4	1320	4251	560	800
	310	440	380	62	62	122	142	6	1920	7158	380	530
260	295	360	330	38	30	60	139	2.1	645	2877	700	1000
	302	360	340.8	19	30	60	139	2.1	944	4000	700	1000
	315	420	370	60	46	95	148	5	1390	5793	480	670
	327	420	390	32	45	95	148	5	2220	8300	600	800
	335	480	415	80	66	132	154	6	2120	8118	340	480
	346	480	434.9	48	63	132	154	6	2730	10800	450	600
	353	480	429	83	64	132	154	6	3220	11200	400	560
280	323	380	360.4	19	30	60	150	2.1	852	4330	700	1000
	335	440	390	62	46	95	158	5	1410	5980	450	630
	348	440	409.8	32	46	95	158	5	1980	7710	650	870
	348	440	409.8	61	46	95	158	5	2040	8010	650	970
	365	520	450	75	72	145	166	6	2550	9828	300	480
	372	520	475.6	52	70	145	166	6	3800	13450	400	550
300	365	480	425	58	52	109	168	5	1870	7640	400	560
320	385	500	445	68	55	109	180	5	2030	7915	380	530
	369	440	413	21	38	73	172	3	1300	5610	800	1100
	410	580	500	95	75	155	191	7.5	2930	11660	240	360
	424	580	528.5	55	74	155	191	7.5	3910	16180	350	500
	424	580	528.5	55	74	170	176	7.5	3910	16180	350	500
	424	580	530	70	74	170	176	7.5	4520	16300	350	500
340	390.5	460	436.5	21	37	73	183	3	1410	6440	800	1100
	410	540	480	74	62	122	192	5	2710	11000	420	600
	462	620	590	61	82	170	201	7.5	4550	17480	220	320
360	442	560	523.1	41	59.5	122	202	5	2744	12707	550	700
	460	640	555	87	85	170	210	7.5	3790	15440	190	300

Bearing Designations		Minimum Load Constant A	Mounting Dimensions			Mass
Present	Original		d _a	D _a	r _{max}	
			mm			kg
LY-Z092		0.491	260	277	2	9.04
9069344		2.059	285	316	3	32.5
29344		3.8	285	316	3	31.9
9069444	9069444	6.665	310	360	5	68.7
29444		6.7	310	360	5	71.3
29248E	9039248E	1.483	285	311	2	19.3
9069348	9069348	2.556	300	337	3	33.8
9069448	9069448	7.645	330	381	5	70
9069252	9069252	1.128	305	331	2	16.9
29252		1.5	305	331	2	17.1
9069352	9069352	4.705	330	372	4	45.6
29352 E	9039352E	6.5	330	372	4	53.6
9069452	9069452	9.81	360	419	5	91.8
29452		16	360	419	5	99.2
29452B		21	360	419	5	95.2
29256		1.7	325	351	2	18.1
9069356	9069356	5.097	350	394	4	48.4
29356		7	350	394	4	50.2
LY-Z088		7	350	394	4	50.7
9069456	9069456	14.5	390	446	5	115
29456		23	390	446	5	130
9069360	9069360	8.527	380	429	4	61.4
9069364	9069364	8.919	400	449	4	73.4
29264		2.8	375	406	2.5	29.4
9069464	9069464	20.1	435	507	6	171
29464		35	435	507	6	168
29464/P6		35	435	507	6	168
29464X2		35	435	507	6	185
29268		3.1	395	427	2.5	32.3
9069368	9069368	11	430	484	4	94.9
29468	9039468	30.19	465	541	6	226
29372		15	450	504	4	104
9069472	9069472	35.38	485	560	6	199

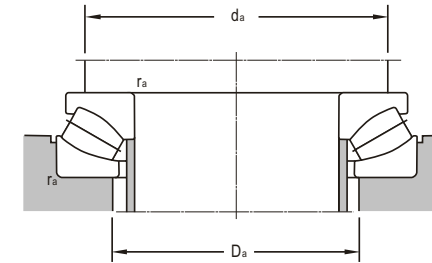
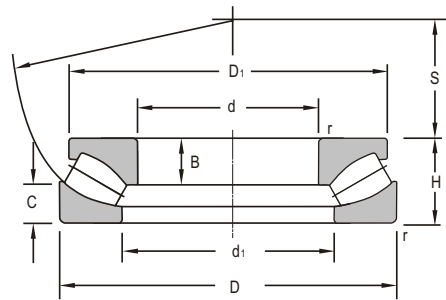

d 380--750mm

Boundary Dimensions									Basic Load Ratings		Limiting Speeds	
d	d ₁	D	D ₁	B	C	H	S	r _{min}	Dynamic C	Static C ₀	Grease	Oil
mm									kN		r/min	
380	439	520	497	27	41.8	85	202	4	1460	6800	550	750
400	450	540	500	55	42	85	212	4	1260	7060	430	600
	475	620	555	81	65	132	225	6	2860	12050	260	380
	510	710	620	113	93	185	236	7.5	4820	19060	260	380
420	514.5	650	608.3	48	68.5	140	235	6	3660	17600	400	500
440	508	600	570.2	30	48	95	235	5	2350	11100	550	750
	540	680	626	48	70.5	145	245	6	4440	18600	500	720
	575	780	710	74	100	206	260	9.5	7310	27700	500	700
460	527	620	690.8	30	47	95	245	5	2440	11800	430	600
	567	710	685	51	72	150	257	6	4310	19000	320	450
480	540	650	600	65	50	103	259	5	1950	10500	340	480
500	560	670	620	60	50	103	268	5	1950	10540	320	450
	569	670	637.3	33	52	103	268	5	2590	13000	400	560
	590	750	675	94	74	150	280	6	3520	16900	180	280
	590	750	675	94	74	150	280	6	3520	16900	180	280
	630	870	760	140	110	224	290	9.5	6290	27340	120	180
	652.5	870	794.5	81	107.5	224	290	9.5	7850	34600	200	300
530	601.5	710	681.2	39	57	109	288	5	3220	16400	400	550
	690	920	841.5	85	110.4	236	309	9.5	9000	41950	120	160
	700	920	840	145	116	236	309	9.5	8386	32630	120	160
560	625	750	695	72	58	115	300	5	2430	13320	260	380
600	688	800	780	39	65	122	321	5	3420	20500	240	340
	750	1030	900	156	130	258	360	12	9626	37580	100	130
630	705	850	785	84	64	132	338	6	3270	17760	190	300
	728	850	830	42	67	132	338	6	4634	24450	190	300
670	750	900	830	86	70	140	365	6	3670	20280	180	280
710	915	1220	1131.8	113	150	308	415	15	15500	67400	120	160
750	935	1280	1120	195	155	315	450	15	14340	58590	80	100

Bearing Designations		Minimum Load Constant A	Mounting Dimensions			Mass
Present	Original		d _a	D _a	r _{max}	
			mm			kg
29276 E	9039276E	5.6	440	480	3	50
9069280	9069280	6.763	460	500	3	49
9069380	9069380	20.59	500	557	5	134
9069480	9069480	53.8	540	622	6	3.88
29384		26	525	585	5	161
29288		12	510	554	4	72.7
29388EM		42	550	600	5	180
29488		110	595	670	8	396
29292		12	530	575	4	81
29392	9039392	34	575	628	5	217
9069296	9069296	14.99	555	603	4	89.4
90692/500	90692/500	15	575	622	4	89.6
292/500		16	575	622	4	95.7
90693/500	90693/500	39.99	615	683	5	203
90693/500K	90693/500K	40	630	675	5	203
90694/500	90694/500	110.8	670	765	8	520
294/500		130	670	765	8	521
292/530		22	620	655	4	114
294/530 E	90394/530E	179.2	700	810	8	624
90694/530	90694/530	137.8	700	810	8	573
90692/560	90692/560	23.92	645	697	4	127
292/600	90392/600	37.04	690	744	4	172
90694/600	90694/600	223	800	900	10	700
90692/630	90692/630	42.73	730	789	5	188
292/630	90392/630	52.95	730	789	5	218
90692/670	90692/670	55.67	790	825	5	218
294/710		560	925	1073	12	1400
90694/750	90694/750	412.8	1000	1130	12	1309



Thrust Ball Bearings

spherical-roller

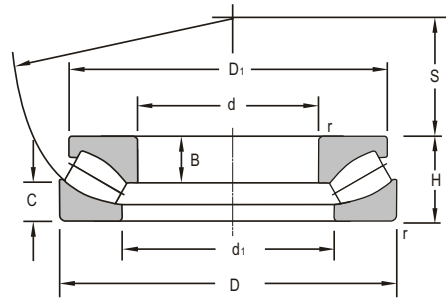

d 750~1620mm

Boundary Dimensions									Basic Load Ratings		Limiting Speeds	
<i>d</i>	<i>d</i> ₁	<i>D</i>	<i>D</i> ₁	<i>B</i>	<i>C</i>	<i>H</i>	<i>S</i>	<i>r</i> _{min}	Dynamic <i>C</i>	Static <i>C</i> ₀	Grease	Oil
mm									kN		r/min	
750	964	1280	1183	122	152	315	436	15	159000	70800	140	200
800	1034	1360	1310	120	165	335	462	15	2000	91000	130	180
1060	1180	1400	1300	128	103	206	566	12	10500	58500	120	160
	1200	1400	1325	66	103	206	566	9.5	10500	58200	120	160
	1349	1770	1615	192	207	426	610	15	32200	146000	100	150
1180	1330	1520	1452	83	101	206	625	9.5	9900	56900	110	160
1320	1380	1540	1510	87	72	175	1446	6	4050	50400	70	90
1620	1700	1860	1799	45	80	150	850	6	6150	48400	50	70

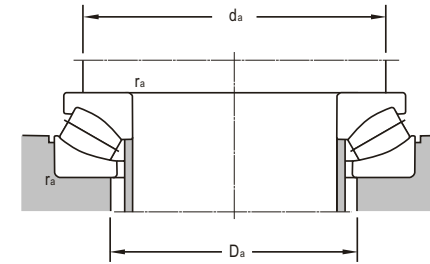

Bearing Designations		Minimum Load Constant <i>A</i>	Mounting Dimensions			Mass kg
Present	Original		<i>d</i> _a	<i>D</i> _a	<i>r</i> _{max}	
			mm			
294/750		590	1000	1130	12	1650
294/800		680	1080	1185	12	1870
906921/1060	90692/1060	300	1225	1290	8	824
292/1060EF		300	1225	1290	8	784
294/1060EF/HC			1360	1570	10	3973
292/1180EF			1270	1430	8	855
691/1320	691/1320	140	1430	1470	8	480
292/1620			1740	1780	10	552

Hub Unit, Redirection, Pump, Clutch Bearings

Hub Bearings	411
Redirection Bearings	414
Pump Bearings	415
Clutch Bearings	417



Hub Bearings

The main function of hub bearings is carrying load and guiding hub to rotate accurately. Hub bearings are very important components and they can carry both radial and axial loads. Hub bearing units are developed based on standard angular contact ball bearings and tapered roller bearings. It is light, compact and assembly well.

Hub bearings are widely used in automobiles.

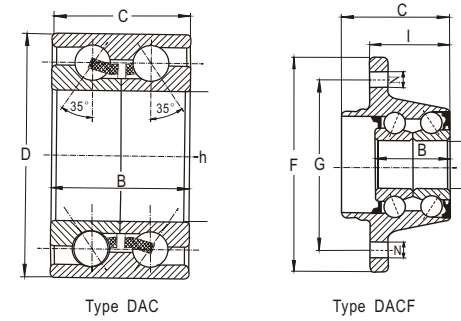

Bearing Designations	Boundary Dimensions			
	<i>d</i>	<i>D</i>	<i>B</i>	<i>C</i>
	mm			
DAC3006037	30	60	37	37
DAC300526	30	55	26	26
DAC3406237	34	62	37	37
DAC3406637	34	66	37	37
DAC3406437	34	64	37	37
DAC3506437	35	64	37	37
DAC3506535	35	65	35	35
DAC3506637	35	66	37	37
DAC3506837	35	68	37	37
DAC3506633	35	66	33	33
DAC3906837	39	68	37	37
DAC3507234	35	72	34	34
DAC3707237	37	72	37	37
DAC3807038	38	70	38	38
DAC3807450	38	74	50	50
DAC3906837	39	68	37	37
DAC3907237	39	72	37	37
DAC4007537	40	75	37	37
DAC4808030	40	80	30.2	30.2
DAC4008240	40	82	40	40
DAC4007237	40	72	37	37
DAC4207639	42	76	39	39
DAC4208439	42	84	39	39
DAC4207537	42	75	37	37
DAC4208237	42	82	37	37
DAC4208236	42	82	36	36
DAC4308237	43	82	37	37
DAC4508237	45	82	37	37

Bearing Designations	Boundary Dimensions						
	<i>D</i>	<i>F</i>	<i>B</i>	<i>C</i>	<i>G</i>	<i>N</i>	<i>I</i>
	mm						
DACF2714873	27	148	55	73	114.3	12.5	57.5
DACF3012679	30	126	59	79	100	14	62.5
DACF3013666	30	136	40	66	100	12.1	54.5
DACF3112061	31	120	40	61	100	12	42
DACF3513774	35	137	45	74	110	12	49
DACF3614071	36	140	50	71	114.3	14	57
DACF3713964	37	139	45	64	120	12	45

hub bearings
redirection bearings

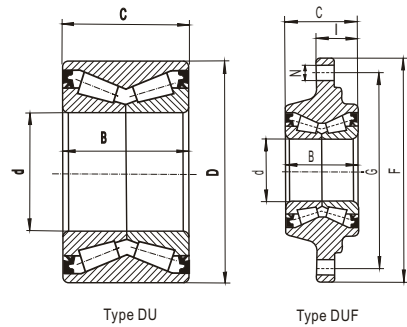

Type DU

Type DUF

Bearing Designations	Boundary Dimensions			
	<i>d</i>	<i>D</i>	<i>B</i>	<i>C</i>
	mm			
DU2505237	25	52	37	37
DU3506437	35	64	37	37
DU3906837	39	68	37	37
DU4207639	42	76	39	39
DU5008454	50	84	54	54

Bearing Designations	Boundary Dimensions						
	<i>D</i>	<i>F</i>	<i>B</i>	<i>C</i>	<i>G</i>	<i>N</i>	<i>I</i>
	mm						
DUF5515254	55	152	54	54	126	14	38.5
DUF5816762	58	167	62	62	140	14	41.2

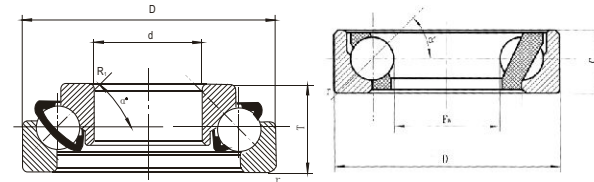

Type 560000

Type KOW-560000

Redirection Bearings

Because of the angle existing between the plate of ball center and the line of raceway contact point, the bearing can carry combined loads in radial and axial direction. In addition, the limited speeding is higher but loading capacity is less.

Bearing Designations	Boundary Dimensions				
	<i>d</i>	<i>D</i>	<i>T</i>	<i>r_s</i> min	<i>r_{1s}</i> min
	mm				
569304	20	47	16	1	1
567404X3	20	52	16	1	1.5
567404	20	52	15	1	1.5
569305	25	52	16	1.1	1
569305X2	25	52	15	1	1
567405X3	25	62	18	2	1
569306	30	60	18	1.1	2

Bearing Designations	Boundary Dimensions			
	<i>d</i>	<i>D</i>	<i>T</i>	<i>r_s</i> min
	mm			
KOW-5617/15.2	15.2	35	10.5	1.5
KOW-5617/19.8	19.8	38.1	7.9	1
KOW-5617/20.3TN1	20.3	44	12	1.5
KOW-5617/22.1TN1	22.1	48	13.5	1.5
KOW-5617/25.6	25.6	46	9	1
R7202BX1	15.2	38	11	0.6

Pump Bearings

Pump bearings are good at carrying capacity and stiffness, and have light weight, high rotating precision, mass flow, long working life, reasonable structures and perfect reliability. The radial clearance is existed in this bearing. The lubricant with higher dropping point as well as better viscosity is used. In order to make oil lossless, the seal rings have radial contact seals with bigger interference.

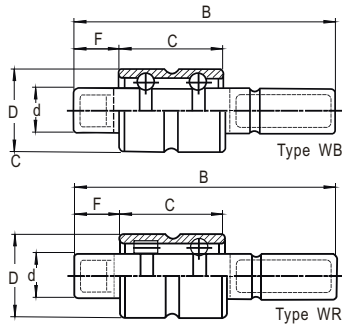

Bearing Designations	Boundary Dimensions				
	D	C	B	F	d
	mm				
WB1024081	24	31.5	81	19.5	10
WB1224065	24	33.38	65.41	16	12.038
WB1224084-1	24	33.38	83.57	16.39	12.738
WB1226090	26	39	89.5	16.5	12
WB1226093-1	26	39	92.5	16.5	12
WB1226114	26	39	113.5	17.5	12
WB1630068	30	38.89	68.4	25	15.918
WB1730071	30	23	71.2	13.5	17.2
WB1630087C	30	38.89	86.5	13.5	15.918
WB1630092	30	38.89	92	16.5	15.918
WB1630098C	30	38.89	98	16	15.918
WB1630119C	30	38.89	119.3	37.6	15.918
WB1630102-2	30	38.89	101.5	17.5	15.918
WB1630109	30	38.89	109	27.31	16
WB1630106	30	38.89	106	26.11	16
WB1630122-4	30	38.89	122.17	33.88	15.918
WB1630136-2	30	38.89	136.4	39.1	15.918
WB1835124C	35	46	124.5	26.5	18
WB1835128	35	46	128	30	18
WB1835128C	35	46	128	30	18
WB1938145-1	38.1	53.975	145.796	44.704	18.961
WB1740136	40	46	136	26	19
WB1840123	40	46	123	23	19
WR1630102C	30	38.89	101.5	17.5	15.918
WR1630129-1	30	38.89	128	25.61	16
WR1530114	30	38.89	114	19.8	15
WR1635124	35	39	124	30	17.5
WR1635112	35	39	112	42	17.5
WR2040105C	40	42	105	20.5	20
WR2042115	42	46	115.5	26.5	20
WR2552143C	52	56	143	36	25

Clutch Bearings

Clutch bearings belong to aligning bearings, this enable them to have capacity to reduce wearing, noise and temper rise caused by contacting with clapboard when rotating. They are with compact structure, small volume and light weight. Additionally, can work in good condition under inferior application.

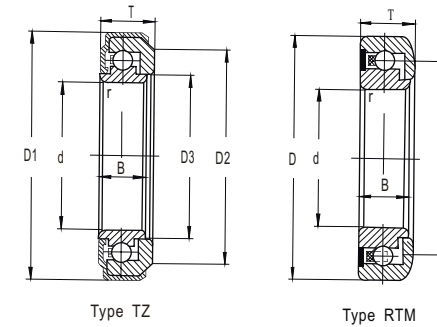

Bearing Designations	Boundary Dimensions						
	d	T	D _{1max}	D _{2min}	D ₃	B	r _{gmin}
	mm						
TZ3011	30	11	49	41	30.5	8.5	0.3
TZ3016	30	16	57	49	36	15.5	0.3
TZ3513	35	13	57	49	35.5	10.5	0.5
TZ3517	35	17	64	56	41	16.5	0.5
TZ4014	40	14	64	56	40.5	11	0.5
TZ4018	40	18	70	62	46	17	0.5
TZ4514	45	14	70	62	45.5	11	0.5
TZ4519	45	19	77	69	51	18	0.5
TZ5014	50	14	74	66	50.5	11	0.5
TZ5019	50	19	82	74	56	18	0.5
TZ5516	55	16	82	74	55.5	13	0.8
TZ5522	55	22	92	84	63	21	0.8
TZ6016	60	16	87	79	60.5	13	0.8
TZ6022	60	22	97	89	68	21	0.8
TZ6516	65	16	92	84	65.5	13	0.8
TZ6522	65	22	102	94	73	21	0.8
TZ7024	70	24	112	104	78	22.5	0.8
TZ7524	75	24	118	109	83	22.5	0.8
TZ8027	80	27	128	119	88	22.5	0.8

Bearing Designations	Boundary Dimensions						
	d	T	D _{1max}	D _{2min}	D ₃	B	r _{gmin}
	mm						
TZ8527	85	27	133	124	93	25.5	1
TZ7019	70	19	102	94	70.5	15.5	0.8
TZ7519	75	19	107	99	75.5	15.5	0.8
TZ8019	80	19	112	104	80.5	15.5	0.8
TZ8522	85	22	122	114	85.5	18.5	1

Bearing Designations	Boundary Dimensions					
	D _s	d _o	T _o	H	T _i	D _o
	mm					
65NL57100F0	64.7	57	100	74.9	121.5	108
44CL3639F0	44	36	38.5	68	53.5	-

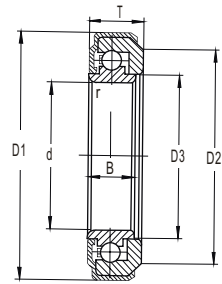

Type TZ

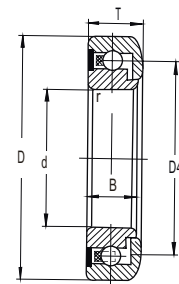

Type RTM

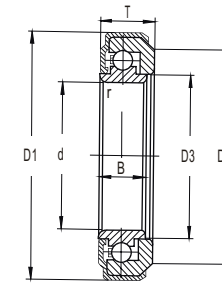

Type TZ

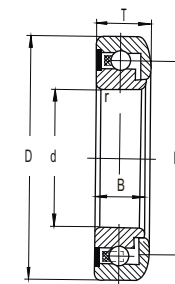

Type RTM

Bearing Designations	Boundary Dimensions					
	d	T	D	D ₃	B	r _{min}
	mm					
TM3013	30	13	55	36	12.5	0.3
TM3514	35	14	62	41	13.5	0.5
TM4015	40	15	68	46	14	0.5
TM4516	45	16	75	51	15	0.5
TM5016	50	16	80	56	15	0.5
TM5518	55	18	90	63	17	0.8
TM6018	60	18	95	68	17	0.8
TM6518	65	18	100	73	17	0.8
TM7020	70	20	110	78	18.5	0.8
TM7520	75	20	115	83	18.5	0.8
TM8022	80	22	125	88	20.5	0.8
TM8522	85	22	130	93	20.5	1

Bearing Designations	Boundary Dimensions					
	D ₄	d	T	D _{1max}	B	r _{min}
	mm					
38RTZ3013	38	30	13	49	8.5	0.3
46RTZ3315	46	33	15	60	13.5	0.5
44RTZ3515	44	35	15	57	10.5	0.5
48RTZ3816	48	38	15.5	67	14.5	0.5
50RTZ4016	50	40	16	64	11	0.5
55RTZ4516	55	45	16	70.5	11	0.5
59RTZ5016	59	50	16	74.5	11	0.5
62RTZ5321	62	53	21	84	19	0.8
65RTZ5519	65	55	19	82.5	13	0.8

Bearing Designations	Boundary Dimensions					
	D ₄	d	T	D	B	r _{min}
	mm					
61RTM3518	61	35	18	70	14	0.6
50RTM4020	50	40	20	69.7	16	0.6
55RTM4518	55	45	17.5	74	15	0.6
62RTM5521	62	55	21	82	19	0.6

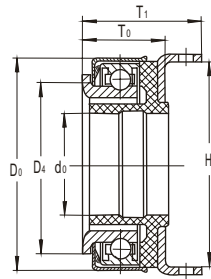

Type CT

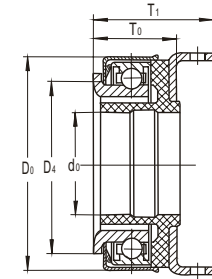

Type CT

Bearing Designations	Boundary Dimensions							
	D ₁	D ₂	D _{2min}	d ₁	T ₀	H	T ₁	D ₀
	mm							
45RWT2823F2	45.2	-	-	28	22.8	36.8	30	57
54RWT3338F2	54	-	-	33	37.5	44	47.5	74
50RWT3534F2	50	-	-	35	34	44	45	70
62RWT4437F2	62	-	-	44	36.5	53	51.5	84
WT3346F2	-	48	67	33	45.5	44	55.5	74
WT3540F2	-	56	78	35	39.5	53	51.5	84
WT4456F2	-	56	78	44	55.5	55.8	66	84
WT4855F2	-	67	90	47.5	55	86	71	90

Bearing Designations	Boundary Dimensions							
	D ₁	d ₁	d ₂	d ₀	T ₀	H	T ₁	D ₀
	mm							
44RCT2823F0	44	-	-	28	22.5	44.5	28.5	61.5
47RCT2921F0	47	-	-	29.1	20.7	37.5	34	61.8
47RCT3020F0	47	-	-	30	19.5	45	24.5	63
47RCT3123F0	47	-	-	31	23	53	37	70
54RCT3232F0	54	-	-	32	32	46	40	75
47RCT3322F1	47	-	-	33	22.3	70.4	33.5	74
54RCT3430F0	54	-	-	34	29.5	46	37	75.4
50RCT3530F0	50	-	-	35	30	44.2	41	76
54RCT3627F1	54	-	-	36	27	77.2	42	81.5
58RCT3731F1	58	-	-	37	31	56	43	90
62RCT4437F2	62	-	-	44	36.5	53	51.5	97.6
CT3346F2	-	48	62	33	45.5	43.8	55.5	75
CT4860F2	-	67.5	92	47.5	59.5	86	76	117.6
CT5554F2	-	67.5	92	55	53.5	83	83.5	117.6
CTY3026F0	-	37	47.2	30	25.5	78.7	45	67.5
CTY3414F0	-	40.5	60	34	13.5	72.5	31.5	92.5
CTY3524F0	-	37	60	34.5	23.7	46.2	32	63.5
NT3414F1	-	36.5	52.5	34	14.2	72.2	24	94.5
NT4859F2	-	67.5	92	47.5	59	86	75	114
NT5554F2	-	71	100	55	53.5	83	83.5	120
NT5737F2	-	57	95	57	37	74.9	56	102

Other Special Bearings

Track Roller Bearings	425
One-Way Bearings	427
Spherical Plain Bearings	433
Thin Section Bearings	447





Track Roller Bearings

The yoke type track roller bearings and the screw track roller bearings are commonly used in delivery mechanism roller, cam following mechanism etc. The stud type track roller can operate under some severe conditions such as high speed, over loading and impact load.

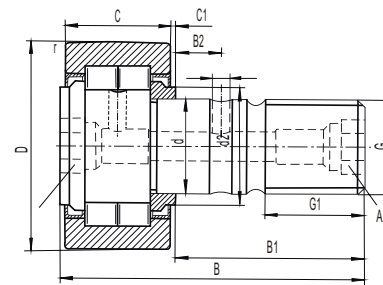

Type NUKR

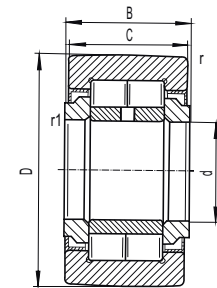

Type NUTR

Bearing Designations		Boundary Dimensions				
		d	D	B	C	r ₁ min
mm						
NUKR35	NUKR35X	16	35	52	18	0.6
NUKR40	NUKR40X	18	40	58	20	1
NUKR52	NUKR52X	20	52	66	24	1
NUKR72	NUKR72X	24	72	80	29	1.1
NUKR80	NUKR80X	30	80	100	35	1.1
NUKR90	NUKR90X	30	90	100	35	1.1

Bearing Designations		Boundary Dimensions					r ₁ min	r _{1s} min
		d	D	B	C	r ₁ min		
mm								
NUTR15	NUTR15X	15	35	19	18	0.6	0.3	
NUTR17	NUTR17X	17	40	21	20	1	0.3	
NUTR25	NUTR25X	25	52	25	24	1	0.3	
NUTR30	NUTR30X	30	62	29	28	1	0.3	
NUTR40	NUTR40X	40	80	32	30	1.1	0.6	
NUTR45	NUTR45X	45	85	32	30	1.1	0.6	
NUTR50	NUTR50X	50	90	32	30	1.1	0.6	

Limiting Speeds	Load Rating		Mass
	Grease	Dynamic Static	
r/min	kN		kg
6500	15	16.8	0.164
5500	1834	22.6	0.242
3400	29	37.5	0.45
2100	44.5	60	1.02
1800	69	98	1.6
1800	79	117	1.96

Limiting Speeds	Load Rating		Mass
	Grease	Dynamic Static	
r/min	kN		kg
6500	15	16.8	0.099
5500	18.4	22.6	0.147
3400	29	37.5	0.281
2600	40	50	0.465
1600	55	75	0.816
1400	56	78	0.883
1300	57	81	0.950



One-Way Bearings

One-way bearing can rotate freely in one direction, but deadlock in the other direction. There are many rolling shafts, needle rollers or balls in its metal shell, while its shape of rolling housing (holl) makes it only rotate in one direction, and have a large resistance in the other direction (so-called one way).

This kind of bearing is usually applied in textile machinery, printing machinery, automobile industry, household appliance and currency detector etc.

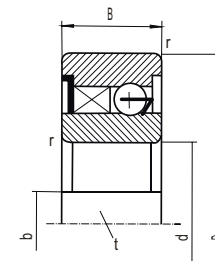

Type DX62...
Type DXN62...

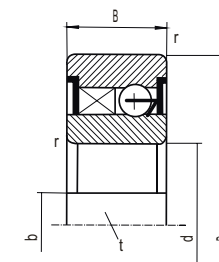

Type DX62...2RS
Type DXN62...2RS

Bearing Designations	Boundary Dimensions						
	d	D	B	r	b	t	
	mm						
DX6203	DX6203-RS	17	40	12	1.0	5	1.2
DXN6203	DXN6203-RS						
DX6204	DX6204-2RS	20	47	14	1.5	6	1.6
DXN6204	DXN6204-2RS						
DX6205	DX6205-RS	25	52	15	1.5	8	2
DXN6205	DXN6205-2RS						
DX6206	DX6206-2RS	30	62	16	1.5	8	2
DXN6206	DXN6206-RS						
DX6207	DX6207-RS	35	72	17	2.7	10	3.3
DXN6207	DXN6207-2RS						
DX6208	DX6208-2RS	40	80	18	2.7	12	3.3
DXN6208	DXN6208-2RS						
DXN6304	DXN6304-2RS	20	52	15	1.5	-	-

Moment	Limiting Speeds	Load Rating		Corresponding Designations
		Dynamic	Static	
Nm	r/min	kN		
40	3700	6555	3175	FK6203
55	3200	7325	3870	FKN6203
93	2800	7980	4570	FK6204
130	2400	8450	5290	FKN6204
202	1900	9295	6700	FK6205
200	1900	9295	6700	FKN6205
93	2800	7980	4570	FK6206
				FKN6206
				FK6207
				FKN6207
				FK6208
				FKN6208
				Fk6204

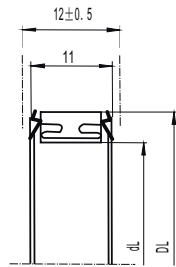

Type DX400

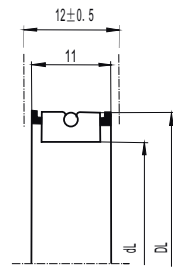

Type DX400Z

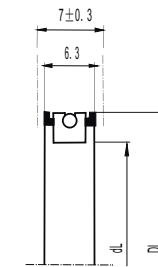

Type DX400Z2

DX400		DX400Z		DX400Z2	
Designations	Moment	Designations	Moment	Designations	Moment
Nm		Nm		Nm	
-	-	-	-	DX410 Z2	0.3
-	-	DX412 Z	3	DX412 Z2	1.8
-	-	-	-	DX413 Z2	2.9
-	-	DX414 Z	7	DX414 Z2	2.6
-	-	DX416 Z	12	DX416 Z2	7.6
DX422	48	DX422 Z	44	DX422 Z2	21
DX423	55	DX423 Z	48	DX423 Z2	24
DX425	68	DX425 Z	58	DX425 Z2	30
DX427	80	DX427 Z	66	DX427 Z2	36
DX428	87	DX428 Z	75	DX428 Z2	39
DX430	101	DX430 Z	87	DX430 Z2	46
DX432	116	DX432 Z	97	DX432 Z2	52
DX433	124	DX433 Z	107	DX433 Z2	56
DX435	141	DX435 Z	121	DX435 Z2	64
DX437	158	DX437 Z	137	DX437 Z2	71
DX438	168	DX438 Z	144	DX428 Z2	76
DX442	207	DX442 Z	178	DX442 Z2	93
DX443	217	DX443 Z	187	DX443 Z2	98
DX448	272	DX448 Z	235	DX448 Z2	122
-	-	DX450 Z	210	DX450 Z2	130
DX453	333	DX453 Z	281	DX453 Z2	146
DX458	400	DX458 Z	345	DX458 Z2	178
DX459	414	DX459 Z	357	DX459 Z2	181
DX463	472	DX463 Z	407	DX463 Z2	202
DX468	550	DX468 Z	474	DX468 Z2	243
DX470	583	DX470 Z	502	-	-
DX473	633	DX473 Z	545	-	-
DX478	722	DX478 Z	622	-	-
DX488	914	DX488 Z	788	-	-

Boundary Dimensions		Limiting Speeds		Corresponding Designations
d _L	D _L	d _L	D _L	
mm		inch		r/min
2	10	0.0787	0.3937	10000
4	12	0.1575	0.4727	10000
5	13	0.1969	0.5118	9000
6	14	0.2362	0.5512	8500
8	16	0.3150	0.6299	7500
14	22	0.5512	0.8661	5300
15	23	0.5906	0.9055	5200
17	25	0.6693	0.9843	4700
19	27	0.7480	1.0630	4400
20	28	0.7874	1.1024	4200
22	30	0.8611	1.1811	4000
24	32	0.9449	1.2598	3700
25	33	0.9843	1.2992	3600
27	35	1.0630	1.3780	3400
29	37	1.1417	1.4567	3200
30	38	1.1811	1.4960	3100
34	42	1.3386	1.6535	2800
35	43	1.3780	1.6929	2700
40	48	1.5748	1.8898	2500
42	50	1.6535	1.9685	2400
45	53	1.7717	2.0866	2200
50	58	1.9685	2.2835	2000
51	59	2.0079	2.3228	2000
55	63	2.1654	2.4803	1900
60	68	2.3622	2.6772	1750
62	70	2.4409	2.7559	1700
65	73	2.5590	2.8740	1600
70	78	2.7559	3.0709	1500
80	88	3.1496	3.4646	1300

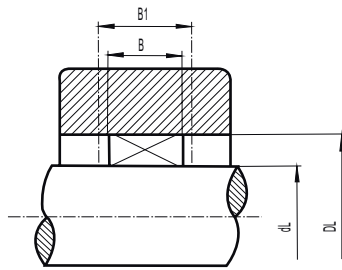

Type DX8000

Designations	Moment	Boundary Dimensions						Corresponding Designations
		d _L	D _L	B	d _L	D _L	B	
		mm			inch			
	Nm							
DX8038Z13	333	38.09	54.75	13	1.4996	2.1555	0.5118	FE8038Z13
DX8038Z16	479	38.09	54.75	16	1.4996	2.1555	0.6299	FE8038Z16
DX8038Z19	627	38.09	54.75	19	1.4996	2.1555	0.748	FE8038Z19
DX8040Z13	361	40.00	56.66	13	1.5748	2.2307	0.5118	FE8040Z13
DX8040Z16	517	40.00	56.66	16	1.5748	2.2307	0.6299	FE8040Z16
DX8040Z19	677	40.00	56.66	19	1.5748	2.2307	0.748	FE8040Z19
DX8044Z13	427	44.45	61.11	13	1.7500	2.4059	0.5118	FE8044Z13
DX8044Z16	614	44.45	61.11	16	1.7500	2.4059	0.6299	FE8044Z16
DX8044Z19	803	44.45	61.11	19	1.7500	2.4059	0.748	FE8044Z19
DX8049Z13	515	49.72	66.38	13	1.9574	2.6134	0.5118	FE8049Z13
DX8049Z16	741	49.72	66.38	16	1.9574	2.6134	0.6299	FE8049Z16
DX8049Z19	970	49.72	66.38	19	1.9574	2.6134	0.748	FE8049Z19
DX8054Z13	606	54.76	71.42	13	2.1559	2.6134	0.5118	FE8054Z13
DX8054Z16	874	54.76	71.42	16	2.1559	2.6134	0.6299	FE8054Z16
DX8054Z19	1140	54.76	71.42	19	2.1559	2.6134	0.748	FE8054Z19
DX8054Z25	1682	54.76	71.42	25	2.1559	2.6134	0.9843	FE8054Z25
DX8058Z19	1260	58.00	74.66	19	2.2835	2.9394	0.748	FE8058Z19
DX8068Z16	1266	68.00	84.66	16	2.6772	3.3331	0.6299	FE8068Z16
DX8072Z13	977	72.21	88.87	13	2.8429	3.4988	0.5118	FE8072Z13
DX8072Z16	1411	72.21	88.87	16	2.8429	3.4988	0.6299	FE8072Z16
DX8072Z19	1845	72.21	88.87	19	2.8429	3.4988	0.748	FE8072Z19
DX8072Z25	2715	72.21	88.87	25	2.8429	3.4988	0.6299	FE8072Z25
DX8079Z25	2619	79.69	96.36	25	3.1374	3.7937	0.748	FE8079Z25
DX8083Z25	3407	83.34	100.00	25	3.2811	3.9370	0.9843	FE8083Z25
DX8093Z19	2907	93.34	110.00	19	3.6748	4.3307	0.748	FE8093Z19
DX8103Z16	2674	103.23	119.89	16	4.0642	4.7201	0.6299	FE8103Z16
DX8103Z19	3322	103.23	119.89	19	4.0642	4.7201	0.748	FE8103Z19
DX8103Z25	4600	103.23	119.89	25	4.0642	4.7201	0.9843	FE8103Z25
DX8129Z25	6244	129.39	146.05	25	5.0941	5.7500	0.9843	FE8129Z25
DX8140Z25	6686	140.00	156.66	25	5.5118	6.1677	0.9843	FE8140Z25
DX8150Z25	7448	150.00	166.66	25	5.9055	6.5614	0.9843	FE8150Z25



Spherical Plain Bearings

The sliding frictional component of radial spherical plain bearing is consist of outer ring with inner spherical surface and inner ring with outer spherical surface. This kind of bearings is suitable for the machineries, which have low requirement of concentricity, and relatively big press on working surface with low speed sway, slant or rotary motion. There are mainly two kinds of sliding frictional component of radial spherical plain bearings: steel on steel radial spherical plain bearings and self-lubricating spherical plain bearings.

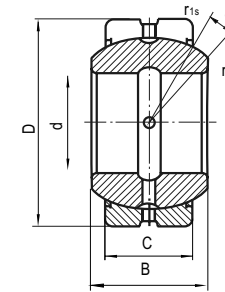

Type GE ··ES-2RS

Bearing Designations	Boundary Dimensions		
	d	D	B
	mm		
GE20ES	20	35	16
GE45ES	45	68	32
GE60ES	60	90	44
GE120ES	120	180	85
GE200ES	200	290	130
GEG20ES	20	42	25
GEG80ES	80	130	75
GEG140ES	140	230	130
GEG200ES	200	320	165
GEF20ES	20	32	16
GEF65ES	65	105	55
GEF100ES	100	160	88
GEF150ES	150	220	120
GEZ19ES	19.05	31.75	16.662
GEZ34ES	34.925	55.563	30.15
GEZ88ES	88.9	139.7	77.775
GEZ107ES	107.95	168.275	94.463
GEZ152ES	152.4	222.25	120.65
GEGZ31ES	31.75	61.913	35.306
GEGZ50ES	50.8	90.488	52.578
GEGZ95ES	95.25	158.75	94.945
GEGZ139ES	139.7	222.25	125.73
GEFZ19S	19.05	36.51	19.05
GEFZ22S	22.23	39.69	22.23
GEFZ25S	25.4	44.45	25.4

C	Boundary Dimensions			$\alpha^{\circ} \approx$	Load Ratings		Mass
	r_s min	r_{fs} min			Dynamic	Static	
	mm				kN		kg
12	0.3	0.3		9	30	146	0.066
25	0.6	1		7	127	637	0.427
36	1	1		6	245	1220	1.04
70	1	1		6	950	4750	8.05
100	1.1	1.1		7	2120	10600	28.03
16	0.3	0.6		17	48	240	0.153
50	1	1		14	488	2440	3.64
80	1	1		16	1360	6800	19.01
100	1.1	1.1		15	2320	11600	45.28
14	0.5	0.5		4	33	166	0.053
47	1	1		5	375	1870	2.05
75	1.5	1.5		5	956	4780	7.43
105	1.5	1.5		5	1820	9140	17.1
14.275	0.3	0.6		6	31	95	0.053
26.187	0.6	1		6	102	310	0.35
66.675	1	1		6	680	2040	4.8
80.95	1	1		6	1000	3000	8.41
104.775	1	1		5	1730	5200	17.5
28.575	0.6	1		15	125	375	0.454
42.85	0.6	1		14	280	850	1.68
76.2	1	1		14	900	2650	8.85
104.775	1	1		9	1730	5200	20.4
15.06	0.3	1.12		9	28	141	0.093
17.86	0.6	1.12		9.5	37	186	0.119
20.24	0.6	1.12		10	49	245	0.175

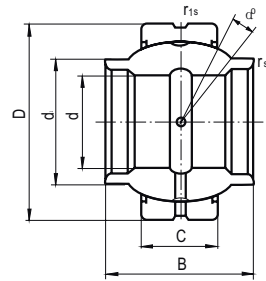

Type GEEW ... ES-2RS

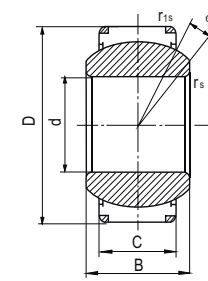

Type GEH ... XT-2RS

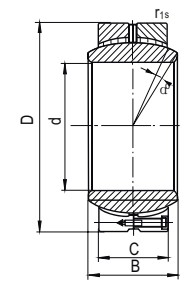

Type GEH ... HC

Bearing Designations	Boundary Dimensions			
	d	D	B	C
	mm			
GEEW20ES	20	35	20	12
GEEW63ES	63	95	63	36
GEEW200ES	200	290	200	100
	20	35	24	12
GEEM20ES-2RS	40	62	38	22
GEEM40ES-2RS	80	120	74	45
GEEM80ES-2RS	19.05	31.75	28.575	14.275
GEWZ19ES	69.85	111.125	104.775	52.375
GEWZ69ES	152.4	222.25	209.55	104.775
GEWZ152ES	20	32	16	14
GE20XS/K	90	140	76	65
GE90XS/K	150	220	120	105
GE150XS/K	20	46	25	18
GEBK20S	25	56	31	22
GEBK25S	30	66	37	25
GEBK30S	20	35	16	12
GE20C	30	47	22	18
GE30C	20	42	25	16
GEG20C	30	55	32	20
GEG30C				

C	Boundary Dimensions			Load Ratings		Mass
	r _s min	r _{1s} min	α° ≈	Dynamic	Static	
	mm			kN		kg
25	0.3	0.3	4	30	146	0.071
71.5	1	1	4	253	1260	1.25
221	1.1	1.1	4	2120	10600	32.1
24	0.3	0.3	6	30	146	0.073
45	0.6	1	4	99	495	0.35
90	0.6	1	4	400	2000	2.5
23.368	0.3	0.6	5	31	95	0.064
85.852	1	1	5	415	1250	2.9
178.308	1	1	5	1730	5200	20.7
	0.5	0.5	4	33	166	0.053
	1	1	5	718	3590	4.72
	1.5	1.5	5	1820	9140	17.1
	0.3	0.6	15	31	73	0.21
	0.6	0.6	15	47	110	0.39
	0.6	0.6	17	63	148	0.61
	0.3	0.3	9	31	78	0.066
	0.6	0.6	6	65	166	0.163
	0.3	0.3	17	51	127	0.153
	0.6	0.6	17	83	212	0.304

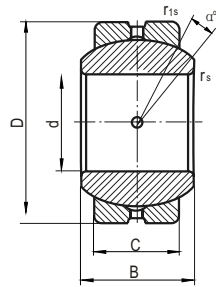

Type GEFZ...S

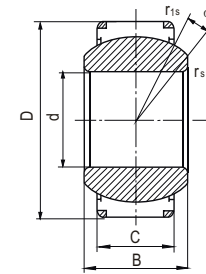

Type GEH...XT-2RS

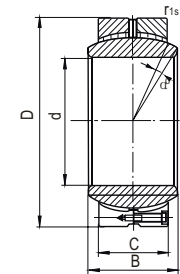

Type GEH...HC

Bearing Designations	Boundary Dimensions			
	d	D	B	C
	mm			
GEG20ET-2RS	20	42	25	16
GEG200XT-2RS	200	320	165	100
GEZ19ET-2RS	19.05	31.75	16.662	14.275
GEZ152ET-2RS	152.4	222.25	120.65	104.775
GEH100XT	100	150	71	67
GEH200XT	200	290	140	134
GEH100HC	100	150	71	67
GEH200HC	200	290	140	134
GEH100HT	100	150	71	67
GEH200HT	200	290	140	134
GEFZ19S (GEFZ19C)	19.05	36.51	19.05	15.06
GEFZ25 (GEFZ25C)	25.4	44.45	25.4	20.24

Boundary Dimensions				Load Ratings		Mass
d _i max	r _s min	r _{1s} min	α° ≈	Dynamic	Static	
mm				kN		kg
-	0.3	0.6	17	68	137	0.153
-	1.1	1.1	15	3300	6550	45.28
-	0.3	0.6	6	45	92	0.053
-	1	1	5	2600	5240	17.5
-	1	1	2	1080	2170	4.51
-	1.1	1.1	2	4180	8370	33.5
-	1	1	2	810	1350	4.51
-	1.1	1.1	2	3130	5500	33.5
-	1	1	2	860	1750	4.51
-	1.1	1.1	2	3340	6740	33.5
-	0.3	1.12	9	28(40.8)	141(102.1)	0.093
-	0.6	1.12	10	49(69.4)	245(173.5)	0.175

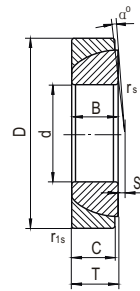

Type GAC ...T
Type GAC ...SK

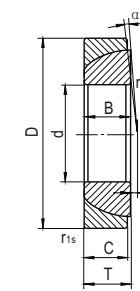

Type GAC ...T
Type GAC ...SK

Bearing Designations	Boundary Dimensions				
	d	D	B	C	T
	mm				
GAC25S	25	47	15	14	15
GAC45S	45	75	20	18	20
GAC70S	70	110	25	23	25
GAC100S	100	150	32	31	32
GAC150S	150	225	48	46	48
GAC200S	200	310	70	66	70
GAC25T	25	47	15	14	15
GAC50T	50	80	20	19	20
GAC85T	85	130	29	26.5	29
GAC120T	120	180	38	37	38
GAC160T	160	240	51	49	51
GAC200T	200	310	70	66	70
GACZ19S	19.05	31.75	10.41	7.87	11.18
GACZ44S	44.45	71.438	24.89	20.07	27.18
GACZ82S	82.55	130.175	47.24	39.24	51.56
GACZ101S	101.6	158.75	58.42	49.15	63.5
GACZ152S	152.4	222.25	78.74	66.42	85.72

Boundary Dimensions					Load Ratings		Mass
S	A	r _s	r _{1s}	alpha^circ ≈	Dynamic	Static	
mm					kN		
0.6	7.5	1	1	2.5	50	250	0.148
3.5	10	1	1	3	108	540	0.416
7.2	12.5	1.1	1	2	206	1030	1.04
11.6	16	1.5	1.5	0.5	384	1923	2.34
20	20.5	3	3	1	850	4270	8.01
26	30	3	3	1.5	1680	8420	22.5
0.6	-	1	1	2.5	75	149	0.148
4.3	-	1	1	1.5	185	370	0.455
9.4	-	1.1	1.1	2	426	851	1.61
14.5	-	2	2	0.5	820	1630	3.97
20	-	3	3	1	1445	2990	9.42
26	-	3	3	1.5	2520	5040	22.5
1.79	3.18	1	1	6	16	83	0.038
4.72	8.33	2.54	2.54	6	99	499	0.458
9.04	16.66	4.6	4.6	5	364	1820	2.89
10.4	19.84	4.6	4.6	4.5	566	2830	5.26
16.1	34.8	4.6	4.6	4.5	1080	5400	17.37

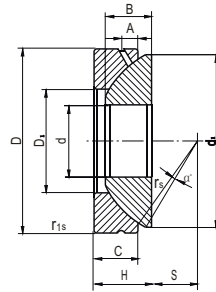

Type GX.. X

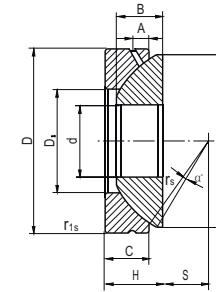

Type GX.. X

Bearing Designations	Boundary Dimensions					
	d	D	B	C	H	S
	mm					
GX20S	20	55	14.5	13.8	20	12.5
GX45S	45	120	31	25.5	36.5	27.5
GX100S	100	210	51	46	59	45
GX200S	200	340	80	66	87	70
GX20T	20	55	14.5	13.8	20	12.5
GX50T	50	130	33	30.5	42.5	30
GX120T	120	230	53.5	50	64	52.5
GX200T	200	340	80	66	87	70

d _i max	Boundary Dimensions					Load Ratings		Mass kg
	D _i min	A	r _s min	r _{1s} min	α ^o ≈	Dynamic	Static	
	mm					kN		
50	31	6	1	5		84	425	0.246
110	67	11	1	6		486	2470	2.24
198	127	15	1.1	4		1300	6470	10.9
320	247	27	1.5	1		3070	15280	34.2
50	31	-	1	5		127	255	0.246
120	70	-	1	6		840	1870	3.14
220	145	-	1.1	3		2170	4560	13.9
320	247	-	1.5	1		4780	9150	34.2

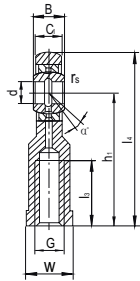

Type SI...ES

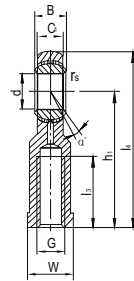

Type SIZP...S

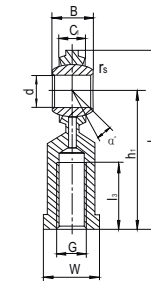

Type SIZJ ...

Bearing Designations	Boundary Dimensions							
	d	B	C ₁ max	d ₂ max	G 6H	h ₁	l ₃ min	l ₄ max
	mm							
SI5E	5	6	4.5	21	M5	30	11	40.5
SI8E	8	8	6.5	24	M8	36	15	48
SI12E	12	10	8.5	34	M12	50	18	67
SI15ES	15	12	10.5	40	M14	61	21	81
SI40ES	40	28	24	92	M39×3	142	65	188
SI80ES	80	55	48	180	M64×4	230	85	320
SIBP5S	5	8	6	16	M5	27	14	35
SIBP16S	16	21	15	38	M16	64	33	83
SIBP22S	22	28	20	50	M22×1.5	84	43	109
SIBP30S	30	37	25	70	M30×2	110	56	145
SIZP4S	4.83	7.92	6.35	15.88	10-32	26.97	14.27	34.93
SIZP9S	9.53	12.7	10.31	25.4	3/8-24	41.28	23.8	53.98
SIZP15S	15.88	19.05	14.27	38.1	5/8-18	63.5	38.1	82.55
SIZP25S	25.4	34.93	25.4	69.85	5/4-12	104.78	53.98	139.7
SIZJ4	4.83	7.92	5.94	15.88	10-32	26.97	12.7	34.93
SIZJ9	9.53	12.7	9.12	25.4	3/8-24	41.28	19.05	53.98
SIZJ12	12.7	15.88	11.5	33.32	1/2-20	53.98	25.4	70.64
SIZJ19	19.05	22.23	15.06	44.45	3/4-16	73.03	34.93	95.25
SI5C	5	6	4.5	21	M5	30	11	40.5
SI12C	12	10	8.5	34	M12	50	18	67
SI17C	17	14	11.5	46	M16	67	24	90
SI30C	30	22	20	73	M30×2	110	45	146.5
SI35ET-2RS	35	25	22	82	M36×3	125	60	166
SI45ET-2RS	45	32	28	102	M42×3	145	65	196
SI60ET-2RS	60	44	39	135	M52×3	175	70	242.5
SI80ET-2RS	80	55	48	180	M64×4	230	85	320
SIJK5C	5	8	7.5	18	M5	27	8	36
SIJK10C	10	14	11.5	30	M10	43	15	58
SIJK22C	22	28	21	56	M22×1.5	84	33	112
SIJK30C	30	37	27	70	M30×1.5	110	45	145

Boundary Dimensions						Load Ratings		Mass
l ₃ max	W	d ₃ max	d ₂ max	r _s min	α°≈	Dynamic	Static	
mm						kN		kg
5	10	10	13	0.3	13	3.4	8.1	0.016
5	13	13	16	0.3	15	5.5	12.9	0.035
7	18	19	22	0.3	10	10	24.5	0.096
8	21	21	26	0.3	8	16	36	0.162
18	60	52	65	0.6	7	99	180	206
25	95	95	110	1	6	400	750	13.04
4	9	9	11	0.3	13	3.3	4.1	0.016
8	22	22	27	0.6	15	21	25	0.225
12	32	30	37	0.6	15	38	43	0.488
15	41	40	50	0.6	17	63	86	1.13
4.75	7.92	7.54	10.31	0.3	10	3.4	4.6	0.015
6.35	14.27	13.89	17.45	0.6	9	9.4	10	0.061
7.92	22.23	21.84	25.4	0.6	11	20	21	0.19
11.1	38.1	37.72	44.45	0.6	14	60	101	1
4.75	7.92	7.54	10.31	0.3	10	3.6	6.8	0.018
6.35	14.27	13.89	17.45	0.6	11	11	16	0.059
6.35	19.05	18.67	22.23	0.6	10	18	28	0.132
7.92	25.4	25.02	28.58	0.6	12	34	44	0.295
5	10	10	13	0.3	13	3.6	8.1	0.016
7	18	19	22	0.3	10	11	24.5	0.096
10	27	25	29	0.3	10	22	45	0.23
15	46	42	50	0.6	6	65	110	0.97
15	55	48	58	0.6	6	112	146	1.5
20	65	58	70	0.6	7	180	240	2.7
20	80	70	88	1	6	345	450	5.6
25	95	95	110	1	6	567	750	13
4	10	9	12	0.3	4	3.6	4.6	0.016
6.5	16	15	19	0.6	10	12	15	0.088
12	34	30	37	0.6	14	42	50	0.61
15	46	40	50	0.6	15	73	77	1.4

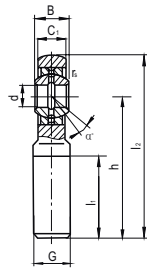

Type SA...ES

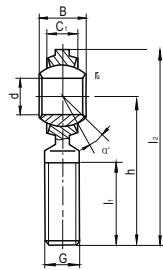

Type SAZJ ...

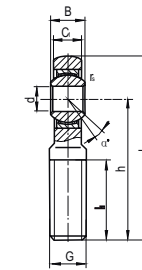

Type SAJK...C

Bearing Designations	Boundary Dimensions				
	d	B	C ₁ max	d ₂ max	G eg
	mm				
SA5E	5	6	4.5	21	M5
SA12E	12	10	8.5	34	M12
SA15ESD	15	12	10.5	40	M14
SA20ES	20	16	13.5	53	M20×1.5
SA45ES	45	32	28	102	M42×3
SA80ES	80	55	48	180	M64×4
SABP5S	5	8	6	16	M5
SABP10S	10	14	10.5	26	M10
SABP18S	18	23	16.5	42	M18×1.5
SABP22S	22	28	20	50	M22×1.5
SABP30S	30	37	25	70	M30×2
SAZP4S	4.83	7.92	6.35	15.88	10-32
SAZP9S	9.53	12.7	10.31	25.4	3/8-24
SAZP15S	15.88	19.05	14.27	38.1	5/8-18
SAZP25S	25.4	34.93	25.4	69.85	5/4-12
SAZJ4	4.83	7.92	5.94	15.88	10-32
SAZJ12	12.7	15.88	11.5	33.32	1/2-20
SAZJ19	19.05	22.23	15.06	44.45	3/4-16
SA5C	5	6	4.5	21	M5
SA12C	12	10	8.5	34	M12
SA17C	17	14	11.5	46	M16
SA30C	30	22	20	73	M30×2
SA35ET-2RS	35	25	22	82	M36×3
SA45ET-2RS	45	32	28	102	M42×3
SA60ET-2RS	60	44	39	135	M52×3
SA80ET-2RS	80	55	48	180	M64×4
SAJK5C	5	8	7.5	18	M5
SAJK16C	16	21	15.5	42	M16
SAJK22C	22	28	21	56	M22×1.5
SAJK30C	30	37	27	70	M30×2

Boundary Dimensions					Load Ratings		Mass
h	l ₁ min	l ₂ max	r _s min	α° ≈	Dynamic	Static	
mm					kN		kg
36	16	46.5	0.3	13	3.4	3.9	0.011
54	28	71	0.3	10	10	23	0.066
63	34	83	0.3	8	16	32	0.121
78	43	104.5	0.3	9	30	60	0.283
163	92	214	0.6	7	127	240	2.57
270	140	360	1	6	400	750	12.06
33	20	41	0.3	13	3.3	3.9	0.016
48	29	61	0.6	14	10	11	0.072
72	44	93	0.6	15	26	30	0.295
84	51	109	0.6	15	38	43	0.488
110	66	145	0.6	17	63	86	1.13
31.75	19.05	39.7	0.3	10	3.4	3.8	0.013
49.23	31.75	61.93	0.6	9	9.4	10	0.055
66.68	41.28	85.73	0.6	11	20	21	0.18
104.78	53.98	139.7	0.6	14	60	101	1.1
31.75	19.05	39.7	0.3	10	3.6	3.8	0.014
61.93	38.1	78.59	0.6	10	18	28	0.11
73.03	44.45	95.25	0.6	12	34	44	0.26
36	16	46.5	0.3	13	3.6	3.9	0.011
54	28	71	0.3	10	11	23	0.066
69	36	92	0.3	10	22	44	0.17
110	65	146.5	0.6	6	65	110	0.84
140	82	181	0.6	6	112	146	1.4
163	92	214	0.6	7	180	240	2.5
210	115	277.5	1	6	345	450	5.7
270	140	360	1	6	567	750	12
33	19	42	0.3	4	3.6	3.9	0.013
66	37	87	0.6	14	23	29	0.22
84	48	112	0.6	14	42	50	0.49
110	66	145	0.6	15	73	77	1.1



Thin Section Bearings

This series of bearings have a very thin ring and a small cross section, and its features are light weight, low friction, high rigidity and relatively high rotation precision. It is especially suitable for compact light configuration with relatively high rigidity and bigger bore diameter. LYC thin-section bearings are used widely in Aircraft, Aerospace, Textile printer, Medical devices, Radar Communication, Astronomy instrumentation and Industrial robotics etc.

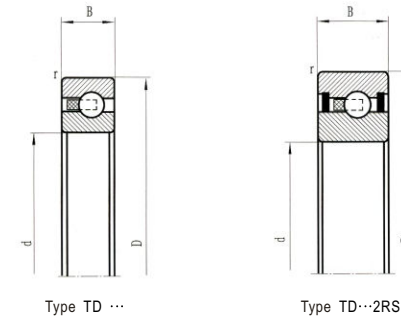

Bearing Designations	Boundary Dimensions				r _s min
	d		D	B	
	mm	inch	mm		
TD61100A	24.5	1	34.925	4.762	0.4
TD61108A	38.1	1-1/2	47.625	4.762	0.4
TD62200A	50.8	2	63.5	6.35	0.65
TD63200A	50.8	2	66.675	7.938	1.1
TD62208A	63.5	2-1/2	76.2	6.35	0.65
TD63208A	63.5	2-1/2	79.375	7.938	1.1
TD62300A	76.2	3	88.9	6.35	0.65
TD63308A	88.9	3-1/2	104.775	7.938	1.1
TD64400A	101.6	4	120.65	9.525	1.1
TF65404-2RS-A	107.95	4-1/4	127	12.7	0.4
TD67404A	107.95	4-1/4	146.05	19.05	2.1
TD63408M	114.3	4-1/2	130.175	7.938	1.1
TD66408A	114.3	4-1/2	139.7	12.7	1.6
TD62500M	127	5	139.7	6.35	0.65
TD64500A	127	5	146.05	9.525	1.1
TD66508A	139.7	5-1/2	165.1	12.7	1.6
TD68608A	139.7	5-1/2	190.5	25.4	2.1
TF65600-2RS-M	152.4	6	171.45	12.7	0.4
TD67608A	165.1	6-1/2	203.2	19.05	2.1
TD68508A	165.1	6-1/2	215.9	25.4	2.1
TD62700M	177.8	7	190.5	6.35	0.65
TD64700A	177.8	7	196.85	9.525	1.1
TD66708M	190.5	7-1/2	215.9	12.7	1.6
TD68708A	190.5	7-1/2	241.3	25.4	2.1
TD63800M	203.2	8	219.075	7.938	1.1
TF65800-2RS-M	203.2	8	222.25	12.7	0.4
TD67900A	228.6	9	266.7	19.05	2.1
TD661000M	254	10	279.4	12.7	1.6
TD641100M	279.4	11	298.4	9.525	1.1
TF651200-2RS-M	304.8	12	323.85	12.7	0.4
TD681400A	355.6	14	406.4	25.4	2.1

Limiting Speeds		Load Ratings		Mass
Grease	Oil	Dynamic	Static	
r/min		kN		
18000	28000	2.5	1.76	0.012
9500	15000	2.8	2.32	0.018
7500	11000	4.5	3.9	0.041
8000	12000	6.4	5.2	0.065
5300	7500	4.9	4.65	0.05
6000	8500	6.95	6.2	0.079
4000	5600	5.2	5.4	0.059
3600	5000	7.8	8.15	0.107
3200	4500	10.4	11	0.178
2000	-	10.6	11.6	0.267
4300	6000	29	26.5	0.816
2600	3800	8.5	10.2	0.149
3000	4300	16.3	17	0.361
2200	3400	6.2	8.5	0.104
2400	3600	11.2	13.2	0.219
2400	3600	17.6	20	0.433
3200	4500	46.5	45	1.89
1300	-	11.8	15.6	0.394
2200	3400	33.5	36.5	1.18
2600	3800	50	51	2.19
1400	2000	6.95	11.6	0.144
1500	2200	12.5	18	0.331
1500	2200	19.6	26	0.641
2000	3200	53	57	2.48
1200	1800	10.4	17.3	0.257
900	-	13.2	20	0.517
1400	2000	37.5	48	1.59
1100	1700	21.6	34	0.842
900	1400	14.6	27	0.511
560	-	15	29	0.764
850	1300	65.5	98	4.38

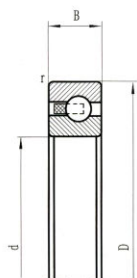

Type TD ...

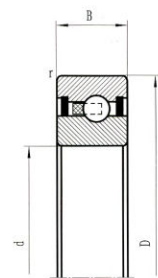

Type TD...2RS

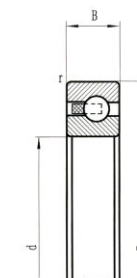

Type TD ...

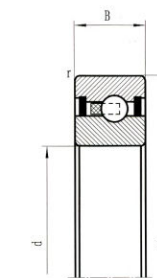

Type TD...2RS

Bearing Designations	Boundary Dimensions				
	d		D	B	r _{min}
	mm	inch	mm		
TD681600A	406.4	16	457.2	25.4	2.1
TD681800M	457.2	18	508	25.4	2.1
TD72200M	50.8	2	63.5	6.35	0.65
TD73208M	63.5	2-1/2	79.375	7.938	1.1
TD72300M	76.2	3	88.9	6.35	0.65
TD73308M	88.9	3-1/2	104.775	7.938	1.1
TD74400M	101.6	4	120.65	9.525	1.1
TD76404M	107.95	4-1/4	133.35	12.7	1.6
TD72408M	114.3	4-1/2	127	6.35	0.65
TD73412M	120.65	4-3/4	136.525	7.938	1.1
TD74500M	127	5	146.05	9.525	1.1
TD76508M	139.7	5-1/2	165.1	12.7	1.6
TD77600M	152.4	6	190.5	19.05	2.1
TD78608M	165.1	6-1/2	215.9	25.4	2.1
TD73700M	177.8	7	193.675	7.938	1.1
TD77800M	203.2	8	241.3	19.05	2.1
TD78900M	228.6	9	279.4	25.4	2.1
TD771000M	254	10	292.1	19.05	2.1
TD771200M	304.8	12	342.9	19.05	2.1
TD781400M	355.6	14	406.4	25.4	2.1

Limiting Speeds		Load Ratings		Mass
Grease	Oil	Dynamic	Static	
r/min		kN		kg
700	1000	69.5	110	4.97
600	850	72	122	6.15
10000	15000	4.75	4.4	0.046
8000	11000	7.35	7.2	0.088
5600	7500	5.4	6.2	0.066
5000	6700	8.15	9.8	0.12
4500	6000	11.2	13.2	0.201
4500	6000	17	18.3	0.386
3400	4500	6.3	8.8	0.097
3400	4500	9.15	12.5	0.159
3400	4500	12.2	16.3	0.247
3200	4300	18.3	22.8	0.488
3400	4500	34.5	40.5	1.25
3400	4500	53	60	2.48
2200	3200	10.4	17.6	0.23
2200	3200	38	51	1.62
2200	3200	60	76.5	3.32
1700	2400	41.5	63	1.99
1300	1800	44	73.5	2.36
1200	1700	69.5	112	4.98

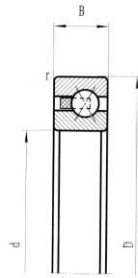

Type TDQJ ...

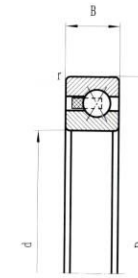

Type TDQJ ...

Bearing Designations	Boundary Dimensions				
	d		D	B	r _s min
	mm	inch	mm		
TDQJ1100A	25.4	1	34.925	4.762	0.4
TDQJ1108A	38.1	1-1/2	47.625	7.625	0.4
TDQJ2200A	50.8	2	63.5	6.35	0.65
TDQJ3208A	63.5	2-1/2	79.375	7.938	1.1
TDQJ2300A	76.2	3	88.9	6.35	0.65
TDQJ2308M	88.9	3-1/2	101.6	6.35	0.65
TDQJ4400A	101.6	4	120.65	9.525	1.1
TFQJ5404-2RS-A	107.95	4-1/4	127	12.7	0.4
TDQJ6408A	114.3	4-1/2	139.7	12.7	1.6
TDQJ7412A	120.65	4-3/4	158.75	19.05	2.1
TDQJ8500A	127	5	177.8	25.4	2.1

Limiting Speeds		Load Ratings		Mass
Grease	Oil	Dynamic	Static	
r/min		kN		kg
10000	13000	2.55	1.86	0.012
6300	7500	2.9	2.6	0.017
4500	5300	4.65	4.3	0.04
3600	4300	7.1	6.95	0.079
2800	3400	5.3	6.3	0.058
2400	3000	5.6	7.35	0.067
2000	2600	10.6	12.7	0.176
1300	-	10.85	13.4	0.248
1800	2200	16.6	19.3	0.358
1700	2000	31	31.5	0.885
1700	2000	48	45	1.72

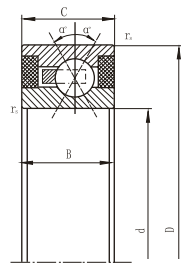

Type FPXU ···2RZ

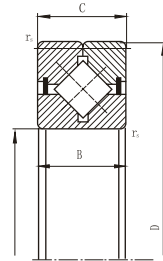

Type CRB ···2RS

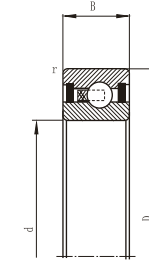
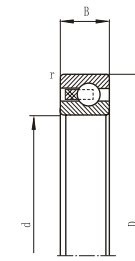

Bearing Designations	Boundary Dimensions				
	d	D	B	C	r _{min}
	mm				
FPXU400-2RZ	101.60	120.65	12.7	12.7	0.2
FPXU404-2RZ	107.95	127.00	12.7	12.7	0.2
FPXU408-2RZ	114.30	133.35	12.7	12.7	0.2
FPXU412-2RZ	120.65	139.70	12.7	12.7	0.2
FPXU500-2RZ	127.00	146.05	12.7	12.7	0.2
FPXU508-2RZ	139.70	158.75	12.7	12.7	0.2
FPXU600-2RZ	152.40	171.45	12.7	12.7	0.2
FPXU608-2RZ	165.10	184.15	12.7	12.7	0.2
FPXU700-2RZ	177.80	196.85	12.7	12.7	0.2
FPXU708-2RZ	190.50	209.55	12.7	12.7	0.2
FPXU800-2RZ	203.20	222.25	12.7	12.7	0.2
FPXU900-2RZ	228.60	247.65	12.7	12.7	0.2
FPXU1000-2RZ	254.00	273.05	12.7	12.7	0.2
FPXU1100-2RZ	279.40	298.45	12.7	12.7	0.2
FPXU1200-2RZ	304.80	323.85	12.7	12.7	0.2
CRB3010-2RS	30	55	10	10	0.5
CRB4010+2RS	40	65	10	10	0.5
CRB5015-2RS	50	80	15	15	0.5
CRB6015-2RS	60	90	15	15	1
CRB7015-2RS	70	100	15	15	1
CRB8020-2RS	80	130	20	20	1
CRB9020-2RS	90	140	20	20	1.5
CRB10020-2RS	100	150	20	20	1.5
CRB12025-2RS	120	180	25	25	2
CRB13025-2RS	130	190	25	25	2
CRB15025-2RS	150	210	25	25	2
CRB20025-2RS	200	260	25	25	2.5
CRB25025-2RS	250	310	25	25	2.5
CRB30025-2RS	300	395	35	35	3
CRB40040-2RS	400	510	40	40	3.5
CRB50040-2RS	500	600	40	40	3.5

Bearing Designations	Boundary Dimensions			Deformation max	Moment Ratings (low speed shaft)	Speeds	Mass
	d	D	B				
	mm				kg/m	r/min	kg
904KAT2	18.8	25	4	0.2	0.2	3000	0.004
905KAT2	24	32	5	0.2	0.6	3000	0.008
806KAT2	30	40	6	0.3	1.6	3000	0.015
907KAT2	37	50	8	0.3	3	3000	0.04
809KAT2	45	60	9	0.4	5	3000	0.055
911KAT2	57	75	13	0.5	8.5	3000	0.08
812KAT2	60	80	13	0.5	12	3000	0.15
814KAT2	70	95	15	0.6	20	3000	0.19
815KAT2	75	100	15	0.6	25	3000	0.27
818KAT2	90	120	18	1.0	45	3000	0.37
822KAT2	110	150	24	1.0	80	3000	0.84
824KAT2	120	160	24	1.0	100	1500	0.88
826KAT2	130	175	26	1.0	120	1500	1.4
830KAT2	150	200	30	1.3	200	1500	1.8
832KAT2	160	220	35	1.3	250	1500	2.7
836KAT2	180	240	35	1.5	315	1500	2.95
838KAT2	190	250	40	1.5	350	1500	3.38
842KAT2	210	280	45	1.5	400	1500	5.51
844KAT2	220	300	45	1.5	500	1500	6.8

Balls and Rollers

Balls 457

Rollers 461





Balls and Rollers

balls

Balls

LYC can produce many kinds of bearing steel balls and stainless steel balls ranged from 3.175mm to 152mm with the accuracy grade from G5 to G100. The vibration value of single ball is from Z1 to Z5. The balls are suitable to be applied in various industries of manufacture, wind power, mining, metallurgy, transportation and aviation etc.

Symbols, definitions

D_w nominal ball diameter

D_{ws} single ball diameter

V_{Dws} ball diameter variation

V_{DwL} variation of ball lot diameter

R_s surface roughness

Table 1 Hardness of Carbon Chromium Steel balls

D_w		Hardness
over	incl.	
mm		HRC
-	30	61~66
30	50	59~64
50	-	58~64

Table 2 Spherical Deviation and Surface Roughness

Grade	V_{Dws}	Spherical Deviation	R_s
	max	max	max
	μm	μm	μm
G3	0.08	0.08	0.010
G5	0.13	0.13	0.014
G10	0.25	0.25	0.020
G16	0.4	0.4	0.025
G20	0.5	0.5	0.032
G24	0.6	0.6	0.040
G28	0.7	0.7	0.050
G40	1	1	0.060
G60	1.5	1.5	0.080
G100	2.5	2.5	0.100
G200	5	5	0.150

Table 3 Tolerances of Hardened Carbon Chromium Steel Balls

Grade	V_{DwL}	Gauge Interval	Gauge		Subgauge Interval	Subgauge			
	max								
	μm	μm	μm		μm	μm			
G3	0.13	0.5	-0.5...0.5	0	+0.5...+5	0.1	-0.2,-0.1	0	+0.1,+0.2
G5	0.25	1	-5...-1	0	+1...+5	0.2	-0.4,-0.2	0	+0.2,+0.4
G10	0.5	2	-9...-1	0	+1...+9	0.2	-0.4,-0.2	0	+0.2,+0.4
G16	0.8	2	-10...-2	0	+2...+10	0.4	-0.8,-0.4	0	+0.4,+0.8
G20	1	2	-10...-2	0	+2...+10	0.4	-0.8,-0.4	0	+0.4,+0.8
G24	1.2	2	-12...-2	0	+2...+12	0.4	-0.8,-0.4	0	+0.4,+0.8
G28	1.4	2	-12...-2	0	+2...+12	0.4	-0.8,-0.4	0	+0.4,+0.8
G40	2	4	-16...-4	0	+4...+16	0.8	-1.6,-0.8	0	+0.8,+1.6
G60	3	6	-18...-6	0	+6...+18	1.2	-2.4,-1.2	0	+1.2,+2.4
G100	5	10	-40...-10	0	+10...+40	2	-4,-2	0	+2,+4
G200	10	15	-60...-15	0	+15...+60	3	-6,-3	0	+3,+6

Table 4 Material for LYC balls

Material		Chemical Composition (%)			
Chinese Standard	Equivalent	C	Si	Mn	P
GCr15	AISI E52100	0.95~1.05	0.15~0.35	0.25~0.45	0.025max
GCr15SiMn	DIN 100CrMn6	0.95~1.05	0.40~0.65	0.95~1.25	0.025max
9Cr18Mo	AISI440C	0.95~1.10	0.80max	0.80max	0.035max
9Cr18	AISI440C	0.90~1.00	0.80max	0.80max	0.035max

Chemical Composition (%) (continue)					Standard
S	Ni	Cr	Mo	Cu	
0.025max	0.30max	1.40~1.65	0.10max	0.25max	GB/T18254—2002
0.025max		1.40~1.65			GB/T18254—2002
0.030max		16.00~18.00	0.40~0.70		GB/T1220-1992
0.030max		17.00~19.00			GB 3086-82

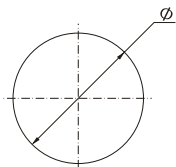

Nominal Diameter

The sizes of LYC balls

Nominal Dia.(φ)		Nominal Dia.(φ)		Nominal Dia.(φ)	
inch	metric	inch	metric	inch	metric
1/8	3.1750		10.5000	13/16	20.6375
	3.5000		11.0000		22.0000
5/32	3.9688	7/16	11.1125	7/8	22.2250
	4.0000	29/64	11.5094	29/32	23.0188
	4.5000	15/32	11.9062	15/16	23.8125
3/16	4.7625		12.0000		24.0000
	5.0000	31/64	12.3031		24.5000
	5.5000	1/2	12.7000		25.0000
7/32	5.5562		13.0000	1	25.4000
15/64	5.9531	17/32	13.4938		25.4000
	6.0000		14.0000		26.0000
1/4	6.3500	9/16	14.2875		26.5000
	6.5000		14.5000	1 1/16	26.9875
17/64	6.7469		15.0000		27.5000
	7.0000	19/32	15.0812		28.0000
9/32	7.1438	5/8	15.8750	1 1/8	28.5750
	7.5000		16.0000		29.0000
5/16	7.9375	21/32	16.6688		29.5000
	8.0000		17.0000		30.0000
	8.5000	11/16	17.4625	1 3/16	30.1625
11/32	8.7312		18.0000		30.5000
	9.0000	23/32	18.2562		31.0000
3/8	9.5250		18.5000		31.5000
	10.0000	3/4	19.0500	1 1/4	31.7500
13/32	10.3188	25/32	19.8438		32.0000

Nominal Dia.(φ)		Nominal Dia.(φ)	
inch	metric	inch	metric
1 5/16	33.3375		90.0000
1 3/8	34.9250		100.0000
1 7/16	36.5125	4	101.6000
1 1/2	38.1000		102.0000
1 9/16	39.6875		103.0000
	40.0000		104.0000
1 5/8	41.2750		110.0000
1 11/16	42.8625	5	127.0000
1 3/4	44.4450	6	152.4000
	45.0000		
1 7/8	47.6250		
2	50.8000		
2 1/8	53.9750		
	55.0000		
2 1/4	57.1500		
	60.0000		
2 3/8	60.3250		
2 1/2	63.5000		
	65.0000		
2 3/4	69.8500		
	70.0000		
	75.0000		
3	76.2000		
	80.0000		
3 1/2	88.9000		

Rollers

LYC is able to manufacture tapered, cylindrical and spherical rollers, there are more than 800 sizes (OD from 5 to 80mm) in different types and different tolerances. LYC also can manufacture the rollers in special profile as per clients' drawings to meet their individualized demands. Its products are suitable for the bearings used in the industries of machine building, motors, railways, mining, steel mill and precision instruments, etc.

Symbols, definitions

- D_w nominal diameter
- l central section of roller length
- l_G roller diameter gauge interval
- l_{GL} roller length gauge interval
- L_w nominal length
- S_{Dw} circle run-out for reference faces
- R_a surface roughness
- V_{DwL} variation of roller lot diameter
- V_{Dwp} variation of roller diameter in a single plane
- V_{LwL} variation of lot length
- $V_{\varphi L}$ variation of lot taper angle
- ΔC_{ir} deviation from circular form
- $\Delta 2\varphi$ deviation for taper angle

1. Cylindrical Rollers

Table 1.1 Dimensional and Form Accuracy of Cylindrical Rollers

Grade	L_w		V_{LwL} max	l_{GL} μm	Guage μm	S_{Dw} max μm
	over	incl.				
	mm					
0	—	26	6	6	-30,.....,-6, 0	3
	26	—				
I	—	26	10	6	-30,.....,-6, 0	5
	26	—				
II	—	26	14	6	-30,.....,-6, 0	6
	26	50				
III	—	26	20	8	-32,.....,-8, 0	10
	26	50				

Table 1.2 Surface Roughness for Cylindrical Rollers

Grade	Rolling Surface	R_a		Chamfer
		End Face		
		μm	max	
0	0.1	0.125	1.25	1.25
I	0.125	0.16	1.25	1.25
II	0.16	0.25	2.5	2.5
III	0.25	0.32	2.5	2.5

Table 1.3 Dinsional and Form Accuracy of Cylindrical Rollers

Grade	D_w		V_{DwL}^a max	l_G μm	Guage			ΔC_{ir} max μm
	over	incl.			μm			
	mm		μm	μm				μm
0	—	18	1	1	-10,.....,-1	0	+1,.....,+5	0.3
	18	30						
I	—	18	2	1.5	-10,.....,-1	0	+1,.....,+5	0.4
	18	30						
II	—	18	3	1.5	-10,.....,-1	0	+1,.....,+5	0.5
	18	30						
III	—	18	4	1	-10,.....,-1	0	+1,.....,+5	1
	18	30						
	—	30	5	3	-19.5,.....,-1.5	0	+1.5,.....,+6	1
	30	—						
	—	30	5	3	-20,.....,-2	0	+2,.....,+6	1.5
	30	—						
	—	30	5	3	-24,.....,-3	0	+3,.....,+6	2.5
	30	—						

^a Suitable to the central section of roller length

2. Spherical Rollers

Table 2.1 Dimensional and Form Accuracy of Spherical Rollers

Grade	D_w		V_{Dwp}	ΔC_{ir} max	S_{Dw}	V_{DwL}
	over	incl.				
	mm		μm			
II	-	10	1.5	1.5	3.0	3.0
	10	18	1.5	1.5	4.0	3.0
	18	30	2.5	2.5	5.0	4.0
	30	50	3.0	3.0	6.0	5.0
	50	80	4.0	4.0	8.0	6.0
III	80	120	5.0	5.0	9.0	7.0
	-	10	2.0	2.0	5.0	4.0
	10	18	2.0	2.0	6.5	4.0
	18	30	3.0	3.0	8.5	5.0
	30	50	4.0	4.0	10.0	6.0
	50	80	5.0	5.0	12.0	7.0
	80	120	6.0	6.0	13.0	8.0



Table 2.2 Surface Roughness for Spherical Rollers

Grade	Rolling Surface	R _a	
		Reference face max	Non-reference Face
μm			
II	0.125	0.40	2.50
	0.125	0.40	2.50
	0.160	0.40	2.50
	0.250	0.40	2.50
III	0.320	0.40	2.50
	0.400	0.63	5.00
	0.160	0.40	2.5
	0.160	0.40	2.5
	0.250	0.40	2.5
	0.320	0.40	2.5
	0.400	0.40	2.5
	0.630	0.63	5.0

3. Tapered Rollers

Table 3.1 Dimensional and Form Accuracy of Tapered Rollers

Grade	D _w		V _{DWP}	ΔC _{fr}	S _{Dw}	Δ2φ ¹⁾		V _{DwL}	V _{zφL} ¹⁾
	over	incl.				up	down		
	mm		μm		μm		μm		
0	-	10	0.3	1.0	+0.6	-0.6	1.0	0.6	
	10	18	0.3	1.0	+0.7	-0.7	1.0	0.7	
	18	30	0.4	2.0	+0.7	-0.7	1.0	0.7	
I	-	10	0.5	2.0	+1.0	-1.0	1.0	1.0	
	10	18	0.5	2.5	+1.0	-1.0	1.5	1.0	
	18	30	0.8	3.0	+1.5	-1.5	2.0	1.5	
II	-	10	1.2	3.0	+2.0	-2.0	2.0	2.0	
	10	18	1.2	4.0	+2.0	-2.0	2.5	2.0	
	18	30	1.5	5.0	+2.5	-2.5	3.0	2.5	
	30	50	2.0	6.0	+3.0	-3.0	3.0	3.0	
III	-	10	2.0	5.0	+2.0	-2.0	3.0	3.0	
	10	18	2.0	6.5	+3.0	-3.0	3.0	3.0	
	18	30	3.0	8.5	+4.0	-4.0	5.0	5.0	
	30	50	3.0	10.0	+5.0	-5.0	5.0	5.0	
	50	80	4.0	12.0	+5.0	-5.0	5.0	5.0	

¹⁾ The value ranges in the effective length of rollers and expressed by the radial dimension variation.

Table 3.2 Surface Roughness for Tapered Rollers

Grade	Rolling Surface	R _a	
		Reference face max	Non-reference Face
μm			
0	0.04	0.1	1.25
I	0.08	0.125	1.25
II	0.125	0.16	2.5
III	D _w ≤ 30mm	0.16	0.32
	D _w > 30mm	0.25	

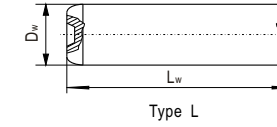
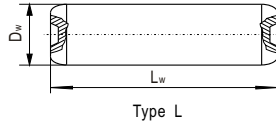

LYC Cylindrical Rollers

No.	Designations	Dimensions		Mass	Bearing No. for Reference
		D _w	L _w		
		mm		kg	
1	5×6	5	6	0.00092	Y30-2B
2	5×8	5	8	0.00122	NUTR205
3	5×9	5	9	0.00135	LY-N010
4	5.5×5.5	5.5	5.5	0.00101	N82/32M
5	6×6	6	6	0.00132	81108/P4
6	6×8	6	8	0.00176	
7	6×10	6	10	0.00219	NUTR3072X
8	6×12	6	12	0.00265	LY-NU15
9	6.35×31	6.35	31	0.00760	
10	6.35×41.28	6.35	41.28	0.01000	
11	6.5×6.5	6.5	6.5	0.00170	N204
12	6.5×20.5	6.5	20.5	0.00531	NA6915A.R200.250.S3
13	7×7	7	7	0.00208	NN3010K/P5
14	7×10	7	10	0.00288	
15	7×16	7	16	0.00479	
16	7×29.8	7	29.8	0.00893	LY-Z009
17	7.5×7.5	7.5	7.5	0.00256	N206
18	7.5×9	7.5	9	0.00300	NJ206ETM1
19	7.5×10	7.5	10	0.00380	NUTR310
20	7.5×11	7.5	11	0.00379	LY-N014
21	7.5×39.8	7.5	39.8	0.01370	
22	8×10	8	10	0.00391	NU1012M
23	8×12	8	12	0.00469	LY-N016
24	8×18	8	18	0.00704	
25	8.5×25	8.5	25	0.01100	NUTR60130X
26	9×9	9	9	0.00440	NCL303
27	9×10	9	10	0.00476	NU206E
28	9×12	10	11	0.00649	NJ305ETN1
29	9×14	10	14	0.00855	
30	9×18	10	16	0.00956	NUP2306M
31	9×21	10	20	0.01220	
32	9.525×50.8	10	24	0.01470	LY-N026
33	9.525×63.5	10	45.8	0.02820	
34	10×10	10	49.8	0.03057	NAV3956(3074956)
35	10×11	11	11	0.00780	NF307
36	10×14	11	12	0.00850	NF306E
37	10×16	11	15	0.01100	NJ2307M
38	10×20	11	27	0.01990	
39	10×24	11.56	14	0.01100	NUP2306EV
40	10×45.8	12	12	0.01050	N212
41	10×49.8	12	14	0.01230	NJ211
42	11×11	12	15.5	0.01330	
43	11×12	12	16	0.01340	LY-N036
44	11×15	12	18	0.01580	
45	11×27	12	21	0.01840	NU2307EF1
46	11.56×14	12	30	0.02640	
47	12×12	12.1	14	0.01260	NUP307EV/C9
48	12×14	12.5	48	0.04590	
49	12×15.5	12.5	62	0.05930	NA4860

No.	Designations	Dimensions		Mass	Bearing No. for Reference
		D _w	L _w		
		mm		kg	
50	12×16	13	13	0.01340	
51	12×18	13	15	0.01550	NUP2207X1V/C9YB2
52	12×21	13	18	0.01850	
53	12×30	13	20	0.02050	NNF5030-2LSV/YA1
54	12.1×14	13	33	0.03410	
55	12.5×48	12.5	48	0.04590	
56	12.5×62	12.5	62	0.05930	NA4860
57	13×13	13	13	0.01340	
58	13×15	13	15	0.01550	NUP2207X1V/C9YB2
59	13×18	13	18	0.01850	
60	13×20	13	20	0.02050	NNF5030-2LSV/YA1
61	13×33	13	33	0.03410	
62	14×14	14	14	0.01600	N309
63	14×15	14	15	0.01770	NU308EPC/P5
64	14×17	14	17	0.01990	NUP309ENV
65	14×20	14	20	0.02400	N2309M
66	14×22	14	22	0.02590	NJ2308E
67	15×15	15	15	0.02060	N216M
68	15×16	15	16	0.02150	
69	15×17	15	17	0.02290	N215EF1
70	15×22	15	22	0.03020	NU2310M
71	15×25	15	25	0.03400	LY-N028
72	15×37.5	15	37.5	0.05150	
73	16×16	16	16	0.02500	
74	16×17	16	17	0.26300	NH310EF1
75	16×20	16	20	0.03080	130.36.2700.04/34
76	16×24	16	24	0.03670	NU2216EQ1/P63SO
77	16×27	16	27	0.04140	NJ2310EM/C9SO
78	16×36	16	36	0.05620	LY-N021
79	16×44.9	16	44.9	0.07020	
80	16×50	16	50	0.07780	NAL4120M/YA
81	16×61	16	61	0.09950	
82	16×80	16	80	0.12500	
83	17×17	17	17	0.03000	N311M
84	17×20	17	20	0.03500	FC2842125
85	17×24	17	24	0.04200	NU2311M
86	17×27	17	27	0.04720	FC2842155
87	18×18	18	18	0.03560	N312
88	18×19	18	19	0.03730	NU311EPC/P5
89	18×24	18	24	0.04600	
90	18×35	18	35	0.06820	FC3854200
91	18.5×18	18.5	18	0.03760	1797/235
92	19×19	19	19	0.04230	N313/V1
93	19×20	19	20	0.44000	NJ312EF1
94	19×28	19	28	0.06180	
95	19×32	19	32	0.06950	N2312EF1
96	20×20	20	20	0.04900	N314M
97	20×30	20	30	0.07200	
98	20×75	20	75	0.18400	

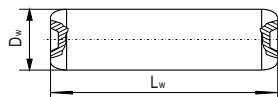

Type L

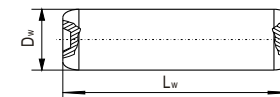

Type L

LYC Cylindrical Rollers

No.	Designations	Dimensions		Mass	Bearing No. for Reference
		D _w	L _w		
		mm		kg	
99	21×21	21	21	0.05600	NJ315Q1/S0
100	21×21.96	21	21.96	0.05870	NJ219ETN1/P54YB1
101	21×22	21	22	0.05870	NJ313E
102	21×30	21	30	0.08100	
103	21×32	21	32	0.08480	NU2313M
104	21×34	21	34	0.09020	FC4666206/SO
105	21×46	21	46	0.13400	LY-N018
106	22×12	22	12	0.03470	
107	22×21.5	22	21.5	0.06560	D2797/695G2
108	22×22	22	22	0.06560	N315M
109	22×24	22	24	0.07020	
110	22×26.5	22	26.5	0.07830	N612/C9
111	22×34	22	34	0.10100	LY-N006
112	22×48	22	48	0.14200	
113	23×34	23	34	0.10800	NNU4136X3
114	23×40	23	40	0.12800	LY-N012
115	23×48	23	48	0.15400	
116	24×12	24	12	0.04230	
117	24×16	24	16	0.05640	N224M
118	24×24	24	24	0.08200	NU2317M
119	24×36	24	36	0.12500	NU2315M
120	24×38	24	38	0.13400	FCDP5678275/HCYB
121	24×48	24	48	0.16600	FC5274200/YA
122	24×52	24	52	0.18000	2797/1010G2
123	25×24.5	25	24.5	0.09400	NU318EQ1/S0
124	25×25	25	25	0.09390	NU316EF1
125	25×27	25	27	0.10200	7397/2700G2/34
126	25×30	25	30	0.11500	NN4964K/W33
127	25×36	25	36	0.13800	NNAL6036X2M
128	25×80	25	80	0.30600	
129	26×26	26	26	0.10600	N317EF1
130	26×28	26	28	0.11200	
131	26×40	26	40	0.16500	NU636M
132	26×60	26	60	0.24700	2797/2768
133	28×27.5	28	27.5	0.13200	NU226EM
134	28×28	28	28	0.13300	NU228EL
135	28×30	28	30	0.14100	
136	28×44	28	44	0.26300	
137	30×29.5	30	29.5	0.16200	2797/870G2
138	30×30	30	30	0.16400	NU230EQ1/S0
139	30×36	30	36	0.19500	NN4968K
140	30×38	30	38	0.20700	FC6084240
141	30×40	30	40	0.12900	FC5882240A
142	30×46	30	46	0.24900	NF28/560M
143	30×47.956	30	47.956	0.26200	NJ3224X3Q1/S0
144	30×52	30	52	0.28400	FCD6084300
145	30×60	30	60	0.33000	NU3048EM
146	32×24	32	24	0.14450	N640M
147	32×32	32	32	0.19900	NU234EQ1/S0

No.	Designations	Dimensions		Mass	Bearing No. for Reference
		D _w	L _w		
		mm		kg	
148	32×36	32	36	0.22500	
149	32×51.948	32	51.948	0.32500	NJ3226X1Q1/S0
150	32×52	32	52	0.32600	NJ2320Q1/S0
151	32.15×36	32.15	36	0.22500	
152	34×34	34	34	0.23400	NU1052F1
153	34×46	34	46	0.31600	
154	34×50	34	50	0.35260	N646M
155	34×55	34	55	0.38600	NU2322EM
156	34×68	34	68	0.48100	NNTB626/YA
157	35×65	35	65	0.48700	FCD6896350
158	36×36	36	36	0.28600	NN3060K
159	38×22	38	22	0.19400	
160	38×38	38	38	0.32700	N661L
161	38×42.94	38	42.94	0.37700	LY-N013
162	38×61.952	38	61.952	0.54100	NJ2324EM/C9 SO
163	38×62	38	62	0.54100	NU2324EM
164	40×39.887	40	39.887	0.39000	N326EQ1H/P54
165	40×40	40	40	0.39000	NN3072K
166	40×58	40	58	0.55000	
167	40×65	40	65	0.63600	
168	40×65	40	65	0.63600	NU2326EM
169	40×70	40	70	0.68600	NU644M
170	40×80	40	80	0.78000	
171	45×45	45	45	0.55300	NU330EQ1/S0
172	45×75	45	75	0.92230	NU2334M
173	48×80	48	80	1.12000	NU2332EM1
174	50×50	50	50	0.76500	NU426Q1
175	52×52	52	52	0.85000	NU426M
176	52×90	52	90	1.47000	NU2336EM
177	54×54	54	54	0.97100	NJ428M

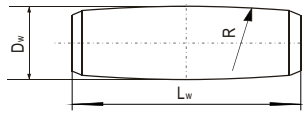

Type D

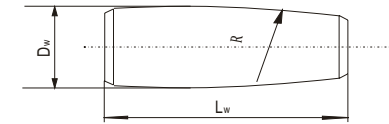

Type F

LYC Spherical Rollers

No.	Designations	Dimensions			Mass	Bearing No. for Reference
		D _w	L _w	R		
		mm			kg	
1	6.939×7.925	6.939	7.925	19.71	0.0021	20208
2	11×11.4	11	11.4	35.5	0.0089	20209
3	11.4×12	11.4	12	38	0.0090	22205CA
4	6.8×6.2	6.8	6.2	22.5	0.0017	22206C
5	8×7	8	7	27	0.0026	22210C
6	10×8.5	10	8.5	39.5	0.0050	22210CA
7	10×8	10	8	39.5	0.0048	22211C
8	11.5×9	11.5	9	44.3	0.0710	22212C
9	12.5×10	12.5	10	48.7	0.0093	22213C
10	13.5×11.5	13.5	11.5	63	0.0124	22214C
11	13.8×11.2	13.8	11.2	55	0.0127	22215C
12	13.5×11	13.5	11	58	0.0120	22216C
13	14.5×12	14.5	12	62	0.0150	22217C
14	16.6×13	16.6	13	66	0.0214	22218C
15	17.5×14.5	17.5	14.5	71.5	0.0250	22219C
16	18.5×16	18.5	16	74.5	0.0325	22220C
17	20×16.5	20	16.5	78	0.0400	22222C
18	22×20	22	20	89	0.0558	22224C
19	24×21.5	24	21.5	96	0.0750	22226C
20	25.5×24.4	25.5	24.4	103	0.0935	22228/W33
21	27.5×25.8	27.5	25.8	110.5	0.1150	22228CA/W33
22	28.5×25	28.5	25	112	0.1200	22230C
23	31×27	31	27	121	0.1460	22232CA/W33
24	32.5×30	32.5	30	129	0.1940	22238CA
25	37×34.8	37	34.8	151.5	0.2800	22244CA/W33
26	46×41	46	41	177	0.5040	22308C
27	13.3×11.9	13.3	11.9	39.5	0.0123	22309C
28	14.5×13	14.5	13	44	0.01600	22309C
29	16×14.6	16	14.6	48.5	0.02190	22310C
30	17×15.9	17	15.9	52.5	0.02690	22311C
31	18.5×17	18.5	17	57	0.03410	22312C
32	18×16.5	18	16.5	57.5	0.03060	22312CA/W33
33	19.5×17	19.5	17	61.5	0.03800	22313CA
34	20.5×19.5	20.5	19.5	66.5	0.05000	22314C
35	20.5×18.5	20.5	18.5	66	0.04430	22314CA/W33
36	22×20	22	20	70	0.05680	22315CK
37	23×22	23	22	75	0.06800	22316C
38	22.5×25	22.5	25	84	0.09470	22318C
39	27×24	27	24	84	0.10300	22318CA
40	27.5×25	27.5	25	88.5	0.10800	22319CA/W33
41	29×27.5	29	27.5	95	0.14100	22320C
42	28.8×27.25	28.8	27.25	96.5	0.13000	22320CA
43	32×30.72	32	30.72	106.5	0.18000	22322CA
44	35×32.5	35	32.5	112.5	0.23300	22324CK
45	37×33.67	37	33.67	124	0.26500	22326CA
46	40×38.5	40	38.5	133	0.36000	22328CA
47	42.5×39.63	42.5	39.63	142.5	0.41000	
48	20.5×24	20.5	24	96	0.05880	23126CA/W33
49	21×26.5	21	26.5	103	0.06770	23128CA/W33

No.	Designations	Dimensions			Mass	Bearing No. for Reference
		D _w	L _w	R		
		mm			kg	
50	23×30	23	30	113.5	0.09680	23130CA/W33
51	29.5×38.5	29.5	38.5	135	0.19300	23136C/W33
52	32×40	32	40	145	0.23700	23138CA/W33
53	37×48	37	48	168	0.37800	23144CA
54	38.5×49	38.5	49	182	0.41400	232148CA
55	17.5×20.5	17.5	20.5	72	0.03530	23218C
56	20.5×23.5	20.5	23.5	81	0.05560	23220C
57	22.5×27	22.5	27	90	0.07640	23220C
58	23.5×30	23.5	30	97	0.09170	23224C
59	25×32	25	32	84	0.11100	23226C
60	27.5×35	27.5	35	92	0.14700	23228C
61	30×38.5	30	38.5	124.5	0.19100	23230C/W33
62	33×40	33	40	141.5	0.24600	23232CA
63	34.5×44	34.5	44	151.5	0.29900	23234CA
64	35×45	35	45	159	0.31500	23236CA
65	37.5×48	37.5	48	180	0.38600	23238C
66	37.5×48	37.5	48	180	0.38600	23238C
67	12.4×20	12.4	20	100	0.17300	23238CA/C3W3YB4
68	15×23	15	23	83	0.02940	24018C
69	18.5×27	18.5	27	97	0.05000	24022C
70	20×32	20	32	115	0.07240	24028C
71	29×47	29	47	155.5	0.22200	24032C
72	35×53.5	35	53.5	195.5	0.36800	24048CA/W33
73	17×27	17	27	88.6	0.04370	24052CA
74	20×31	20	31	77.3	0.06940	24122CA/W33
75	21×32	21	32	86.1	0.07970	24124CA
76	26×39	26	39	93.3	0.14800	24128CA/W33
77	32×47	32	47	109.3	0.27100	24130CA
78	36×56	36	56	117.5	0.40300	24138CA
79	15.5×24	15.5	24	84	0.03270	24140C/W33
80	20×32	20	32	92	0.06790	4053124Y
81	28.5×44	28.5	44	124.5	0.20000	4053724Y
82	13.5×15.5	13.5	15.5	41.5	0.01530	4053732Y
83	16.5×20	16.5	20	51.5	0.02910	E-3-314
84	14×18	14	18	59	0.01980	LY-2013
85	30×40	30	40	180	0.21200	E3-315
86	18×13	18	13	64	0.02520	23052
87	20.5×29	20.5	29	100	0.06720	
88	18.5×27.5	18.5	27.5	83	0.05220	
89	20×32.5	20	32.5	97	0.07240	
90	26×41	26	41	115	0.14700	
91	13.5×11.067	13.5	11.067	55.5	0.01190	
92	14×12.065	14	12.065	59.5	0.01390	
93	17×14.688	17	14.688	68.6	0.02700	
94	20×16.7	20	16.7	77.3	0.03800	
95	23×19.328	23	19.328	86.1	0.05800	
96	25×21.149	25	21.149	93.3	0.07500	
97	29.5×24.738	29.5	24.738	109.3	0.12200	
98	31×26.572	31	26.572	117.5	0.12200	

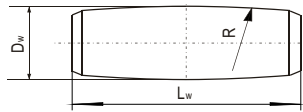

Type D

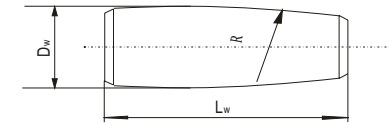

Type F

LYC Spherical Rollers

No.	Designations	Dimensions			Mass	Bearing No. for Reference
		D _w	L _w	R		
		mm			kg	
99	34×29.198	34	29.198	125.7	0.16300	
100	36×31.21	36	31.21	133.9	0.19300	
101	35.5×31.278	35.5	31.278	138.7	0.18800	
102	37×33.397	37	33.397	146.9	0.26200	22238
103	39×35.608	39	35.608	155.1	0.31700	
104	45×39.25	45	39.25	172	0.43100	
105	16.5×14.171	16.5	14.171	47.2	0.02070	
106	23×18.611	23	18.611	64.8	0.05400	
107	26×20.807	26	20.807	73.6	0.07800	
108	26×21.831	26	21.831	77.4	0.07880	
109	28.5×23.958	28.5	23.958	86	0.10100	
110	38×31.497	38	31.497	111.5	0.25500	
111	45×41.481	45	41.481	143.4	0.43000	
112	46×43.869	46	43.869	152	0.47300	
113	48×44.342	48	44.342	165.5	0.60100	
114	50×48.3	50	48.3	168	0.65000	
115	22×24.594	22	24.594	127	0.07100	
116	23×28.051	23	28.051	146	0.08800	
117	13.5×11.632	13.5	11.632	38.5	0.01220	22308
118	16.5×14.171	16.5	14.171	47.2	0.02070	22310
119	19.5×16.19	19.5	16.19	56	0.03200	22312
120	14×16.641	14	16.641	77	0.01910	23022
121	13.5×17.833	13.5	17.833	82	0.01900	23024
122	18×20.648	18	20.648	102.5	0.03940	23030
123	19×22.05	19	22.05	109.5	0.04690	23032
124	21×25.058	21	25.058	118.5	0.06490	23034
125	29×33.084	29	33.084	155	0.16300	23044
126	15.5×21.06	15.5	21.06	76	0.03000	23121
127	15.5×21.062	15.5	21.062	78	0.02800	23122
128	31×38.13	31	38.13	145.5	0.21200	23138
129	17.5×22.072	17.5	22.072	86.5	0.03930	24124
130	20.9×25.29	20.9	25.29	180	0.06280	29238
131	27×34.57	27	34.57	160.5	0.13600	29238
132	26.1×34.34	26.1	34.34	238.5	0.13300	29252
133	25.8×33.317	25.8	33.317	255.5	0.12700	29256
134	24.8×31.033	24.8	31.033	138	0.10000	29324
135	28×34.297	28	34.297	124	0.13900	29418
136	31×38.385	31	38.385	138	0.19000	29420
137	40×49.149	40	49.149	177	0.40500	29426
138	15.5×18.442	15.5	18.442	90.5	0.02730	
139	16×20.439	16	20.439	96	0.03060	
140	22.5×28.064	22.5	28.064	127	0.08310	
141	23.5×28.266	23.5	28.266	132	0.09160	
142	25×31.271	25	31.271	141	0.11400	
143	28×34.674	28	34.674	164.5	0.15900	
144	42×54.413	42	54.413	179.5	0.55000	
145	28.5×33.101	28.5	33.101	131	0.14000	
146	31×42.102	31	42.102	147.3	0.22300	
147	37×48.132	37	48.132	168	0.37800	

No.	Designations	Dimensions			Mass	Bearing No. for Reference
		D _w	L _w	R		
		mm			kg	
148	35×49.524	35	49.524	180.225	0.34800	
149	25.4×38.087	25.4	38.087	124.5	0.13800	
150	21×22.241	21	22.241	186	0.05760	
151	21×22.208	21	22.208	200	0.06160	
152	26×27.774	26	27.774	241	0.11300	
153	20.5×21.82	20.5	21.82	125.5	0.05380	
154	26×28.36	26	28.36	165	0.12300	
155	28×30.4	28	30.4	180	0.13200	
156	32×34.48	32	34.48	200	0.20900	
157	36×38.5	36	38.5	238	0.29400	
158	36×38.524	36	38.524	251	0.30000	
159	44×47.964	44	47.964	222	0.53700	
160	27.5×31.125	27.5	31.125	123	0.13600	23132K
161	40×47.212	40	47.212	163	0.43200	23240/W33
162	29.5×44.13	29.5	44.13	137.5	0.21700	24136/W33
163	33.8×32.846	33.8	32.846	106	0.20400	
164	26×33.034	26	33.034	166.5	0.13300	
165	25.4×38.087	25.4	38.087	124.5	0.13800	
166	18×24.867	18	24.867	111.5	0.05720	
167	31×33.658	31	33.658	150	0.18800	
168	35.5×60.149	35.5	60.149	169	0.41800	LZK-7

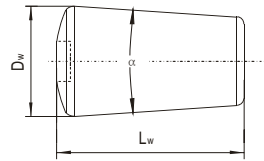

Type K

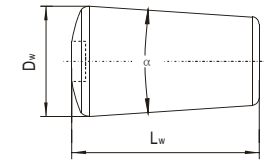

Type K

LYC Tapered Rollers

No.	Designations	Dimensions			Mass	Bearing No. for Reference
		D _w	L _w	R		
		mm			kg	
1	5.612×8.45×4°	5.612	8.45	4°	0.00146	30203
2	6.631×10.08×4°	6.631	10.08	4°	0.00242	30204
3	6.799×10.92×4°	6.799	10.92	4°	0.00274	30205
4	8.111×11.64×4°	8.111	11.64	4°	0.00420	30206
5	9.437×12.47×4°	9.437	12.47	4°	0.00615	30207
6	10.5×13.09×4°	10.5	13.09	4°	0.00803	30208
7	10.833×13.9×4°	10.833	13.9	4°	0.00906	30210
8	12.439×14.99×4°	12.439	14.99	4°	0.01300	30211
9	13.493×15.4×4°	13.493	15.4	4°	0.01570	30212
10	14.903×16.63×4°	14.903	16.63	4°	0.02080	30213
11	15.043×17.69×4°	15.043	17.69	4°	0.02240	30214
12	15.238×18.54×4°	15.238	18.54	4°	0.02400	30215
13	16.858×19.25×4°	16.858	19.25	4°	0.03060	30216
14	17.939×19.46×4°	17.939	19.46	4°	0.03530	30217
15	19.127×21.97×4°	19.127	21.97	4°	0.04510	30218
16	20.328×22.78×4°	20.328	22.78	4°	0.05290	30219
17	21.479×25.19×4°	21.479	25.19	4°	0.06510	30220
18	22.62×25.7×4°	22.62	25.7	4°	0.07380	30221
19	23.929×28.33×4°	23.929	28.33	4°	0.09100	30222
20	24.935×29.625×4°	24.935	29.625	4°	0.10300	30224
21	26.82×29.18×4°	26.82	29.18	4°	0.11800	30226
22	30.96×32.151×4°	30.96	32.151	4°	0.17500	30230
23	33.28×33.679×4°	33.28	33.679	4°	0.21200	30232
24	6.973×8.92×4°	6.973	8.92	4°	0.00241	30302
25	7.811×9.93×4°	7.811	9.93	4°	0.00337	30303
26	8.216×10.75×4°	8.216	10.75	4°	0.00402	30304
27	9.982×12.28×4°	9.982	12.28	4°	0.00682	30305
28	10.987×13.42×4°	10.987	13.42	4°	0.00903	30306
29	12.383×15.45×4°	12.383	15.45	4°	0.01320	30307
30	12.662×16.81×4°	12.662	16.81	4°	0.01490	30308
31	14.17×18.12×4°	14.17	18.12	4°	0.02020	30309
32	15.65×19.77×4°	15.65	19.77	4°	0.02690	30310
33	17.102×21.5×4°	17.102	21.5	4°	0.03500	31311
34	18.533×21.76×4°	18.533	21.76	4°	0.04180	30312
35	20.068×24.08×4°	20.068	24.08	4°	0.05420	30313
36	22.958×27.5×4°	22.958	27.5	4°	0.08100	30315
37	24.501×27.636×4°	24.501	27.636	4°	0.09340	30316
38	25.722×29.35×4°	25.722	29.35	4°	0.10900	30317
39	27.182×31.93×4°	27.182	31.93	4°	0.13200	30318
40	30.47×33.272×4°	30.47	33.272	4°	0.16400	30320
41	33.869×34.73×4°	33.869	34.73	4°	0.22600	30322
42	39.4×42.427×4°	39.4	42.427	4°	0.37200	30326
43	6.74×11.95×3°10'	6.74	11.95	3°10'	0.00300	30607
44	21.9×22.98×10°	21.9	22.98	10°	0.05490	30611
45	17×31.33×3°30'	17	31.33	3°30'	0.04930	30613
46	15.092×33.6×2°30'	15.092	33.6	2°30'	0.04230	30615
47	15.687×32.09×2°30'	15.687	32.09	2°30'	0.04400	30616
48	17×33.09×2°28'	17	33.09	2°28'	0.05370	30619
49	8.88×12.07×8°40'	8.88	12.07	8°40'	0.00466	31305

No.	Designations	Dimensions			Mass	Bearing No. for Reference
		D _w	L _w	R		
		mm			kg	
50	11.649×15.21×8°40'	11.649	15.21	8°40'	0.01020	31307
51	13.158×16.75×8°40'	13.158	16.75	8°40'	0.01440	31308
52	14.575×17.82×8°40'	14.575	17.82	8°40'	0.01890	31309
53	15.931×18.3×8°40'	15.931	18.3	8°40'	0.02350	31310
54	17.291×20.63×8°40'	17.291	20.63	8°40'	0.03100	31311
55	18.801×21.76×8°40'	18.801	21.76	8°40'	0.03880	31312
56	20.36×22.89×8°40'	20.36	22.89	8°40'	0.04810	31313
57	21.671×24.41×8°40'	21.671	24.41	8°40'	0.05810	31314
58	23.182×25.44×8°40'	23.182	25.44	8°40'	0.06960	31315
59	25.981×27.88×8°40'	25.981	27.88	8°40'	0.09640	31317
60	18.6×25.32×8°	18.6	25.32	8°	0.04360	31611
61	21×26.37×8°	21	26.37	8°	0.05880	31613
62	5.311×10.84×3°50'	5.311	10.84	3°50'	0.00160	32005
63	6.73×12.31×3°50'	6.73	12.31	3°50'	0.00300	32007
64	6.846×13.7×3°	6.846	13.7	3°	0.00353	32008
65	8.575×16.94×3°	8.575	16.94	3°	0.00685	32011
66	9.328×16.68×3°16'	9.328	16.68	3°16'	0.00799	32012
67	8.575×16.06×3°	8.575	16.06	3°	0.00650	32013
68	9.775×17.28×3°	9.775	17.28	3°	0.00920	32015
69	11.5×20.58×3°	11.5	20.58	3°	0.01510	32016
70	11.5×19.58×3°	11.5	19.58	3°	0.01440	32017
71	12.82×21.58×3°	12.82	21.58	3°	0.01980	32018
72	14.05×24.09×3°	14.05	24.09	3°	0.02650	32021
73	15.38×27.05×3°	15.38	27.05	3°	0.03560	32022
74	17.94×31.12×3°	17.94	31.12	3°	0.05580	32026
75	22.8×38.8×3°	22.8	38.8	3°	0.11300	32034
76	25.68×47.007×3°	25.68	47.007	3°	0.17200	32036
77	25.68×47.007×3°	25.68	47.007	3°	0.17200	32038
78	28×50.131×3°	28	50.131	3°	0.21900	32040
79	26×52.575×2°	26	52.575	2°	0.20200	32048
80	7.25×13.54×4°	7.25	13.54	4°	0.00380	32205
81	8.195×14.48×4°	8.195	14.48	4°	0.00520	32206
82	9.542×17.34×4°	9.542	17.34	4°	0.00846	32207
83	10.631×16.49×4°	10.631	16.49	4°	0.01020	32208
84	10.631×16.49×4°	10.631	16.49	4°	0.01020	32209
85	10.91×16.94×4°	10.91	16.94	4°	0.01100	32210
86	12.516×18.45×4°	12.516	18.45	4°	0.01580	32211
87	13.682×21.21×4°	13.682	21.21	4°	0.02170	32212
88	15.078×23.13×4°	15.078	23.13	4°	0.02870	32213
89	15.218×23.81×4°	15.218	23.81	4°	0.03010	32214
90	15.427×23.86×4°	15.427	23.86	4°	0.03100	32215
91	17.068×23.85×4°	17.068	23.85	4°	0.03830	32216
92	18.233×27.56×4°	18.233	27.56	4°	0.05010	32217
93	19.477×31.4×4°	19.477	31.4	4°	0.05460	32218
94	20.628×33.48×4°	20.628	33.48	4°	0.07740	32219
95	21.85×35.99×4°	21.85	35.99	4°	0.09320	32220
96	23×38.52×4°	23	38.52	4°	0.11000	32221
97	24.329×42.01×4°	24.329	42.01	4°	0.13400	32222
98	25.307×45.72×4°	25.307	45.72	4°	0.15700	32224

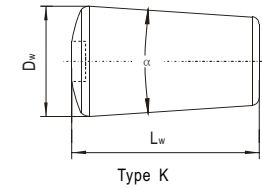
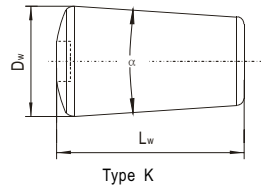

LYC Tapered Rollers

No.	Designations	Dimensions			Mass	Bearing No. for Reference
		D_w	L_w	R		
		mm			kg	
99	27.165x49.191x4°	27.165	49.191	4°	0.19500	32226
100	29.54x53.699x4°	29.54	53.699	4°	0.25100	32228
101	31.693x56.9x4°	31.693	56.9	4°	0.30700	32230
102	36.592x67.88x4°	36.592	67.88	4°	0.48600	32236
103	40.263x72.07x4°	40.263	72.07	4°	0.62700	32238
104	45.086x77.86x4°	45.086	77.86	4°	0.85400	32240
105	8.195x14.48x4°	8.195	14.48	4°	0.00523	32304
106	10.017x17.52x4°	10.017	17.52	4°	0.00946	32305
107	11.064x20.28x4°	11.064	20.28	4°	0.01330	32306
108	12.383x22.11x4°	12.383	22.11	4°	0.01820	32307
109	12.634x23.1x4°	12.634	23.1	4°	0.01970	32308
110	14.24x26.33x4°	14.24	26.33	4°	0.02850	32309
111	15.706x29.7x4°	15.706	29.7	4°	0.03900	32310
112	17.102x30.25x4°	17.102	30.25	4°	0.04760	32311
113	18.533x32.6x4°	18.533	32.6	4°	0.06020	32312
114	20.068x34.7x4°	20.068	34.7	4°	0.07520	32313
115	21.499x37.73x4°	21.499	37.73	4°	0.09390	32314
116	23.046x41.4x3°40'	23.046	41.4	3°40'	0.11800	32315
117	24.571x43.81x4°	24.571	43.81	4°	0.14200	32316
118	25.863x45.239x4°	25.863	45.239	4°	0.16300	32317
119	27.294x48.65x4°	27.294	48.65	4°	0.19500	32318
120	28.795x49.168x4°	28.795	49.168	4°	0.22000	32319
121	30.924x54.77x4°	30.924	54.77	4°	0.28200	32320
122	34.449x60.193x4°	34.449	60.193	4°	0.38500	32322
123	37.067x64.939x4°	37.067	64.939	4°	0.48100	32324
124	44x81.42x3°30'	44	81.42	3°30'	0.70000	32330
125	49.2x90.59x4°	49.2	90.59	4°	1.18000	32334
126	12.95x21.3x2°30'	12.95	21.3	2°30'	0.02020	32018X2/YA/P5
127	12.95x20.4x2°30'	12.95	20.4	2°30'	0.01940	32020X2
128	15.55x24.4x2°30'	15.55	24.4	2°30'	0.03360	32024X2/YA
129	18.15x29.1x2°30'	18.15	29.1	2°30'	0.05450	32028X2/YA
130	20.75x33.7x2°30'	20.75	33.7	2°30'	0.08250	32032X3/YA
131	25x42.066x2°	25	42.066	2°	0.15100	32038X4/YA
132	31.1x53.36x2°30'	31.1	53.36	2°30'	0.29000	32044X2
133	15.56x32.57x2°10'	15.56	32.57	2°10'	0.04450	32938
134	23x44.46x2°	23	44.46	2°	0.13400	32956
135	5.108x10x3°	5.108	10	3°	0.00150	L45449
136	5.605x11x3°7'	5.605	11	3°7'	0.00187	LM12749
137	5.701x9.2x3°26'	5.701	9.2	3°26'	0.00169	L4463
138	5.95x11.938x3°6'	5.95	11.938	3°6'	0.00160	JL69349
139	6.523x10.7x3°40'	6.523	10.7	3°40'	0.00253	LM11949
140	6.858x13.91x2°17'	6.858	13.91	2°17'	0.00369	KN102949
141	7.503x12.5x3°30'	7.503	12.5	3°30'	0.00388	LM48548
142	7.877x15.04x2°20'	7.877	15.04	2°20'	0.00530	LM104949
143	8.291x13.62x3°35'	8.291	13.62	3°35'	0.00510	LM501349
144	8.858x16.72x3°6'	8.858	16.72	3°6'	0.00722	JLM506848E
145	9.02x21.03x1°30'	9.02	21.03	1°30'	0.00980	LM119348D
146	10.415x22.41x4°57'	10.415	22.41	4°57'	0.01220	HM803146
147	12.511x27.62x4°30'	12.511	27.62	4°30'	0.02210	HM807048

No.	Designations	Dimensions			Mass	Bearing No. for Reference
		D_w	L_w	R		
		mm			kg	
148	14.5x26.51x2°	14.5	26.51	2°	0.01390	LM239504
149	15.458x31.03x2°45'	15.458	31.03	2°45'	0.04110	HM218248
150	15.875x28.649x3°30'	15.875	28.649	3°30'	0.03940	HM212047
151	16.08x33.58x2°20'	16.08	33.58	2°20'	0.04870	JM736149
152	17.648x29.95x3°36'	17.648	29.95	3°36'	0.05100	HM518445
153	19.7x25.33x7°40'	19.7	25.33	7°40'	0.04990	H913849
154	20.495x34.045x1°34'	20.495	34.045	1°34'	0.08360	LM247704
155	20.9x34.04x1°30'	20.9	34.04	1°30'	0.08700	L357004
156	22.564x41.26x1°46'	22.564	41.26	1°46'	0.12100	LM451304
157	24.57x39.1x3°26'	24.57	39.1	3°26'	0.13100	H221647NA
158	25.4x28.06x1°54'	25.4	28.06	1°54'	0.10700	LM249704
159	27.85x45.058x1°30'	27.85	45.058	1°30'	0.20500	LM263149Dw
160	28.762x50.13x3°29'40"	28.762	50.13	3°29'40"	0.22700	HM224334
161	30.346x45.614x2°40'	30.346	45.614	2°40'	0.23900	HM237504
162	33.35x45.905x2°	33.35	45.905	2°	0.29700	L770849Dw
163	11.3x23.1x4°	11.3	23.1	4°	0.01560	33209
164	11.53x24.08x3°10'	11.53	24.08	3°10'	0.01740	33113
165	14.32x31.76x2°	14.32	31.76	2°	0.03680	33021
166	14.35x34.06x1°56'	14.35	34.06	1°56'	0.03960	33022
167	15.124x30.76x3°50'	15.124	30.76	3°50'	0.03740	33213
168	15.547x32.98x2°16'	15.547	32.98	2°16'	0.04480	352936
169	17.75x29.69x2°16'	17.75	29.69	2°16'	0.05340	352122
170	19.74x43.16x3°40'	19.74	43.16	3°40'	0.08900	33219
171	25x43.48x2°	25	43.48	2°	0.15300	382952
172	29.1x53.13x3°	29.1	53.13	3°	0.25000	352136
173	30.55x31.135x2°50'	30.55	31.135	2°50'	0.16800	351044
174	31.2x30.1x3°30'	31.2	30.1	3°30'	0.17000	380641
175	31.96x53.605x2°20'	31.96	53.605	2°20'	0.31200	352138
176	32.006x41.175x2°30'	32.006	41.175	2°30'	0.24000	380652
177	37.4x63.166x3°	37.4	63.166	3°	0.49400	352144
178	5.5x8.23x2°	5.5	8.23	2°	0.00140	32908X2/P4
179	5.615x8.1x5°1'	5.615	8.1	5°1'	0.00140	LR306/46.673
180	6.196x9.32x4°	6.196	9.32	4°	0.00196	
181	6.63x10.06x3°50'	6.63	10.06	3°50'	0.00240	3506/42X3TN1-2RS
182	6.88x13.55x3°	6.88	13.55	3°	0.00350	3506/49-2LS
183	6.944x9.06x4°	6.944	9.06	4°	0.00231	3506/34X3TN1-2RS
184	7x15.55x3°	7	15.55	3°	0.00410	350610X3TN1-2RS
185	7.33x14.3x3°	7.33	14.3	3°	0.00420	32010/YB2
186	7.38x14.03x1°50'	7.38	14.03	1°50'	0.00440	32916/P5
187	7.785x13.34x3°33'20"	7.785	13.34	3°33'20"	0.00443	
188	8.105x13.05x3°	8.105	13.05	3°	0.00480	
189	8.19x13.442x13°30'	8.19	13.442	13°30'	0.00363	T135
190	8.209x16.78x3°	8.209	16.78	3°	0.00620	M201047
191	8.323x10.1x6°	8.323	10.1	6°	0.00350	LR306/40.62
192	8.585x11.85x6°	8.585	11.85	6°	0.00460	31305X2/YB2
193	8.636x15.12x4°20'	8.636	15.12	4°20'	0.00600	
194	8.697x14x4°	8.697	14	4°	0.00580	
195	8.996x17.85x3°	8.996	17.85	3°	0.00793	
196	9.066x16.77x3°30'	9.066	16.77	3°30'	0.00725	32209/YB2

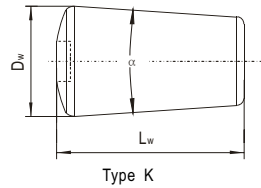

Type K

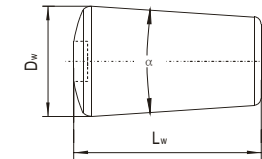

Type K

LYC Tapered Rollers

No.	Designations	Dimensions			Mass	Bearing No. for Reference
		D_w	L_w	R		
		mm			kg	
197	9.087×18.06×3°	9.087	18.06	3°	0.00818	
198	9.1×19.92×6°	9.1	19.92	6°	0.00790	32306AN
199	9.232×18.06×3°30'	9.232	18.06	3°30'	0.00845	
200	9.3×9.301×14°50'	9.3	9.301	14°50'	0.00375	LY-9004
201	9.367×15.8×5°30'	9.367	15.8	5°30'	0.00710	30306X2B/YB2
202	9.59×16.107×5°4'	9.59	16.107	5°4'	0.00800	
203	10×13.5×8°	10	13.5	8°	0.00650	
204	10.336×13.81×8°40'	10.336	13.81	8°40'	0.00725	31306/YB2
205	10.422×18.62×5°21'	10.422	18.62	5°21'	0.01040	M802048
206	10.601×22.26×3°16'	10.601	22.26	3°16'	0.01350	
207	10.634×20.94×6°	10.634	20.94	6°	0.01170	323/32
208	10.737×14.27×3°7'30"	10.737	14.27	3°7'30"	0.00930	37431A
209	10.77×22.273×3°5'	10.77	22.273	3°5'	0.01400	
210	11.35×20.65×6°	11.35	20.65	6°	0.01330	32307CN
211	11.4×21.83×3°10'	11.4	21.83	3°10'	0.01550	
212	11.92×15.63×5°	11.92	15.63	5°	0.01200	30211X2
213	12.35×25.8×3°50'	12.35	25.8	3°50'	0.02080	33910/YB2
214	12.4×22.08×2°50'	12.4	22.08	2°50'	0.01900	30616/YB2
215	12.5×29.05×1°40'	12.5	29.05	1°40'	0.02590	
216	12.7×22.87×6°	12.7	22.87	6°	0.01850	32308CN
217	13.2×29.56×2°	13.2	29.56	2°	0.02910	33019/YB2
218	13.3×22.97×2°30'	13.3	22.97	2°30'	0.02300	33114X2
219	13.752×25.5×3°10'	13.752	25.5	3°10'	0.02660	594A
220	13.8×33.9×3°30'	13.8	33.9	3°30'	0.03400	306/47
221	13.9×33.1×3°20'	13.9	33.1	3°20'	0.03390	DUF65168110
222	14.5×28.11×3°20'	14.5	28.11	3°20'	0.03220	DUF55168100
223	15.15×20.365×8°	15.15	20.365	8°	0.02300	30309X2B
224	15.47×30.27×2°10'	15.47	30.27	2°10'	0.04110	352026X2
225	15.64×30.18×1°50'	15.64	30.18	1°50'	0.04240	352936X2
226	15.76×33.11×3°14'	15.76	33.11	3°14'	0.04450	33118TN1
227	16×21.6×1°30'	16	21.6	1°30'	0.03270	D1007856
228	16.6×35.745×1°50'	16.6	35.745	1°50'	0.05620	352940X2
229	16.93×33.23×3°26'	16.93	33.23	3°26'	0.05160	LY-3026
230	17.081×31.76×3°	17.081	31.76	3°	0.05130	
231	17.58×29.08×2°	17.58	29.08	2°	0.05180	352936X2/YA4
232	17.8×36.15×3°50'	17.8	36.15	3°50'	0.06080	
233	18.278×34.13×3°10'	18.278	34.13	3°10'	0.06270	NA759
234	18.49×38.05×2°	18.49	38.05	2°	0.07400	352940X2/YA1
235	19.093×36.09×2°4'	19.093	36.09	2°4'	0.07500	352944X2
236	19.43×32.045×1°31'	19.43	32.045	1°31'	0.07080	32948/YB2
237	19.447×28.08×1°46'	19.447	28.08	1°46'	0.06180	37941K
238	19.6×42.13×3°	19.6	42.13	3°	0.08820	350620D1
239	20×35.054×2°10'	20	35.054	2°10'	0.08020	352948X2
240	20×35.1×2°	20	35.1	2°	0.07900	
241	20.8×26.56×8°	20.8	26.56	8°	0.05790	30313X2B
242	21.6×44.12×3°46'	21.6	44.12	3°46'	0.11000	33220/YB2
243	22×32.11×2°20'	22	32.11	2°20'	0.08940	M541349
244	22.8×38.76×3°	22.8	38.76	3°	0.11300	
245	23×21.775×7°52'	23	21.775	7°52'	0.06150	LY-9003

No.	Designations	Dimensions			Mass	Bearing No. for Reference
		D_w	L_w	R		
		mm			kg	
246	23.24×27.535×1°3'	23.24	27.535	1°3'	0.09220	LY-3019
247	24.3×28.456×3°30'	24.3	28.456	3°30'	0.09500	32006X2
248	24.755×31.339×8°	24.755	31.339	8°	0.09740	
249	24.805×38.106×3°	24.805	38.106	3°	0.13200	LY-3023
250	24.914×45.11×3°10'30"	24.914	45.11	3°10'30"	0.15500	
251	25×43.48×2°	25	43.48	2°	0.15600	32952X2
252	25×43.17×1°30'	25	43.17	1°30'	0.15900	352956X2
253	25.361×50.06×1°50'4"	25.361	50.06	1°50'4"	0.18500	M249749
254	25.381×50.057×1°50'4"	25.381	50.057	1°50'4"	0.18500	47T513627
255	25.505×46.078×2°16'	25.505	46.078	2°16'	0.17000	37248WF
256	25.772×48.774×1°35'	25.772	48.774	1°35'	0.18800	M257204
257	26×52.575×2°	26	52.575	2°	0.20200	352048X2
258	26.05×47.084×2°30'	26.05	47.084	2°30'	0.18000	352132X2
259	26.4×33.164×3°40'	26.4	33.164	3°40'	0.13000	LY-3029
260	26.46×48.085×2°	26.46	48.085	2°	0.19300	EE135111D
261	27.1×51.07×1°50'	27.1	51.07	1°50'	0.21600	M252304
262	27.54×38.277×2°	27.54	38.277	2°	0.17000	250KVE3601AEg
263	27.58×42.116×2°40'	27.58	42.116	2°40'	0.18200	350641D
264	28×50.568×1°30'	28	50.568	1°30'	0.23100	382968/HC C9
265	29.8×31.51×2°30'	29.8	31.51	2°30'	0.16300	382952X3
266	30×36.369×8°10'	30	36.369	8°10'	0.16600	45T202211-1F2
267	30.18×46.386×1°46'	30.18	46.386	1°46'	0.24600	EE330116D
268	30.679×47.7×2°24'	30.679	47.7	2°24'	0.25700	47T563927AwH
269	31.1×53.358×2°30'	31.1	53.358	2°30'	0.29000	382044/HCYB2
270	32.026×41.129×2°30'	32.026	41.129	2°30'	0.24300	382052X2
271	33.6×59.55×2°	33.6	59.55	2°	0.37000	352052X2
272	35.719×60.173×3°10'	35.719	60.173	3°10'	0.42700	EE420804
273	38.4×84.62×2°30'	38.4	84.62	2°30'	0.69200	46T504125GWH
274	38.52×51.15×3°	38.52	51.15	3°	0.43200	240KBE031+L
275	40.45×45.592×8°40'	40.45	45.592	8°40'	0.38300	31326DF
276	42.668×55.467×7°30'	42.668	55.467	7°30'	0.51600	LY-3018
277	43×80.23×3°20'	43	80.23	3°20'	0.60000	32244X2
278	45.72×62.23×3°2'30"	45.72	62.23	3°2'30"	0.73800	3-757
279	46×41.96×3°30'	46	41.96	3°30'	0.51500	31244
280	24.74×47.46×2°20'	24.74	47.46	2°20'	0.16300	352226X2-2RZ
281	18.557×41.965×1°48'	18.557	41.965	1°48'	0.08200	RT-641125
282	22.213×50.055×1°54'	22.213	50.055	1°54'	0.14000	RT-641134
283	10.786×13.9×4°	10.786	13.9	4°	0.00900	B3-709
284	14.261×16.1×4°	14.261	16.1	4°	0.01700	B3-710

LYC BEARING CORPORATION

- LYC Import & Export Corp.
96, Jianshe Road, Jianxi District
Luoyang, Henan, China 471003
Tel: +86 379 64984199,
64985647, 64930500
Fax: +86 379 64912225
Email: sales@lycbearing.com
[Http://www.lycbearing.com](http://www.lycbearing.com)

- LYC North America, Inc.
2600 Keslinger Road, Unit H
P.O. Box 150
Geneva, IL 60134, USA
Tel: 630-262-0601
Fax: 630-578-0712
Email: sales@lycbearings.com
[Http://www.lycbearings.com](http://www.lycbearings.com)